

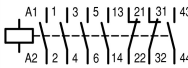

Contactor, 3p+2N/O+2N/C, 75kW/400V/AC3

Part no. DILM150-22(RDC24)
Article no. 239601
Catalog No. XTCE150G22TD

Delivery programme

Product range				Contactors
Application				Contactors for Motors
Subrange				Complete devices up to 170 A
Utilization category				AC-1: Non-inductive or slightly inductive loads, resistance furnaces NAC-3: Normal AC induction motors: starting, switch off during running AC-4: Normal AC induction motors: starting, plugging, reversing, inching
Connection technique				Screw terminals
				
Notes				Also suitable for motors with efficiency class IE3. IE3-ready devices are identified by the logo on their packaging.
Rated operational current				
AC-3				
380 V 400 V	I_e	A		150
AC-1				
Conventional free air thermal current, 3 pole, 50 - 60 Hz				
Open				
at 40 °C	$I_{th} = I_e$	A		190
enclosed	I_{th}	A		144
Conventional free air thermal current, 1 pole				
open	I_{th}	A		400
enclosed	I_{th}	A		360
Max. rating for three-phase motors, 50 - 60 Hz				
AC-3				
220 V 230 V	P	kW		48
380 V 400 V	P	kW		75
660 V 690 V	P	kW		96
AC-4				
220 V 230 V	P	kW		20
380 V 400 V	P	kW		33
660 V 690 V	P	kW		48
Contacts				
N/O = Normally open				2 N/O
N/C = Normally closed				2 NC
Instructions				Contacts to EN 50012. integrated suppressor circuit in actuating electronics with mirror contact.
Contact sequence				
Voltage AC/DC				DC operation

Technical data

General				
Standards				IEC/EN 60947, VDE 0660, UL, CSA
Lifespan, mechanical				
AC operated	Operations	$\times 10^6$		10

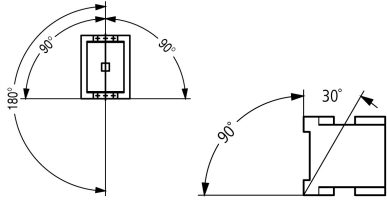
DC operated	Operations	x 10 ⁶	10
Operating frequency, mechanical			
AC operated	Operations/h		3600
DC operated	Operations/h		3600
Climatic proofing			
			Damp heat, constant, to IEC 60068-2-78 Damp heat, cyclic, to IEC 60068-2-30
Ambient temperature			
Open	°C		-25 - +60
Enclosed	°C		- 25 - 40
Storage	°C		- 40 - 80
Mounting position			
			
Mechanical shock resistance (IEC/EN 60068-2-27)			
Half-sinusoidal shock, 10 ms			
Main contacts			
N/O contact	g		10
Auxiliary contacts			
N/O contact	g		7
N/C contact	g		5
Mechanical shock resistance (IEC/EN 60068-2-27) when tabletop-mounted			
Half-sinusoidal shock, 10 ms			
Main contacts			
N/O contact	g		10
Auxiliary contacts			
N/O contact	g		7
N/C contact	g		5
Degree of Protection			
			IP00
Protection against direct contact when actuated from front (EN 50274)			
			Finger and back-of-hand proof
Weight			
AC operated	kg		2
DC operated	kg		2.1
Terminal capacity main cable			
Flexible with ferrule	mm ²		1 x (10 - 95) 2 x (10 - 70)
Stranded	mm ²		1 x (16 - 95) 2 x (16 - 70)
Solid or stranded	AWG		8...3/0
Flat conductor	Lamellenzahl x Breite x Dicke	mm	2 x (6 x 16 x 0.8)
Main cable connection screw/bolt			
			M10
Tightening torque			
			Nm 14
Terminal capacity control circuit cables			
Solid	mm ²		1 x (0.75 - 4) 2 x (0.75 - 4)
Flexible with ferrule	mm ²		1 x (0.75 - 2.5) 2 x (0.75 - 2.5)
Solid or stranded	AWG		18 - 14
Control circuit cable connection screw/bolt			
			M3.5
Tightening torque			
			Nm 1.2
Tool			
Main cable			
Hexagon socket-head spanner	SW	mm	5
Control circuit cables			

Pozidriv screwdriver	Size	2
Standard screwdriver	mm	0.8 x 5.5 1 x 6
Terminal capacity control circuit cables		
Solid	mm ²	1 x (0.75 - 2.5) 2 x (0.75 - 2.5)
Flexible	mm ²	1 x (0.75 - 2.5) 2 x (0.75 - 2.5)
Flexible with ferrule	mm ²	1 x (0.75 - 1.5) 2 x (0.75 - 1.5)
Solid or stranded	AWG	18 - 14
Tool		
Stripping length	mm	10
Screwdriver blade width	mm	3.5

Main conducting paths

Rated impulse withstand voltage	U_{imp}	V AC	8000
Overvoltage category/pollution degree			III/3
Rated insulation voltage	U_i	V AC	690
Rated operational voltage	U_e	V AC	690
Safe isolation to EN 61140			
between coil and contacts		V AC	690
between the contacts		V AC	690
Making capacity (p.f. to IEC/EN 60947)			
	U_p to 690 V	A	2100
Breaking capacity			
220 V 230 V		A	1500
380 V 400 V		A	1500
500 V		A	1500
660 V 690 V		A	1200
Short-circuit rating			
Short-circuit protection maximum fuse			
Type "2" coordination			
400 V	gG/gL 500 V	A	250
690 V	gG/gL 690 V	A	250
Type "1" coordination			
400 V	gG/gL 500 V	A	250
690 V	gG/gL 690 V	A	250

AC

AC-1			
Rated operational current			
Conventional free air thermal current, 3 pole, 50 - 60 Hz			
Open			
at 40 °C	$I_{th} = I_e$	A	190
at 50 °C	$I_{th} = I_e$	A	180
at 55 °C	$I_{th} = I_e$	A	170
at 60 °C	$I_{th} = I_e$	A	160
enclosed	I_{th}	A	144
Conventional free air thermal current, 1 pole			
open	I_{th}	A	400
enclosed	I_{th}	A	360
AC-3			
Rated operational current			
Open, 3-pole: 50 – 60 Hz			
220 V 230 V	I_e	A	150
240 V	I_e	A	150
380 V 400 V	I_e	A	150

415 V	I _e	A	150
440V	I _e	A	150
500 V	I _e	A	150
660 V 690 V	I _e	A	100
380 V 400 V	I _e	A	150
Motor rating	P	kWh	
220 V 230 V	P	kW	48
240V	P	kW	52
380 V 400 V	P	kW	75
415 V	P	kW	91
440 V	P	kW	95
500 V	P	kW	110
660 V 690 V	P	kW	96
AC-4			
Open, 3-pole: 50 – 60 Hz			
220 V 230 V	I _e	A	65
240 V	I _e	A	65
380 V 400 V	I _e	A	65
415 V	I _e	A	65
440 V	I _e	A	65
500 V	I _e	A	65
660 V 690 V	I _e	A	50
Motor rating	P	kWh	
220 V 230 V	P	kW	20
240 V	P	kW	22
380 V 400 V	P	kW	33
415 V	P	kW	39
440 V	P	kW	41
500 V	P	kW	47
660 V 690 V	P	kW	48

DC

Rated operational current, open			
DC-1			
60 V	I _e	A	160
110 V	I _e	A	160
220 V	I _e	A	90
440 V	I _e	A	4.5
DC-3			
60 V	I _e	A	160
110 V	I _e	A	160
220 V	I _e	A	40
440 V	I _e	A	1
DC-5			
60 V	I _e	A	160
110 V	I _e	A	160
220 V	I _e	A	40
440 V	I _e	A	1

Current heat loss

3-pole at I _{th}		W	30.7
Current heat loss at I _e to AC-3/400 V		W	27
Impedance per pole		mΩ	0.4

Magnet systems

Voltage tolerance		x U _c	
AC operated	Pick-up	x U _c	0.8 - 1.15

Drop-out voltage AC operated	Drop-out	x U _c	0.25 - 0.6
DC operated	Pick-up	x U _c	0.7 - 1.2
Notes			RDC 24 (U _{min} 24 V DC/U _{max} 27 V DC) Example: U _c = 0.7 x U _{min} - 1.2 x U _{max} / U _c = 0.7 x 24 V - 1.2 x 27 V DC
DC operated	Drop-out	x U _c	0.15 - 0.6
Notes			at least smoothed two-phase bridge rectifier or three-phase rectifier
Power consumption of the coil in a cold state and 1.0 x U _c			
50 Hz	Pick-up	VA	180
50 Hz	Sealing	VA	3.1
50 Hz	Sealing	W	2.1
60 Hz	Pick-up	VA	170
60 Hz	Sealing	VA	3.1
60 Hz	Sealing	W	2.1
50/60 Hz	Pick-up	VA	170 170
50/60 Hz	Sealing	VA	3.1 3.1
50/60 Hz	Sealing	W	2.1
DC operated	Pick-up	W	149
DC operated	Sealing	W	2.1
Duty factor		% DF	100
Switching times at 100 % U _c (approximate values)			
Main contacts			
AC operated			
	Closing delay	ms	28 - 33
	Opening delay	ms	35 - 41
DC operated			
	Closing delay	ms	35
	Opening delay	ms	30
	Arcing time	ms	15
	Permissible residual current with actuation of A1 - A2 by the electronics (with 0 signal).	mA	$\frac{I_n}{10}$
Lifespan, mechanical; Coil 50/60 Hz		x 10 ⁶	Mechanical lifespan at 50 Hz approx. 30% lower than under "Technical data, general"

Electromagnetic compatibility (EMC)

Emitted interference			to EN 60947-1
Interference immunity			to EN 60947-1

Design verification as per IEC/EN 61439

Technical data for design verification			
Rated operational current for specified heat dissipation	I _n	A	150
Heat dissipation per pole, current-dependent	P _{vid}	W	9
Equipment heat dissipation, current-dependent	P _{vid}	W	0
Static heat dissipation, non-current-dependent	P _{vs}	W	2.1
Heat dissipation capacity	P _{diss}	W	0
Operating ambient temperature min.		°C	-25
Operating ambient temperature max.		°C	60
IEC/EN 61439 design verification			
10.2 Strength of materials and parts			
10.2.2 Corrosion resistance			
10.2.2.1 Verification of thermal stability of enclosures			
10.2.2.2 Verification of resistance of insulating materials to normal heat			
10.2.2.3 Verification of resistance of insulating materials to abnormal heat and fire due to internal electric effects			
10.2.4 Resistance to ultra-violet (UV) radiation			
10.2.5 Lifting			
10.2.6 Mechanical impact			

10.2.7 Inscriptions		Meets the product standard's requirements.
10.3 Degree of protection of ASSEMBLIES		Does not apply, since the entire switchgear needs to be evaluated.
10.4 Clearances and creepage distances		Meets the product standard's requirements.
10.5 Protection against electric shock		Does not apply, since the entire switchgear needs to be evaluated.
10.6 Incorporation of switching devices and components		Does not apply, since the entire switchgear needs to be evaluated.
10.7 Internal electrical circuits and connections		Is the panel builder's responsibility.
10.8 Connections for external conductors		Is the panel builder's responsibility.
10.9 Insulation properties		
10.9.2 Power-frequency electric strength		Is the panel builder's responsibility.
10.9.3 Impulse withstand voltage		Is the panel builder's responsibility.
10.9.4 Testing of enclosures made of insulating material		Is the panel builder's responsibility.
10.10 Temperature rise		The panel builder is responsible for the temperature rise calculation. Eaton will provide heat dissipation data for the devices.
10.11 Short-circuit rating		Is the panel builder's responsibility. The specifications for the switchgear must be observed.
10.12 Electromagnetic compatibility		Is the panel builder's responsibility. The specifications for the switchgear must be observed.
10.13 Mechanical function		The device meets the requirements, provided the information in the instruction leaflet (IL) is observed.

Technical data ETIM 5.0

Low-voltage industrial components (EG000017) / Magnet contactor, AC-switching (EC000066)		
Electric engineering, automation, process control engineering / Low-voltage switch technology / Contactor (LV) / Power contactor, AC switching (ecl@ss8-27-37-10-03 [AAB718011])		
Rated control supply voltage U_s at AC 50HZ	V	0 - 0
Rated control supply voltage U_s at AC 60HZ	V	0 - 0
Rated control supply voltage U_s at DC	V	24 - 27
Voltage type for actuating		DC
Rated operation current I_e at AC-1, 400 V	A	190
Rated operation current I_e at AC-3, 400 V	A	150
Rated operation power at AC-3, 400 V	kW	75
Rated operation current I_e at AC-4, 400 V	A	65
Rated operation power I_e at AC-4, 400 V	kW	33
Modular version		No
Number of auxiliary contacts as normally open contact		2
Number of auxiliary contacts as normally closed contact		2
Connection type main current circuit		Screw connection
Number of normally closed contacts as main contact		0
Number of main contacts as normally open contact		3

Approvals

Product Standards		IEC/EN 60947-4-1; UL 508; CSA-C22.2 No. 14-05; CE marking
UL File No.		E29096
UL Category Control No.		NLDX
CSA File No.		012528
CSA Class No.		2411-03, 3211-04
North America Certification		UL listed, CSA certified
Specially designed for North America		No

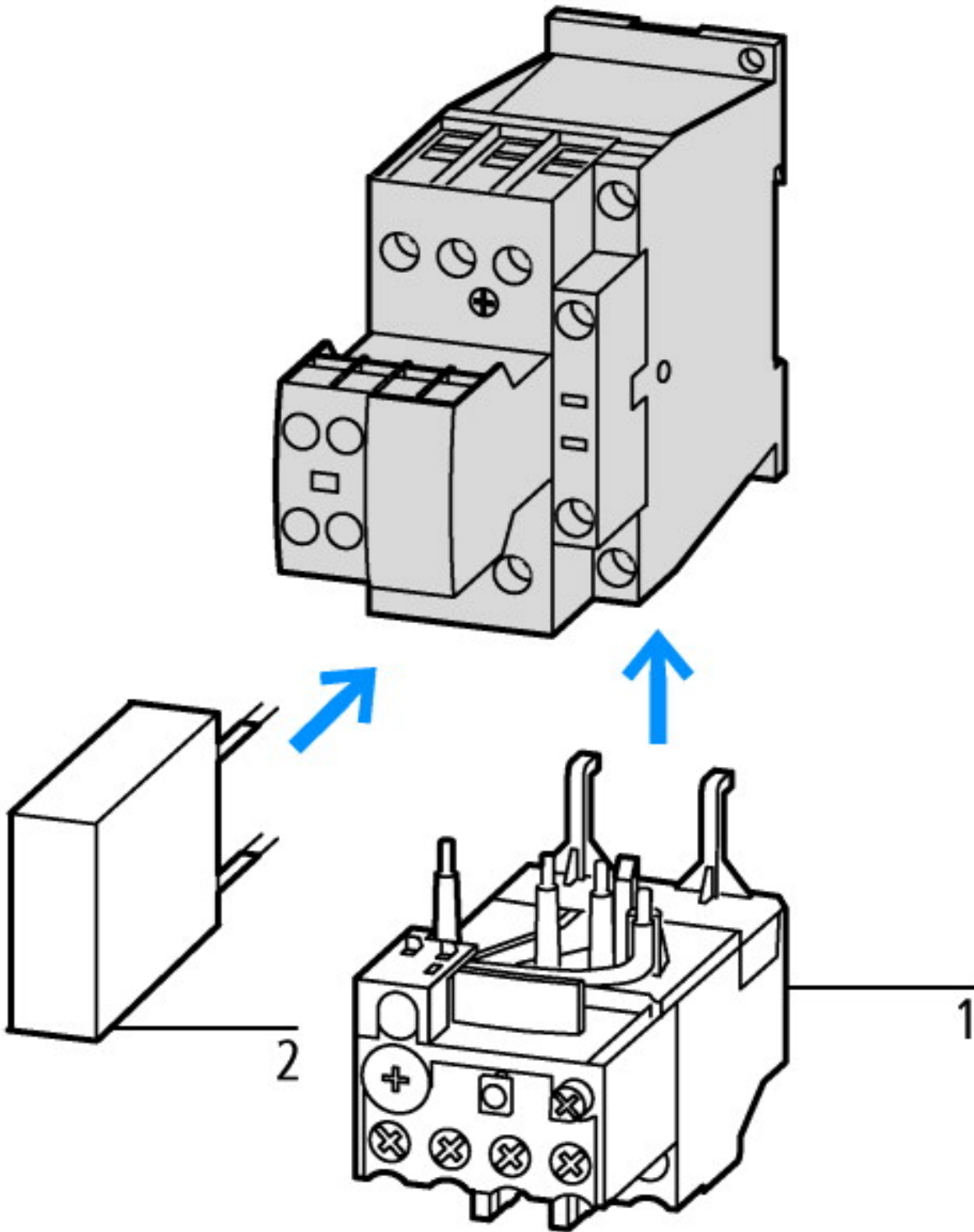

1: Overload relay
2: Suppressor



on the side: 2 x DILM820-XHI(V)11-SI; 2 x DILM820-XHI(V)11-SA
 on the side: 2 x DILM1000-XHI(V)11-SI; surface mounting: 1 x DILM150-XHIA22
 on the side: 2 x DILM1000-XHI(V)11-SI; surface mounting: 1 x DILM150-XHIA11
 on the side: 2 x DILM1000-XHI(V)11-SA; surface mounting: 1 x DILM150-XHI (4 pole)
 on the side: 2 x DILM1000-XHI(V)11-SA; surface mounting: 1 x DILM150-XHI (2 pole)

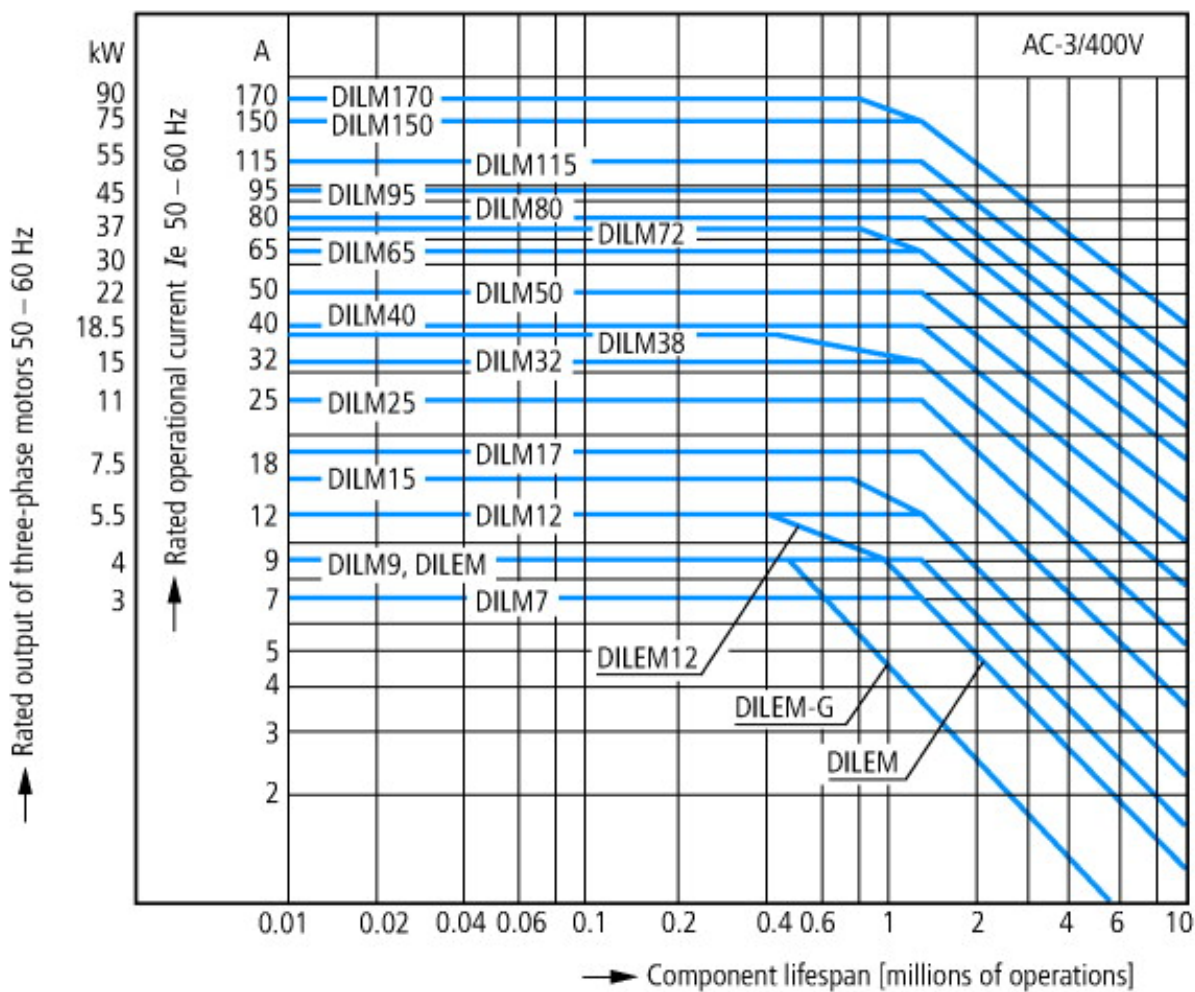

Squirrel-cage motor
 Operating characteristics
 Starting: from rest
 Stopping: after attaining full running speed
 Electrical characteristics
 Make: up to 6 x rated motor current

Break: up to 1 x rated motor current
 Utilization category
 100 % AC-3
 Typical applications
 Compressors
 Lifts
 Mixers
 Pumps
 Escalators
 Agitators
 Fans
 Conveyor belts
 Centrifuges
 Hinged flaps
 Bucket-elevators
 Air conditioning system
 General drives in manufacturing and processing machines

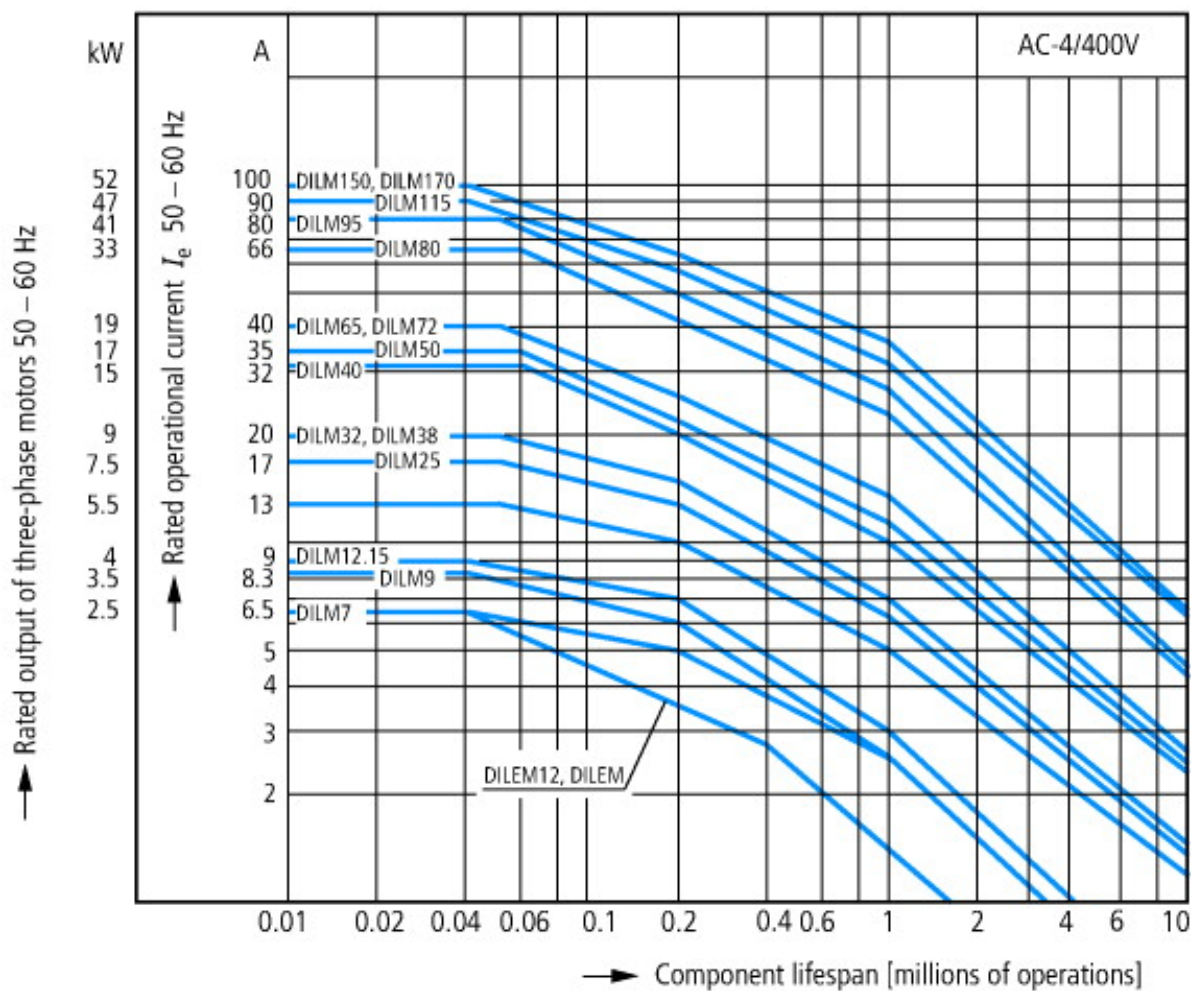

Extreme switching duty
 Squirrel-cage motor
 Operating characteristics
 Inching, plugging, reversing
 Electrical characteristics
 Make: up to 6 x rated motor current
 Break: up to 6 x rated motor current
 Utilization category
 100 % AC-4
 Typical applications
 Printing presses
 Wire-drawing machines
 Centrifuges
 Special drives for manufacturing and processing machines

Dimensions

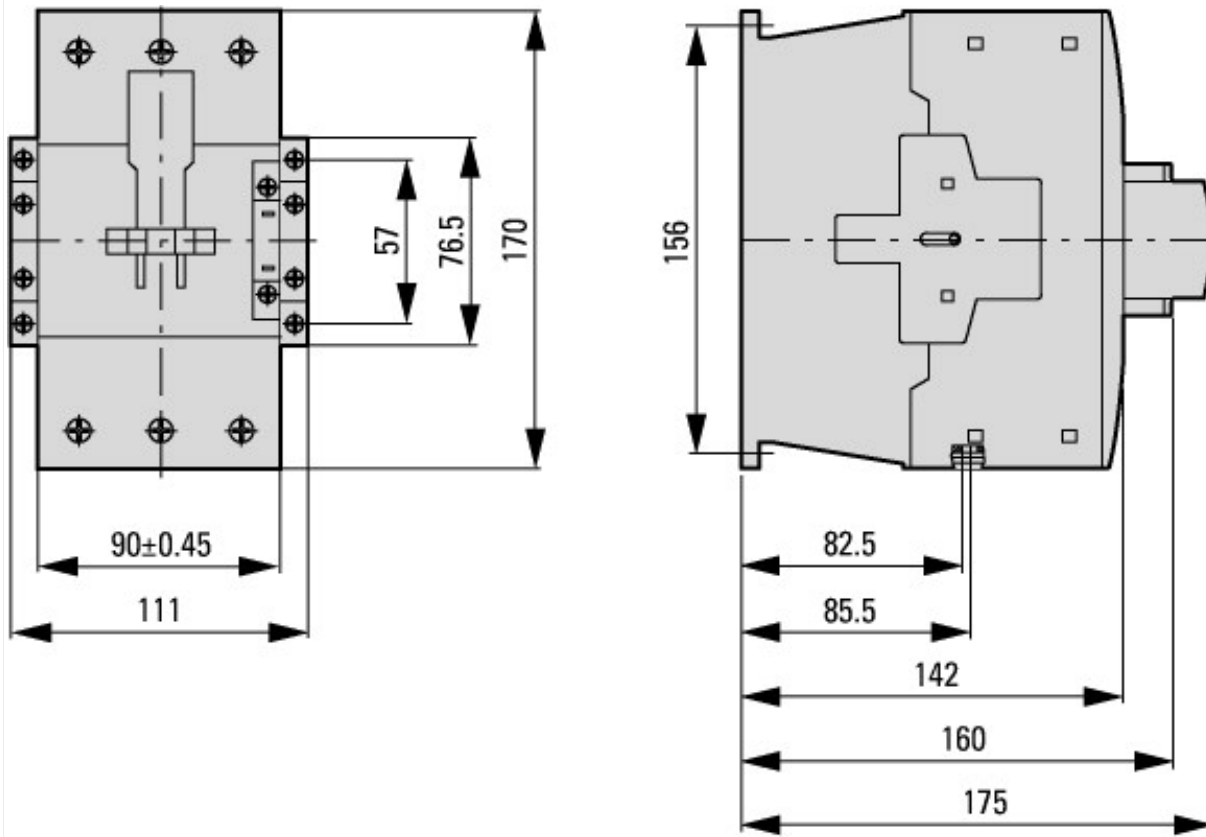

Contacteur avec module de contact auxiliaire

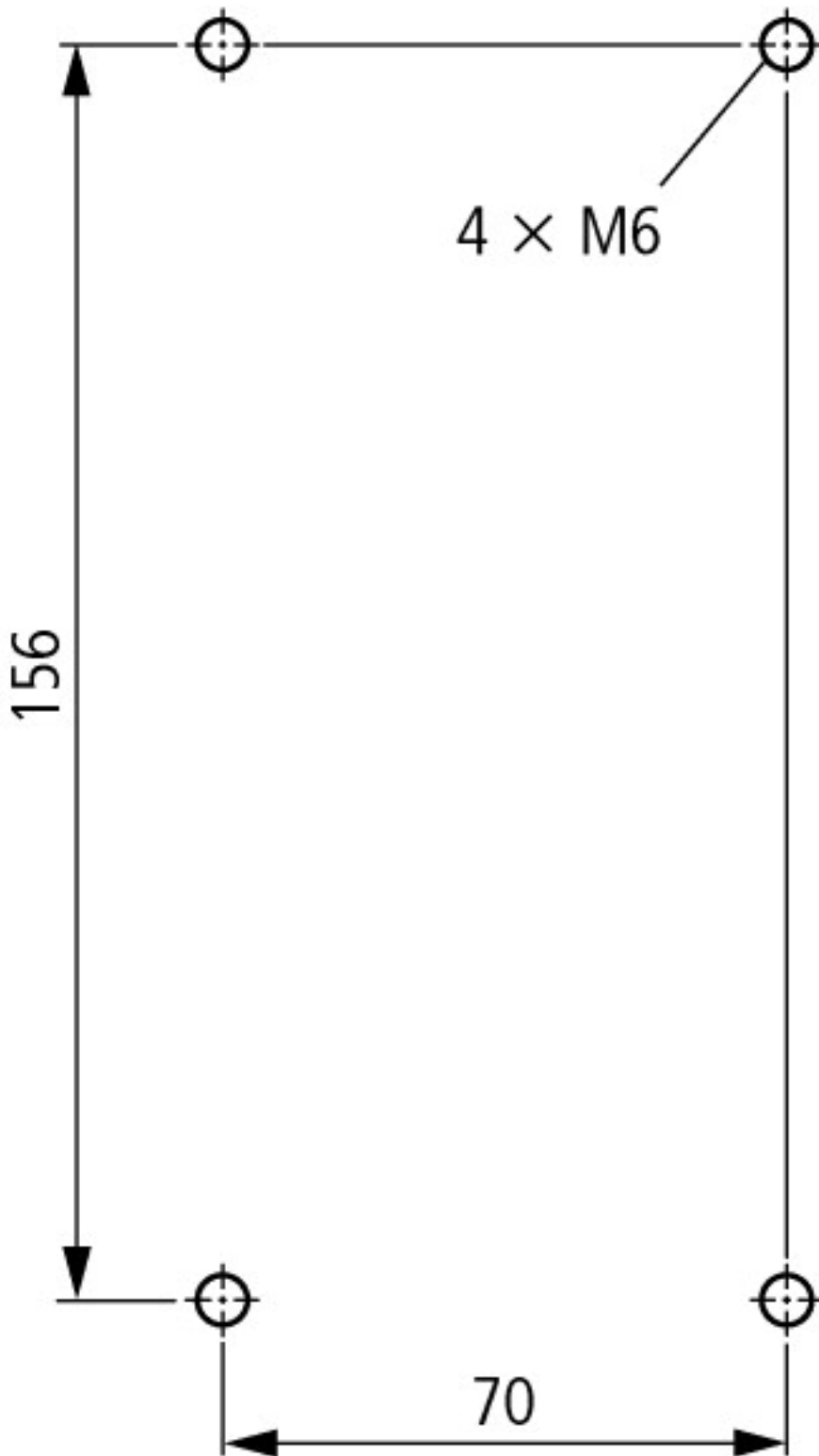

distance at side to earthed parts: 10 mm

DILM80...DILM170
 DILMC80...DILMC150
 DILMF80...DILMF150

Additional product information (links)

IL03407039Z (AWA2100-2286) Contactors

IL03407039Z (AWA2100-2286) Contactors	ftp://ftp.moeller.net/DOCUMENTATION/AWA_INSTRUCTIONS/IL03407039Z2010_10.pdf
UL/CSA: Approved rating data	http://de.ecat.moeller.net/flip-cat/?edition=HPLTE&startpage=5.84
UL/CSA: UL/CSA: Special Purpose Rating	http://de.ecat.moeller.net/flip-cat/?edition=HPLTE&startpage=5.85
Switchgear of Power Factor Correction Systems	http://www.moeller.net/binary/ver_techpapers/ver934en.pdf
X-Start - Modern Switching Installations Efficiently Fitted and Wired Securely	http://www.moeller.net/binary/ver_techpapers/ver938en.pdf
Mirror Contacts for Highly-Reliable Information Relating to Safety-Related Control Functions	http://www.moeller.net/binary/ver_techpapers/ver944en.pdf

Effect of the Cable Capacitance of Long Control Cables on the Actuation of Contactors	http://www.moeller.net/binary/ver_techpapers/ver949en.pdf
Motor starters and "Special Purpose Ratings" for the North American market	http://www.moeller.net/binary/ver_techpapers/ver953en.pdf
Switchgear for Luminaires	http://www.moeller.net/binary/ver_techpapers/ver955en.pdf
Standard Compliant and Functionally Safe Engineering Design with Mechanical Auxiliary Contacts	http://www.moeller.net/binary/ver_techpapers/ver956en.pdf
The Interaction of Contactors with PLCs	http://www.moeller.net/binary/ver_techpapers/ver957en.pdf
Busbar Component Adapters for modern Industrial control panels	http://www.moeller.net/binary/ver_techpapers/ver960en.pdf