



Contactor, 3p+2N/O+2N/C, 90kW/400V/AC3

Part no. DILM185A/22(RDC240)
Article no. 139543
Catalog No. XTCE185H22BD

Delivery programme

Product range			Contactors
Application			Contactors for Motors
Subrange			Standard devices greater than 170 A
Utilization category			AC-1: Non-inductive or slightly inductive loads, resistance furnaces NAC-3: Normal AC induction motors: starting, switch off during running AC-4: Normal AC induction motors: starting, plugging, reversing, inching
Connection technique			Screw connection
Rated operational current			
AC-1			
Conventional free air thermal current, 3 pole, 50 - 60 Hz			
Open			
at 40 °C	$I_{th} = I_e$	A	337
enclosed	I_{th}	A	245
Conventional free air thermal current, 1 pole			
open	I_{th}	A	685
enclosed	I_{th}	A	625
Max. rating for three-phase motors, 50 - 60 Hz			
AC-3			
220 V 230 V	P	kW	55
380 V 400 V	P	kW	90
660 V 690 V	P	kW	140
1000 V	P	kW	108
AC-4			
220 V 230 V	P	kW	41
380 V 400 V	P	kW	75
660 V 690 V	P	kW	102
1000 V	P	kW	77
Contact sequence			
Can be combined with auxiliary contact			DILM1000-XHI...
Actuating voltage			RDC 240: 200 - 240 V DC
Voltage AC/DC			DC operation
Contacts			
N/O = Normally open			2 N/O
N/C = Normally closed			2 NC
Auxiliary contacts			
possible variants at auxiliary contact module fitting options			on the side: 2 x DILM1000-XHI(V)11-SI; 2 x DILM1000-XHI11-SA
Side mounting auxiliary contacts			
Instructions			integrated suppressor circuit in actuating electronics 660 V, 690 V or 1000 V: not directly reversing

Technical data

General			
Standards			IEC/EN 60947, VDE 0660, UL, CSA
Lifespan, mechanical			

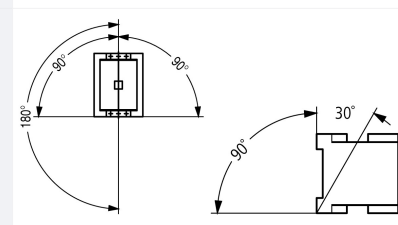
AC operated	Operations	$\times 10^6$	10
DC operated	Operations	$\times 10^6$	10
Operating frequency, mechanical			
AC operated	Operations/h		3000
DC operated	Operations/h		3000
Climatic proofing			
Damp heat, constant, to IEC 60068-2-78 Damp heat, cyclic, to IEC 60068-2-30			
Ambient temperature			
Open	°C		-40 - +60
Enclosed	°C		-40 - +40
Storage	°C		-40 - +80
Mounting position			
			
Mechanical shock resistance (IEC/EN 60068-2-27)			
Half-sinusoidal shock, 10 ms			
Main contacts			
N/O contact	g		10
Auxiliary contacts			
N/O contact	g		10
N/C contact	g		8
Degree of Protection			
IP00			
Protection against direct contact when actuated from front (EN 50274)			
Finger and back-of-hand proof with terminal shroud or terminal block			
Weight			
AC operated	kg		3.54
DC operated	kg		3.54
Weight	kg		3.54
Terminal capacity main cable			
Flexible with cable lug	mm ²		50 - 185
Stranded with cable lug	mm ²		50 - 185
Solid or stranded	AWG		1/0 - 350 MCM
Flat conductor	Lamellenzahl x Breite x Dicke	mm	Fixing with flat cable terminal or cable terminal blocks See terminal capacity for cable terminal blocks
Busbar	Breite	mm	32
Main cable connection screw/bolt			
M10			
Tightening torque			
Nm 24			
Terminal capacity control circuit cables			
Solid	mm ²		1 x (0.75 - 2.5) 2 x (0.75 - 2.5)
Flexible with ferrule	mm ²		1 x (0.75 - 2.5) 2 x (0.75 - 2.5)
Solid or stranded	AWG		2 x (18 - 12)
Control circuit cable connection screw/bolt			
M3.5			
Tightening torque			
Nm 1.2			
Tool			
Main cable			
Open-end spanner	mm		16
Control circuit cables			
Pozidriv screwdriver	Size		2
Main conducting paths			
Rated impulse withstand voltage	U_{imp}	V AC	8000
Overvoltage category/pollution degree			
III/3			
Rated insulation voltage	U_i	V AC	1000

Rated operational voltage	U _e	V AC	1000
Safe isolation to EN 61140			
between coil and contacts		V AC	500
between the contacts		V AC	500
Making capacity (p.f. to IEC/EN 60947)		A	2700
Breaking capacity			
220 V 230 V		A	2250
380 V 400 V		A	2250
500 V		A	2250
660 V 690 V		A	2250
1000 V		A	760
Component lifespan			
			AC1: See → Engineering, characteristic curves AC3: See → Engineering, characteristic curves AC4: See → Engineering, characteristic curves
Short-circuit rating			
Short-circuit protection maximum fuse			
Type "2" coordination			
400 V	gG/gL 500 V	A	315
690 V	gG/gL 690 V	A	250
1000 V	gG/gL 1000 V	A	160
Type "1" coordination			
400 V	gG/gL 500 V	A	400
690 V	gG/gL 690 V	A	315
1000 V	gG/gL 1000 V	A	200
AC			
AC-1			
Rated operational current			
Conventional free air thermal current, 3 pole, 50 - 60 Hz			
Open			
at 40 °C	I _{th} = I _e	A	337
at 50 °C	I _{th} = I _e	A	301
at 55 °C	I _{th} = I _e	A	287
at 60 °C	I _{th} = I _e	A	275
enclosed	I _{th}	A	245
Notes			At maximum permissible ambient air temperature.
Conventional free air thermal current, 1 pole			
Note			at maximum permissible ambient air temperature
open	I _{th}	A	685
enclosed	I _{th}	A	625
AC-3			
Rated operational current			
Open, 3-pole: 50 – 60 Hz			
220 V 230 V	I _e	A	185
240 V	I _e	A	185
415 V	I _e	A	185
440V	I _e	A	185
500 V	I _e	A	185
660 V 690 V	I _e	A	150
1000 V	I _e	A	76
Motor rating	P	kWh	
220 V 230 V	P	kW	55
240V	P	kW	62
380 V 400 V	P	kW	90
415 V	P	kW	110

440 V	P	kW	115
500 V	P	kW	132
660 V 690 V	P	kW	140
1000 V	P	kW	108
AC-4			
Rated operational current			
Open, 3-pole: 50 – 60 Hz			
220 V 230 V	I_e	A	136
240 V	I_e	A	136
380 V 400 V	I_e	A	136
415 V	I_e	A	136
440 V	I_e	A	136
500 V	I_e	A	136
660 V 690 V	I_e	A	110
1000 V	I_e	A	55
Motor rating			
220 V 230 V	P	kW	41
240 V	P	kW	45
380 V 400 V	P	kW	75
415 V	P	kW	80
440 V	P	kW	85
500 V	P	kW	96
660 V 690 V	P	kW	102
1000 V	P	kW	77

Condensor operation

Individual compensation, rated operational current I_e of three-phase capacitors			
Open			
up to 525 V		A	220
690 V		A	133
Max. inrush current peak		$\times I_e$	30
Component lifespan	Operations	$\times 10^6$	0.1
Max. operating frequency		Ops/h	200

DC

Rated operational current, open			
DC-1			
60 V	I_e	A	300
110 V	I_e	A	300
220 V	I_e	A	300
440 V	I_e	A	11
DC-3			
60 V	I_e	A	300
110 V	I_e	A	300
220 V	I_e	A	300
DC-5			
60 V	I_e	A	300
110 V	I_e	A	300
220 V	I_e	A	300

Current heat loss

3-pole at I_{th}		W	34
Current heat loss at I_e to AC-3/400 V		W	16

Magnet systems

Voltage tolerance			
U_C		$\times U_C$	200 - 240 V DC
DC operated	Pick-up	$\times U_C$	$0.7 \times U_{C \min} - 1.2 \times U_{C \max}$

DC operated	Drop-out	x U _c	0.15 x U _{c min} - 0.6 x U _{c max}
Power consumption of the coil in a cold state and 1.0 x U _c			
Pull-in power	Pick-up	VA	210
Pull-in power	Pick-up	W	180
Sealing power	Sealing	VA	2.6
Sealing power	Sealing	W	2.1
Duty factor		% DF	100
Switching times at 100 % U _c (approximate values)			
Main contacts			
Closing delay		ms	60
Opening delay		ms	40
PLC signal level (A3 - A4) to IEC/EN 61131-2 (type 2)			
High		V	15
Low		V	5

Electromagnetic compatibility (EMC)

Electromagnetic compatibility		This product is designed for operation in industrial environments (environment 2). The use in residential environments (environment 1) could cause electrical interference so that addition suppression must be planned.
-------------------------------	--	--

Design verification as per IEC/EN 61439

Technical data for design verification			
Rated operational current for specified heat dissipation	I _n	A	185
Heat dissipation per pole, current-dependent	P _{vid}	W	5.33
Equipment heat dissipation, current-dependent	P _{vid}	W	0
Static heat dissipation, non-current-dependent	P _{vs}	W	2.1
Heat dissipation capacity	P _{diss}	W	0
Operating ambient temperature min.		°C	-40
Operating ambient temperature max.		°C	60
IEC/EN 61439 design verification			
10.2 Strength of materials and parts			
10.2.2 Corrosion resistance			Meets the product standard's requirements.
10.2.3.1 Verification of thermal stability of enclosures			Meets the product standard's requirements.
10.2.3.2 Verification of resistance of insulating materials to normal heat			Meets the product standard's requirements.
10.2.3.3 Verification of resistance of insulating materials to abnormal heat and fire due to internal electric effects			Meets the product standard's requirements.
10.2.4 Resistance to ultra-violet (UV) radiation			Meets the product standard's requirements.
10.2.5 Lifting			Does not apply, since the entire switchgear needs to be evaluated.
10.2.6 Mechanical impact			Does not apply, since the entire switchgear needs to be evaluated.
10.2.7 Inscriptions			Meets the product standard's requirements.
10.3 Degree of protection of ASSEMBLIES			Does not apply, since the entire switchgear needs to be evaluated.
10.4 Clearances and creepage distances			Meets the product standard's requirements.
10.5 Protection against electric shock			Does not apply, since the entire switchgear needs to be evaluated.
10.6 Incorporation of switching devices and components			Does not apply, since the entire switchgear needs to be evaluated.
10.7 Internal electrical circuits and connections			Is the panel builder's responsibility.
10.8 Connections for external conductors			Is the panel builder's responsibility.
10.9 Insulation properties			
10.9.2 Power-frequency electric strength			Is the panel builder's responsibility.
10.9.3 Impulse withstand voltage			Is the panel builder's responsibility.
10.9.4 Testing of enclosures made of insulating material			Is the panel builder's responsibility.
10.10 Temperature rise			The panel builder is responsible for the temperature rise calculation. Eaton will provide heat dissipation data for the devices.
10.11 Short-circuit rating			Is the panel builder's responsibility. The specifications for the switchgear must be observed.
10.12 Electromagnetic compatibility			Is the panel builder's responsibility. The specifications for the switchgear must be observed.
10.13 Mechanical function			The device meets the requirements, provided the information in the instruction leaflet (IL) is observed.

Technical data ETIM 5.0

Low-voltage industrial components (EG000017) / Magnet contactor, AC-switching (EC000066)			
Electric engineering, automation, process control engineering / Low-voltage switch technology / Contactor (LV) / Power contactor, AC switching (ecl@ss8-27-37-10-03 [AAB718011])			
Rated control supply voltage Us at AC 50HZ	V		0 - 0
Rated control supply voltage Us at AC 60HZ	V		0 - 0
Rated control supply voltage Us at DC	V		200 - 240
Voltage type for actuating			DC
Rated operation current Ie at AC-1, 400 V	A		337
Rated operation current Ie at AC-3, 400 V	A		185
Rated operation power at AC-3, 400 V	kW		90
Rated operation current Ie at AC-4, 400 V	A		136
Rated operation power Ie at AC-4, 400 V	kW		75
Modular version			No
Number of auxiliary contacts as normally open contact			2
Number of auxiliary contacts as normally closed contact			2
Connection type main current circuit			Rail connection
Number of normally closed contacts as main contact			3
Number of main contacts as normally open contact			0

Approvals

Product Standards			IEC/EN 60947-4-1; UL508;CSA-C22.2 No.14-05; CE marking
UL File No.			E29096
UL Category Control No.			NLDX
CSA File No.			2389068
CSA Class No.			3211-04
North America Certification			UL listed, CSA certified
Specially designed for North America			No

Characteristics

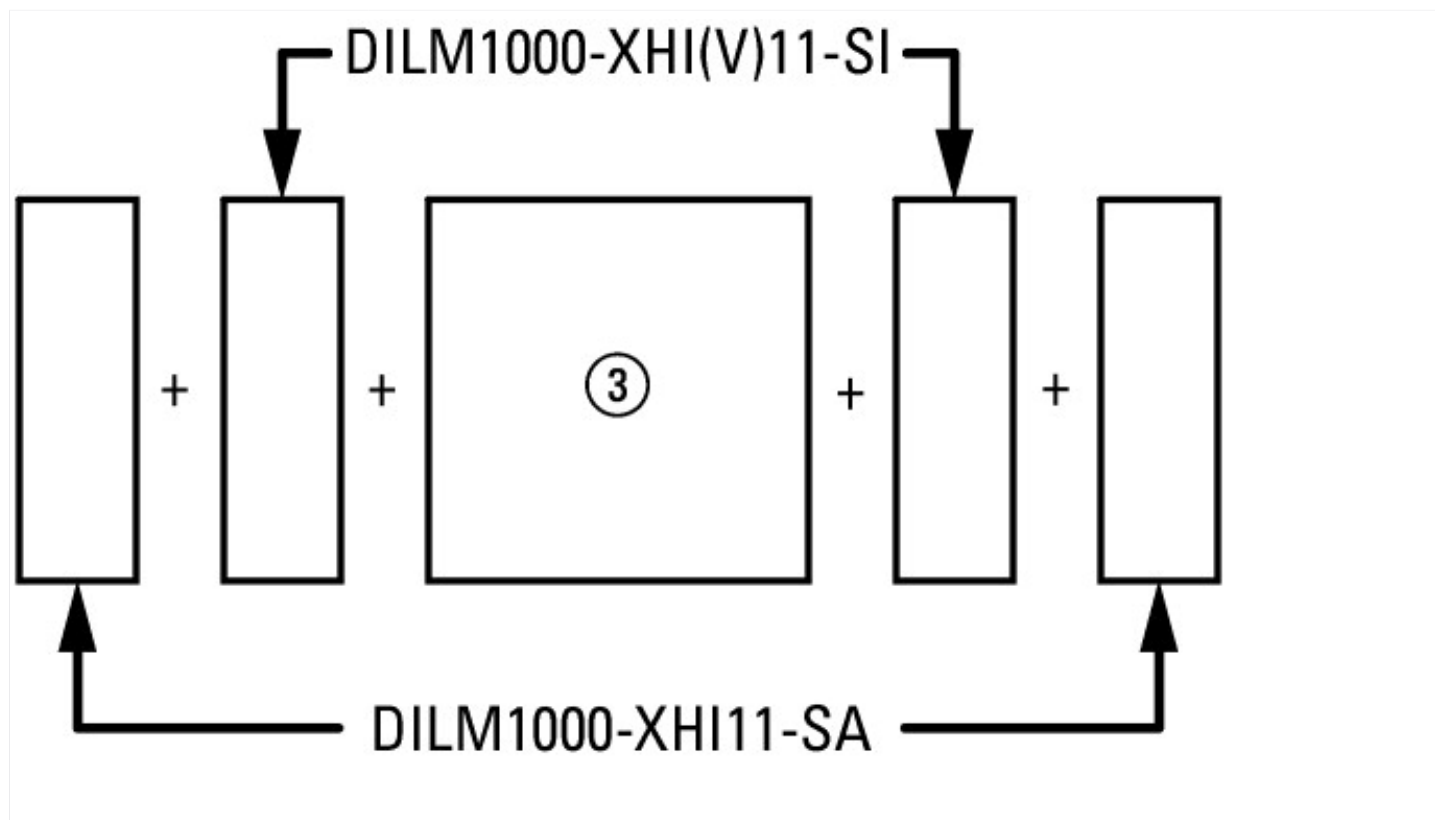

on the side: 2 x DILM1000-XHI(V)11-SI; 2 x DILM1000-XHI11-SA

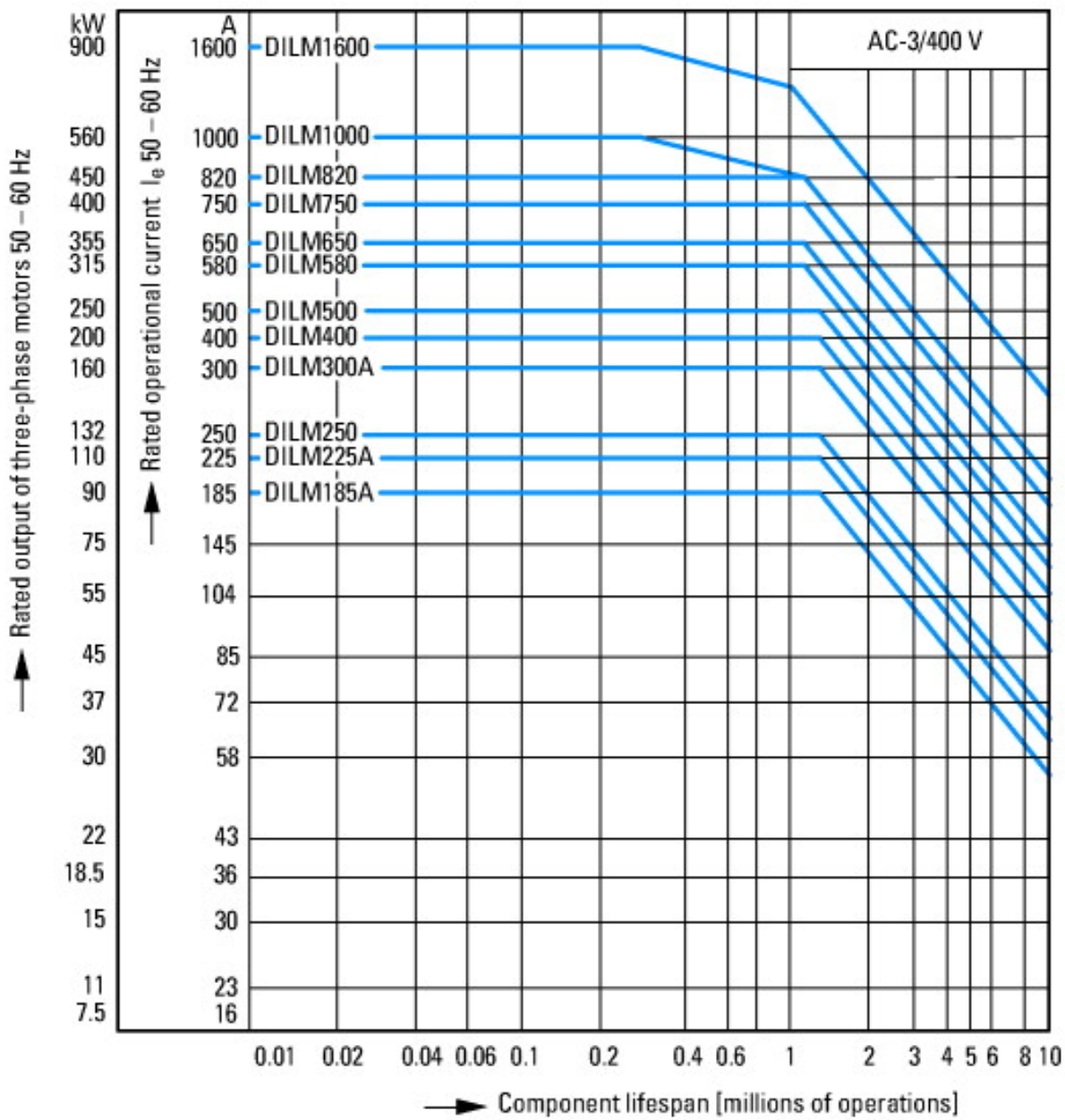

- Normal switching duty
- Normal AC induction motor
- Operating characteristics
- Switch on: from stop
- Switch off: during run
- Electrical characteristics:
- Switch on: up to 6 x Rated motor current
- Switch off: up to 1 x Rated motor current
- Utility category
- 100 % AC-3
- Typical Applications
- Compressors
- Lifts
- Mixers
- Pumps
- Escalators
- Agitators
- fan
- Conveyor belts
- Centrifuges
- Hinged flaps
- Bucket-elevator
- Air-conditioning systems
- General drives for manufacturing and processing machines

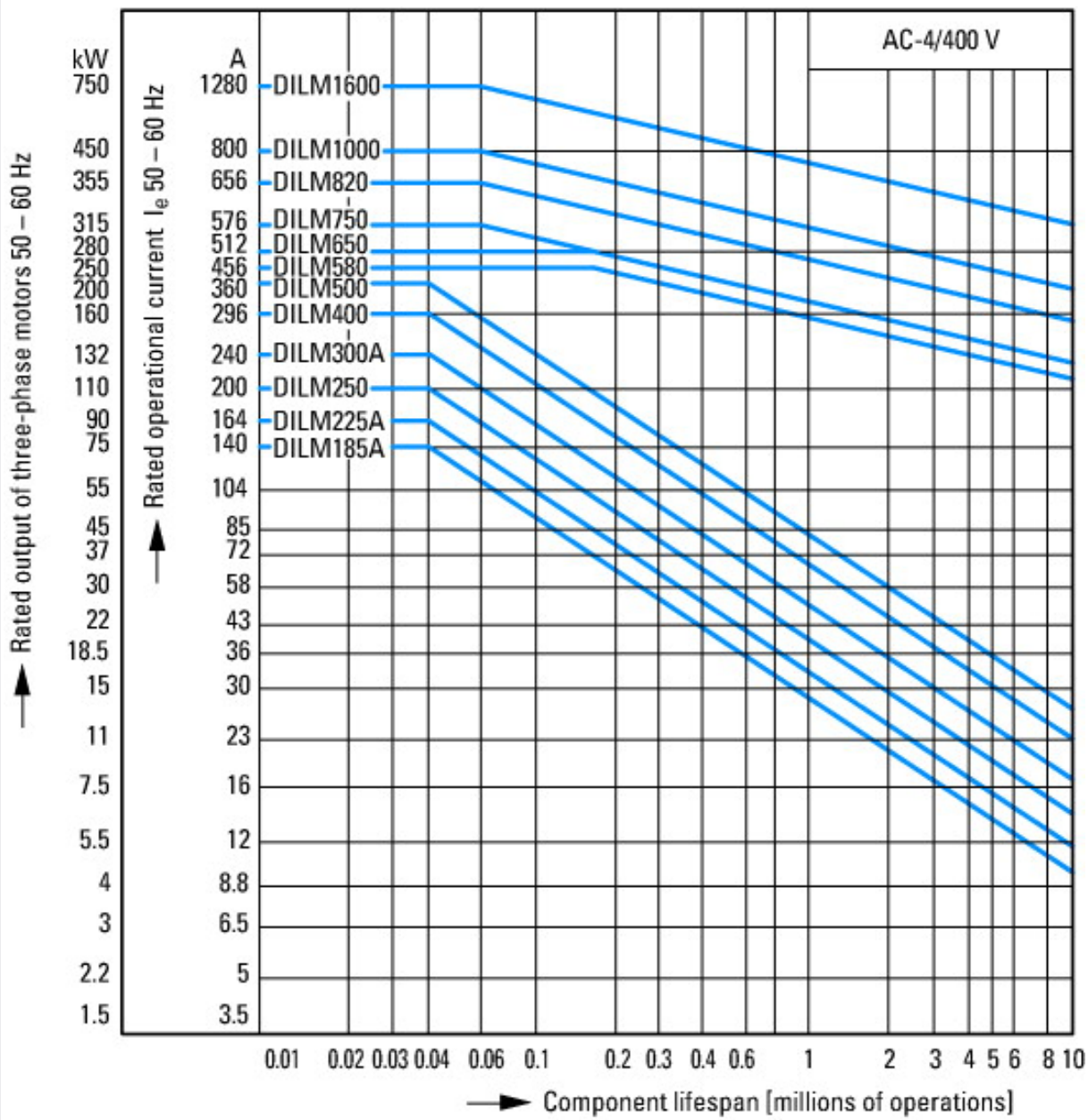

Extreme switching duty
 Squirrel-cage motor
 Operating characteristics
 Inching, plugging, reversing
 Electrical characteristics
 Make: up to 6 x rated motor current
 Break: up to 6 x rated motor current
 Utilization category
 100 % AC-4
 Typical applications
 Printing presses
 Wire-drawing machines
 Centrifuges
 Special drives for manufacturing and processing machines

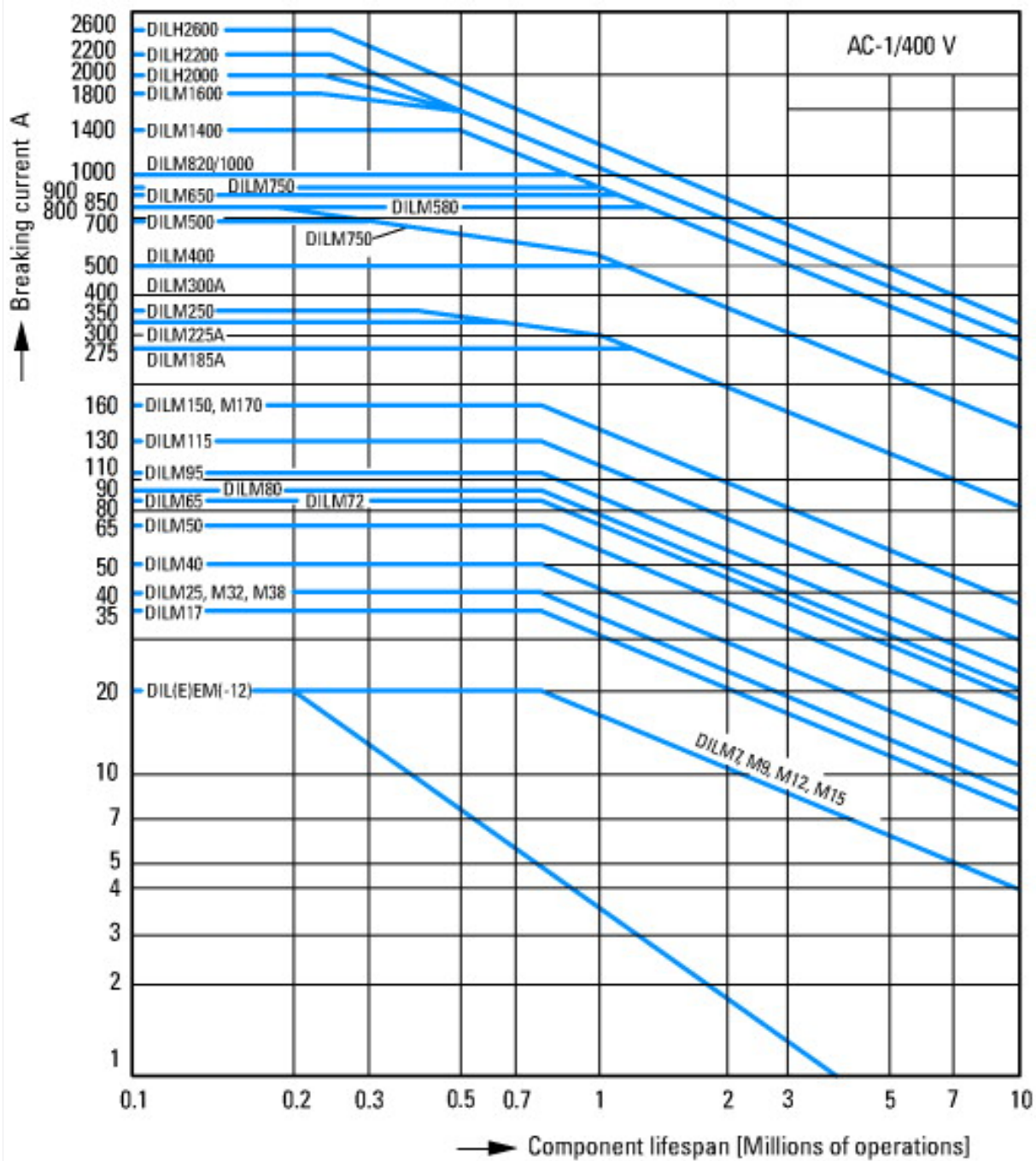

Switching duty for non-motor loads, 3-pole, 4-pole
 Operating characteristics
 Non-inductive or slightly inductive loads
 Electrical characteristics
 Make: 1 x rated current
 Break: 1 x rated current
 Utilization category
 100 % AC-1
 Typical applications
 Electric heat

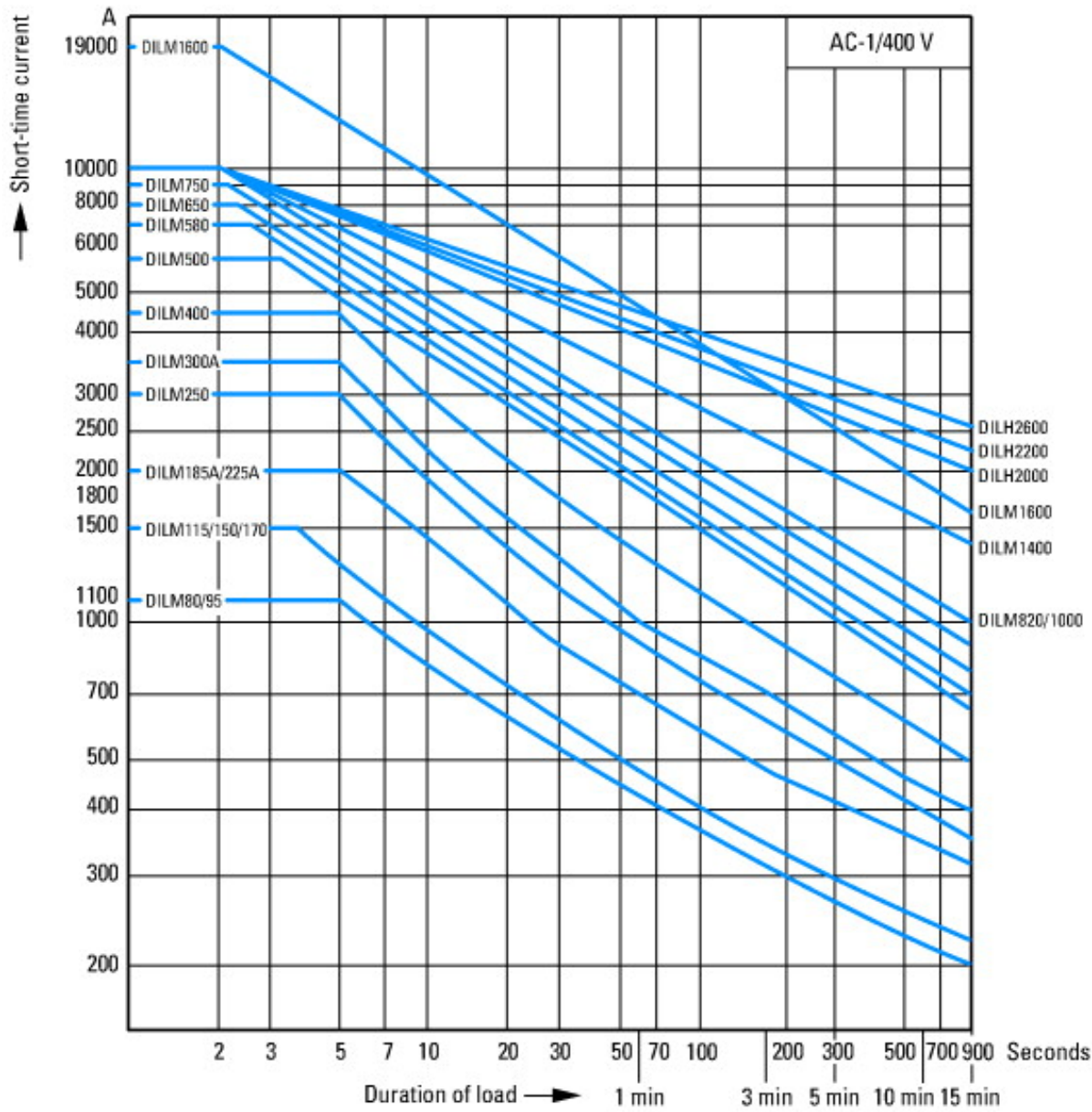

Short-time loading, 3-pole
Time interval between two loading cycles: 15 minutes

Dimensions

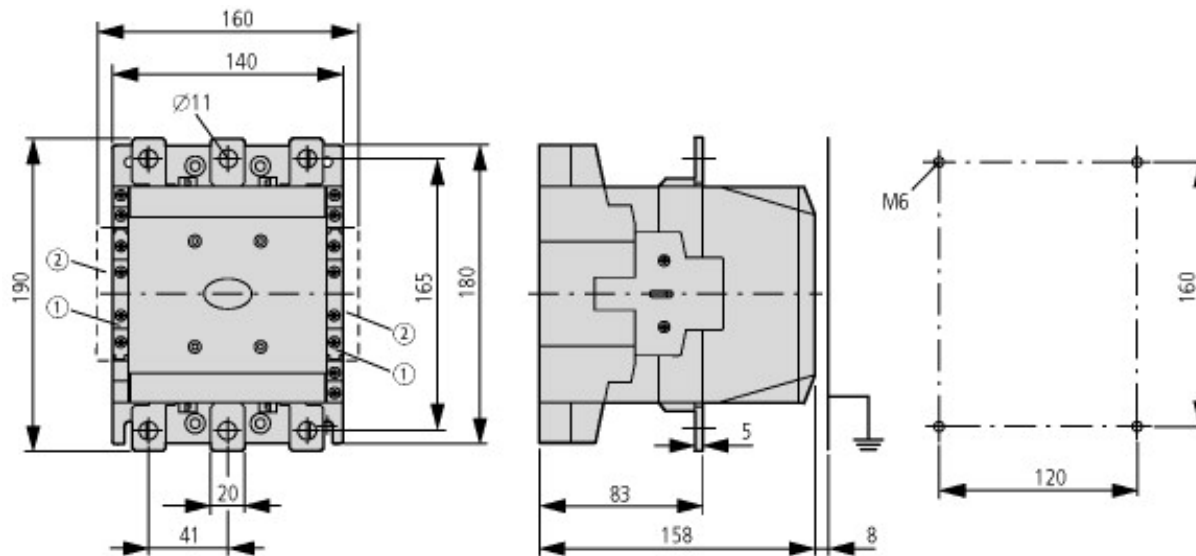

① DILM1000-XHI(V)11-SI

② DILM1000-XHI11-SA

DILM185...DILM500
DILMC185-S...DILMC500-S

Additional product information (links)

IL03406001Z Contactors

IL03406001Z Contactors	ftp://ftp.moeller.net/DOCUMENTATION/AWA_INSTRUCTIONS/IL03406001Z2010_06.pdf
Switchgear of Power Factor Correction Systems	http://www.moeller.net/binary/ver_techpapers/ver934en.pdf
X-Start - Modern Switching Installations Efficiently Fitted and Wired Securely	http://www.moeller.net/binary/ver_techpapers/ver938en.pdf
Mirror Contacts for Highly-Reliable Information Relating to Safety-Related Control Functions	http://www.moeller.net/binary/ver_techpapers/ver944en.pdf
Effect of the Cable Capacitance of Long Control Cables on the Actuation of Contactors	http://www.moeller.net/binary/ver_techpapers/ver949en.pdf
Motor starters and "Special Purpose Ratings" for the North American market	http://www.moeller.net/binary/ver_techpapers/ver953en.pdf
Switchgear for Luminaires	http://www.moeller.net/binary/ver_techpapers/ver955en.pdf
Standard Compliant and Functionally Safe Engineering Design with Mechanical Auxiliary Contacts	http://www.moeller.net/binary/ver_techpapers/ver956en.pdf
The Interaction of Contactors with PLCs	http://www.moeller.net/binary/ver_techpapers/ver957en.pdf
Busbar Component Adapters for modern Industrial control panels	http://www.moeller.net/binary/ver_techpapers/ver960en.pdf