



Contactor, 3p+2N/O+2N/C, 110kW/400V/AC3

Part no. DILM225A/22(RAC120)
Article no. 139546
Catalog No. XTCE225H22A

Delivery programme

| | | | |
|---|----------------|----|--|
| Product range | | | Contactors |
| Application | | | Contactors for Motors |
| Subrange | | | Standard devices greater than 170 A |
| Utilization category | | | AC-1: Non-inductive or slightly inductive loads, resistance furnaces NAC-3: Normal AC induction motors: starting, switch off during running AC-4: Normal AC induction motors: starting, plugging, reversing, inching |
| Connection technique | | | Screw connection |
| Rated operational current | | | |
| AC-1 | | | |
| Conventional free air thermal current, 3 pole, 50 - 60 Hz | | | |
| Open | | | |
| at 40 °C | $I_{th} = I_e$ | A | 386 |
| enclosed | I_{th} | A | 275 |
| Conventional free air thermal current, 1 pole | | | |
| open | I_{th} | A | 707 |
| enclosed | I_{th} | A | 636 |
| Max. rating for three-phase motors, 50 - 60 Hz | | | |
| AC-3 | | | |
| 220 V 230 V | P | kW | 70 |
| 380 V 400 V | P | kW | 110 |
| 660 V 690 V | P | kW | 150 |
| 1000 V | P | kW | 108 |
| AC-4 | | | |
| 220 V 230 V | P | kW | 51 |
| 380 V 400 V | P | kW | 90 |
| 660 V 690 V | P | kW | 110 |
| 1000 V | P | kW | 77 |
| Contact sequence | | | |
| Can be combined with auxiliary contact | | | DILM1000-XHI... |
| Actuating voltage | | | RAC 120: 100 - 120 V 50/60 Hz |
| Voltage AC/DC | | | AC operation |
| Contacts | | | |
| N/O = Normally open | | | 2 N/O |
| N/C = Normally closed | | | 2 NC |
| Auxiliary contacts | | | |
| possible variants at auxiliary contact module fitting options | | | on the side: 2 x DILM1000-XHI(V)11-SI; 2 x DILM1000-XHI11-SA |
| Side mounting auxiliary contacts | | | |
| Instructions | | | integrated suppressor circuit in actuating electronics 660 V, 690 V or 1000 V: not directly reversing |

Technical data

| | | | |
|----------------------|--|--|---------------------------------|
| General | | | |
| Standards | | | IEC/EN 60947, VDE 0660, UL, CSA |
| Lifespan, mechanical | | | |

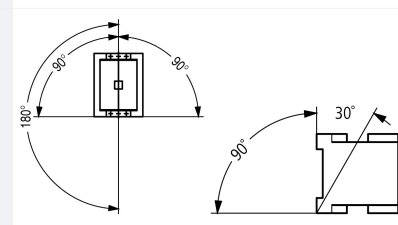
| | | | |
|--|-------------------------------------|---------------|---|
| AC operated | Operations | $\times 10^6$ | 10 |
| DC operated | Operations | $\times 10^6$ | 10 |
| Operating frequency, mechanical | | | |
| AC operated | Operations/h | | 3000 |
| DC operated | Operations/h | | 3000 |
| Climatic proofing | | | |
| Damp heat, constant, to IEC 60068-2-78 Damp heat, cyclic, to IEC 60068-2-30 | | | |
| Ambient temperature | | | |
| Open | °C | | -40 - +60 |
| Enclosed | °C | | -40 - +40 |
| Storage | °C | | -40 - +80 |
| Mounting position | | | |
|  | | | |
| Mechanical shock resistance (IEC/EN 60068-2-27) | | | |
| Half-sinusoidal shock, 10 ms | | | |
| Main contacts | | | |
| N/O contact | g | | 10 |
| Auxiliary contacts | | | |
| N/O contact | g | | 10 |
| N/C contact | g | | 8 |
| Degree of Protection | | | |
| IP00 | | | |
| Protection against direct contact when actuated from front (EN 50274) | | | |
| Finger and back-of-hand proof with terminal shroud or terminal block | | | |
| Weight | | | |
| AC operated | kg | | 3.54 |
| DC operated | kg | | 3.54 |
| Weight | kg | | 3.54 |
| Terminal capacity main cable | | | |
| Flexible with cable lug | mm ² | | 50 - 185 |
| Stranded with cable lug | mm ² | | 70 - 185 |
| Solid or stranded | AWG | | 2/0 - 250 MCM |
| Flat conductor | Lamellenzahl x Breite x Dicke | mm | Fixing with flat cable terminal or cable terminal blocks See terminal capacity for cable terminal blocks |
| Busbar | Breite | mm | 32 |
| Main cable connection screw/bolt | | | |
| M10 | | | |
| Tightening torque | | | |
| Nm 24 | | | |
| Terminal capacity control circuit cables | | | |
| Solid | mm ² | | 1 x (0.75 - 2.5) 2 x (0.75 - 2.5) |
| Flexible with ferrule | mm ² | | 1 x (0.75 - 2.5) 2 x (0.75 - 2.5) |
| Solid or stranded | AWG | | 2 x (18 - 12) |
| Control circuit cable connection screw/bolt | | | |
| M3.5 | | | |
| Tightening torque | | | |
| Nm 1.2 | | | |
| Tool | | | |
| Main cable | | | |
| Open-end spanner | mm | | 16 |
| Control circuit cables | | | |
| Pozidriv screwdriver | Size | | 2 |
| Main conducting paths | | | |
| Rated impulse withstand voltage | U_{imp} | V AC | 8000 |
| Overvoltage category/pollution degree | | | III/3 |
| Rated insulation voltage | U_i | V AC | 1000 |

| | | | |
|---|----------------------------------|------|---|
| Rated operational voltage | U _e | V AC | 1000 |
| Safe isolation to EN 61140 | | | |
| between coil and contacts | | V AC | 500 |
| between the contacts | | V AC | 500 |
| Making capacity (p.f. to IEC/EN 60947) | | A | 2700 |
| Breaking capacity | | | |
| 220 V 230 V | | A | 2250 |
| 380 V 400 V | | A | 2250 |
| 500 V | | A | 2250 |
| 660 V 690 V | | A | 2250 |
| 1000 V | | A | 760 |
| Component lifespan | | | |
| | | | AC1: See → Engineering, characteristic curves AC3: See → Engineering, characteristic curves AC4: See → Engineering, characteristic curves |
| Short-circuit rating | | | |
| Short-circuit protection maximum fuse | | | |
| Type "2" coordination | | | |
| 400 V | gG/gL 500 V | A | 315 |
| 690 V | gG/gL 690 V | A | 250 |
| 1000 V | gG/gL 1000 V | A | 160 |
| Type "1" coordination | | | |
| 400 V | gG/gL 500 V | A | 400 |
| 690 V | gG/gL 690 V | A | 315 |
| 1000 V | gG/gL 1000 V | A | 200 |
| AC | | | |
| AC-1 | | | |
| Rated operational current | | | |
| Conventional free air thermal current, 3 pole, 50 - 60 Hz | | | |
| Open | | | |
| at 40 °C | I _{th} = I _e | A | 386 |
| at 50 °C | I _{th} = I _e | A | 345 |
| at 55 °C | I _{th} = I _e | A | 329 |
| at 60 °C | I _{th} = I _e | A | 315 |
| enclosed | I _{th} | A | 275 |
| Notes | | | At maximum permissible ambient air temperature. |
| Conventional free air thermal current, 1 pole | | | |
| Note | | | at maximum permissible ambient air temperature |
| open | I _{th} | A | 707 |
| enclosed | I _{th} | A | 636 |
| AC-3 | | | |
| Rated operational current | | | |
| Open, 3-pole: 50 – 60 Hz | | | |
| 220 V 230 V | I _e | A | 225 |
| 240 V | I _e | A | 225 |
| 415 V | I _e | A | 225 |
| 440V | I _e | A | 225 |
| 500 V | I _e | A | 225 |
| 660 V 690 V | I _e | A | 160 |
| 1000 V | I _e | A | 76 |
| Motor rating | P | kWh | |
| 220 V 230 V | P | kW | 70 |
| 240V | P | kW | 75 |
| 380 V 400 V | P | kW | 110 |
| 415 V | P | kW | 132 |

| | | | |
|---------------------------|----------------|----|-----|
| 440 V | P | kW | 138 |
| 500 V | P | kW | 160 |
| 660 V 690 V | P | kW | 150 |
| 1000 V | P | kW | 108 |
| AC-4 | | | |
| Rated operational current | | | |
| Open, 3-pole: 50 – 60 Hz | | | |
| 220 V 230 V | I _e | A | 164 |
| 240 V | I _e | A | 164 |
| 380 V 400 V | I _e | A | 164 |
| 415 V | I _e | A | 164 |
| 440 V | I _e | A | 164 |
| 500 V | I _e | A | 164 |
| 660 V 690 V | I _e | A | 120 |
| 1000 V | I _e | A | 55 |
| Motor rating | | | |
| 220 V 230 V | P | kW | 51 |
| 240 V | P | kW | 54 |
| 380 V 400 V | P | kW | 90 |
| 415 V | P | kW | 96 |
| 440 V | P | kW | 102 |
| 500 V | P | kW | 116 |
| 660 V 690 V | P | kW | 110 |
| 1000 V | P | kW | 77 |

Condensator operation

| | | | |
|---|------------|-------------------|-----|
| Individual compensation, rated operational current I _e of three-phase capacitors | | | |
| Open | | | |
| up to 525 V | | A | 220 |
| 690 V | | A | 133 |
| Max. inrush current peak | | x I _e | 30 |
| Component lifespan | Operations | x 10 ⁶ | 0.1 |
| Max. operating frequency | | Ops/h | 200 |

DC

| | | | |
|---------------------------------|----------------|---|-----|
| Rated operational current, open | | | |
| DC-1 | | | |
| 60 V | I _e | A | 300 |
| 110 V | I _e | A | 300 |
| 220 V | I _e | A | 300 |
| 440 V | I _e | A | 11 |
| DC-3 | | | |
| 60 V | I _e | A | 300 |
| 110 V | I _e | A | 300 |
| 220 V | I _e | A | 300 |
| DC-5 | | | |
| 60 V | I _e | A | 300 |
| 110 V | I _e | A | 300 |
| 220 V | I _e | A | 300 |

Current heat loss

| | | | |
|---|--|---|----|
| 3-pole at I _{th} | | W | 45 |
| Current heat loss at I _e to AC-3/400 V | | W | 23 |

Magnet systems

| | | | |
|-------------------|---------|------------------|--|
| Voltage tolerance | | x U _C | |
| U _C | | | 100 - 120 V 50/60 Hz |
| AC operated | Pick-up | x U _C | 0.8 x U _{C min} - 1.15 x U _{C max} |

| | | | |
|--|----------|------------------|--|
| AC operated | Drop-out | x U _c | 0.25 x U _{c min} - 0.6 x U _{c max} |
| Power consumption of the coil in a cold state and 1.0 x U _c | | | |
| Pull-in power | Pick-up | VA | 210 |
| Pull-in power | Pick-up | W | 180 |
| Sealing power | Sealing | VA | 2.6 |
| Sealing power | Sealing | W | 2.1 |
| Duty factor | | % DF | 100 |
| Switching times at 100 % U _c (approximate values) | | | |
| Main contacts | | | |
| Closing delay | | ms | 60 |
| Opening delay | | ms | 40 |
| PLC signal level (A3 - A4) to IEC/EN 61131-2 (type 2) | | | |
| High | | V | 15 |
| Low | | V | 5 |

Electromagnetic compatibility (EMC)

| | | |
|-------------------------------|--|--|
| Electromagnetic compatibility | | This product is designed for operation in industrial environments (environment 2). The use in residential environments (environment 1) could cause electrical interference so that addition suppression must be planned. |
|-------------------------------|--|--|

Design verification as per IEC/EN 61439

| | | | |
|--|-------------------|----|--|
| Technical data for design verification | | | |
| Rated operational current for specified heat dissipation | I _n | A | 225 |
| Heat dissipation per pole, current-dependent | P _{vid} | W | 7.67 |
| Equipment heat dissipation, current-dependent | P _{vid} | W | 0 |
| Static heat dissipation, non-current-dependent | P _{vs} | W | 2.1 |
| Heat dissipation capacity | P _{diss} | W | 0 |
| Operating ambient temperature min. | | °C | -40 |
| Operating ambient temperature max. | | °C | 60 |
| IEC/EN 61439 design verification | | | |
| 10.2 Strength of materials and parts | | | |
| 10.2.2 Corrosion resistance | | | Meets the product standard's requirements. |
| 10.2.3.1 Verification of thermal stability of enclosures | | | Meets the product standard's requirements. |
| 10.2.3.2 Verification of resistance of insulating materials to normal heat | | | Meets the product standard's requirements. |
| 10.2.3.3 Verification of resistance of insulating materials to abnormal heat and fire due to internal electric effects | | | Meets the product standard's requirements. |
| 10.2.4 Resistance to ultra-violet (UV) radiation | | | Meets the product standard's requirements. |
| 10.2.5 Lifting | | | Does not apply, since the entire switchgear needs to be evaluated. |
| 10.2.6 Mechanical impact | | | Does not apply, since the entire switchgear needs to be evaluated. |
| 10.2.7 Inscriptions | | | Meets the product standard's requirements. |
| 10.3 Degree of protection of ASSEMBLIES | | | Does not apply, since the entire switchgear needs to be evaluated. |
| 10.4 Clearances and creepage distances | | | Meets the product standard's requirements. |
| 10.5 Protection against electric shock | | | Does not apply, since the entire switchgear needs to be evaluated. |
| 10.6 Incorporation of switching devices and components | | | Does not apply, since the entire switchgear needs to be evaluated. |
| 10.7 Internal electrical circuits and connections | | | Is the panel builder's responsibility. |
| 10.8 Connections for external conductors | | | Is the panel builder's responsibility. |
| 10.9 Insulation properties | | | |
| 10.9.2 Power-frequency electric strength | | | Is the panel builder's responsibility. |
| 10.9.3 Impulse withstand voltage | | | Is the panel builder's responsibility. |
| 10.9.4 Testing of enclosures made of insulating material | | | Is the panel builder's responsibility. |
| 10.10 Temperature rise | | | The panel builder is responsible for the temperature rise calculation. Eaton will provide heat dissipation data for the devices. |
| 10.11 Short-circuit rating | | | Is the panel builder's responsibility. The specifications for the switchgear must be observed. |
| 10.12 Electromagnetic compatibility | | | Is the panel builder's responsibility. The specifications for the switchgear must be observed. |
| 10.13 Mechanical function | | | The device meets the requirements, provided the information in the instruction leaflet (IL) is observed. |

Technical data ETIM 5.0

| | | |
|--|----|-----------------|
| Low-voltage industrial components (EG000017) / Magnet contactor, AC-switching (EC000066) | | |
| Electric engineering, automation, process control engineering / Low-voltage switch technology / Contactor (LV) / Power contactor, AC switching (ecl@ss8-27-37-10-03 [AAB718011]) | | |
| Rated control supply voltage Us at AC 50HZ | V | 100 - 120 |
| Rated control supply voltage Us at AC 60HZ | V | 100 - 120 |
| Rated control supply voltage Us at DC | V | 0 - 0 |
| Voltage type for actuating | | AC |
| Rated operation current Ie at AC-1, 400 V | A | 356 |
| Rated operation current Ie at AC-3, 400 V | A | 225 |
| Rated operation power at AC-3, 400 V | kW | 110 |
| Rated operation current Ie at AC-4, 400 V | A | 164 |
| Rated operation power Ie at AC-4, 400 V | kW | 90 |
| Modular version | | No |
| Number of auxiliary contacts as normally open contact | | 2 |
| Number of auxiliary contacts as normally closed contact | | 2 |
| Connection type main current circuit | | Rail connection |
| Number of normally closed contacts as main contact | | 0 |
| Number of main contacts as normally open contact | | 3 |

Approvals

| | | |
|--------------------------------------|--|--|
| Product Standards | | IEC/EN 60947-4-1; UL508;CSA-C22.2 No.14-05; CE marking |
| UL File No. | | E29096 |
| UL Category Control No. | | NLDX |
| CSA File No. | | 2389068 |
| CSA Class No. | | 3211-04 |
| North America Certification | | UL listed, CSA certified |
| Specially designed for North America | | No |

Characteristics

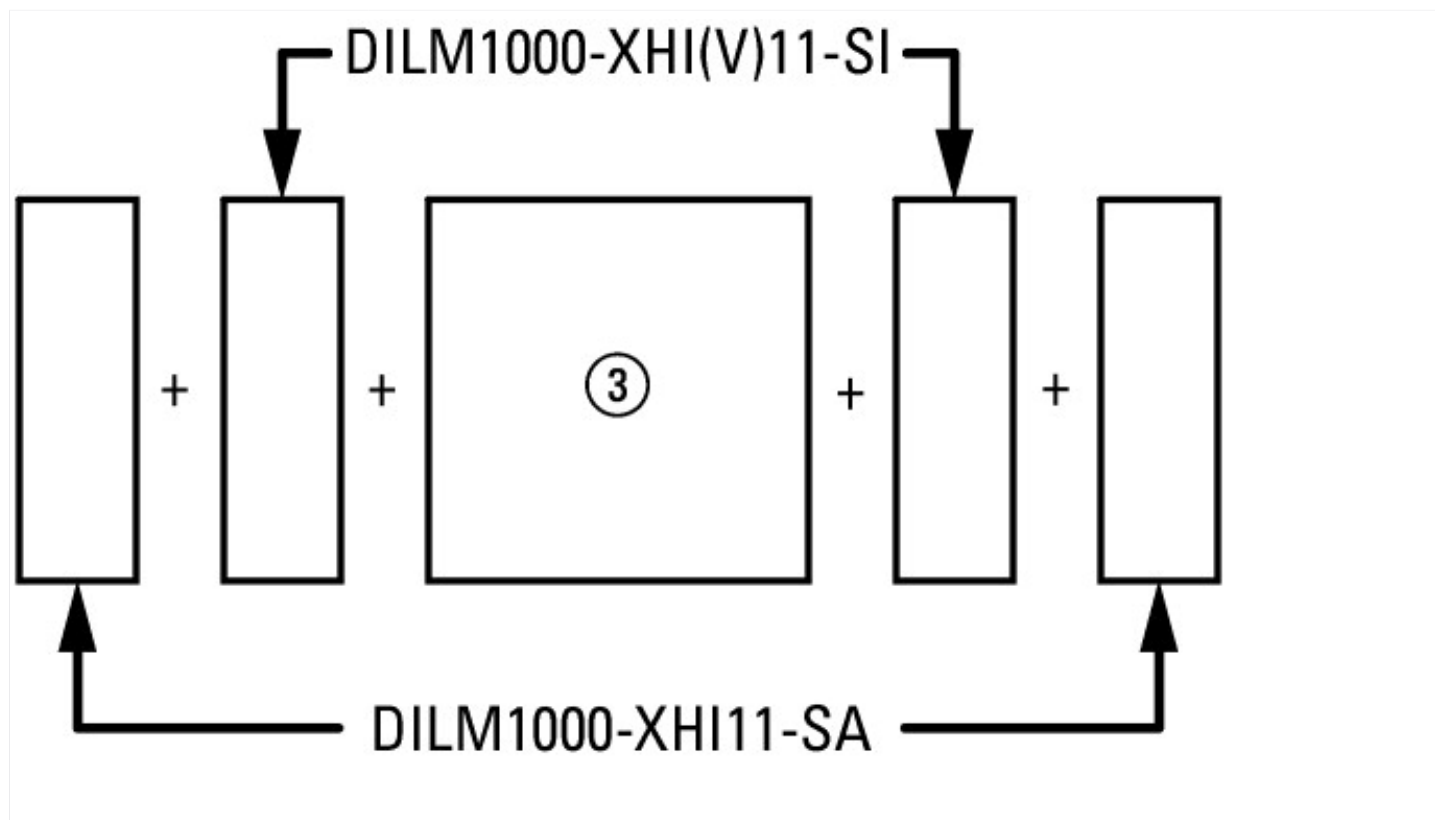

on the side: 2 x DILM1000-XHI(V)11-SI; 2 x DILM1000-XHI11-SA

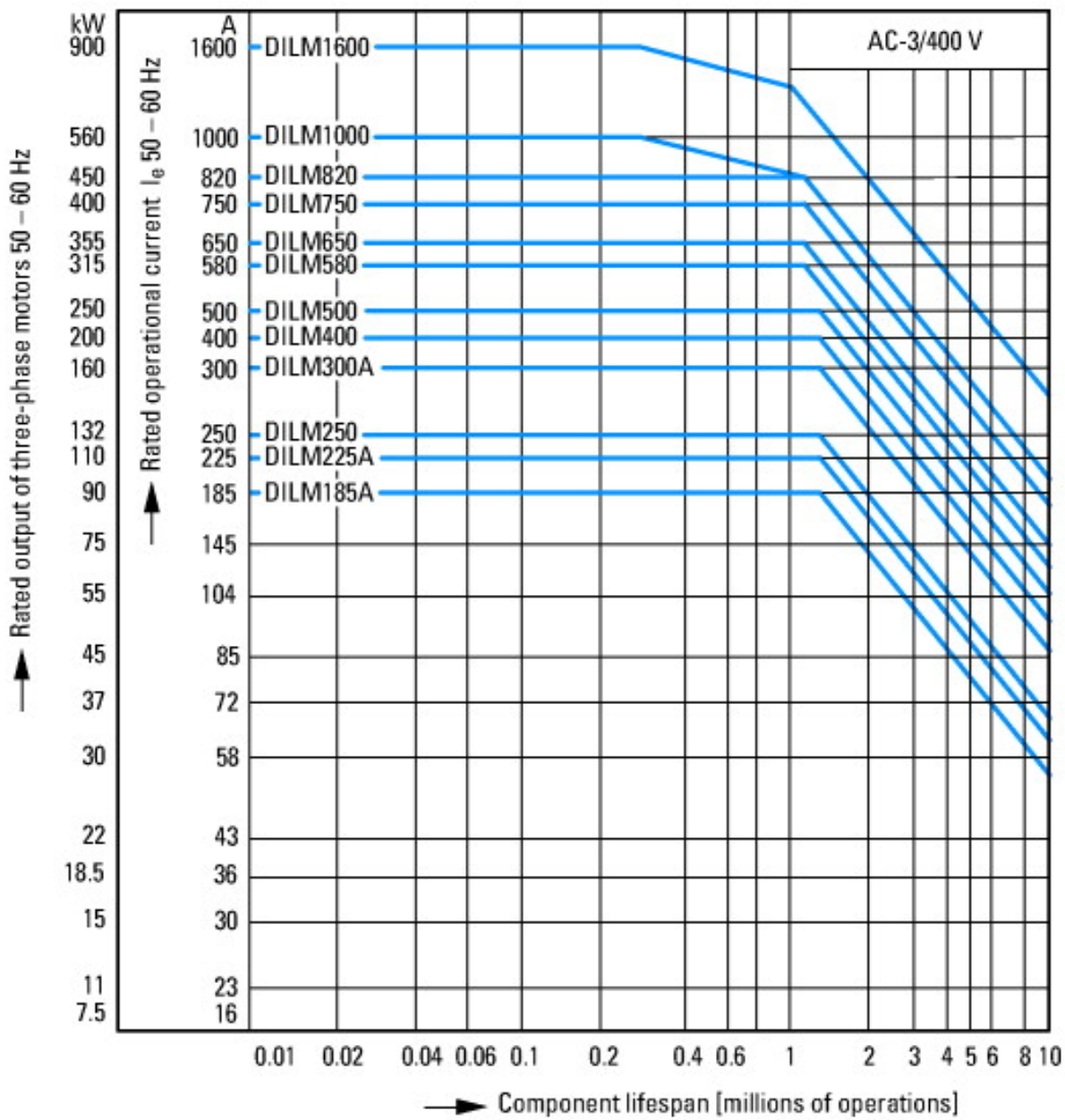

Normal switching duty
 Normal AC induction motor
 Operating characteristics
 Switch on: from stop
 Switch off: during run
 Electrical characteristics:
 Switch on: up to 6 x Rated motor current
 Switch off: up to 1 x Rated motor current
 Utility category
 100 % AC-3
 Typical Applications
 Compressors
 Lifts
 Mixers
 Pumps
 Escalators
 Agitators
 fan
 Conveyor belts
 Centrifuges
 Hinged flaps
 Bucket-elevator
 Air-conditioning systems
 General drives for manufacturing and processing machines

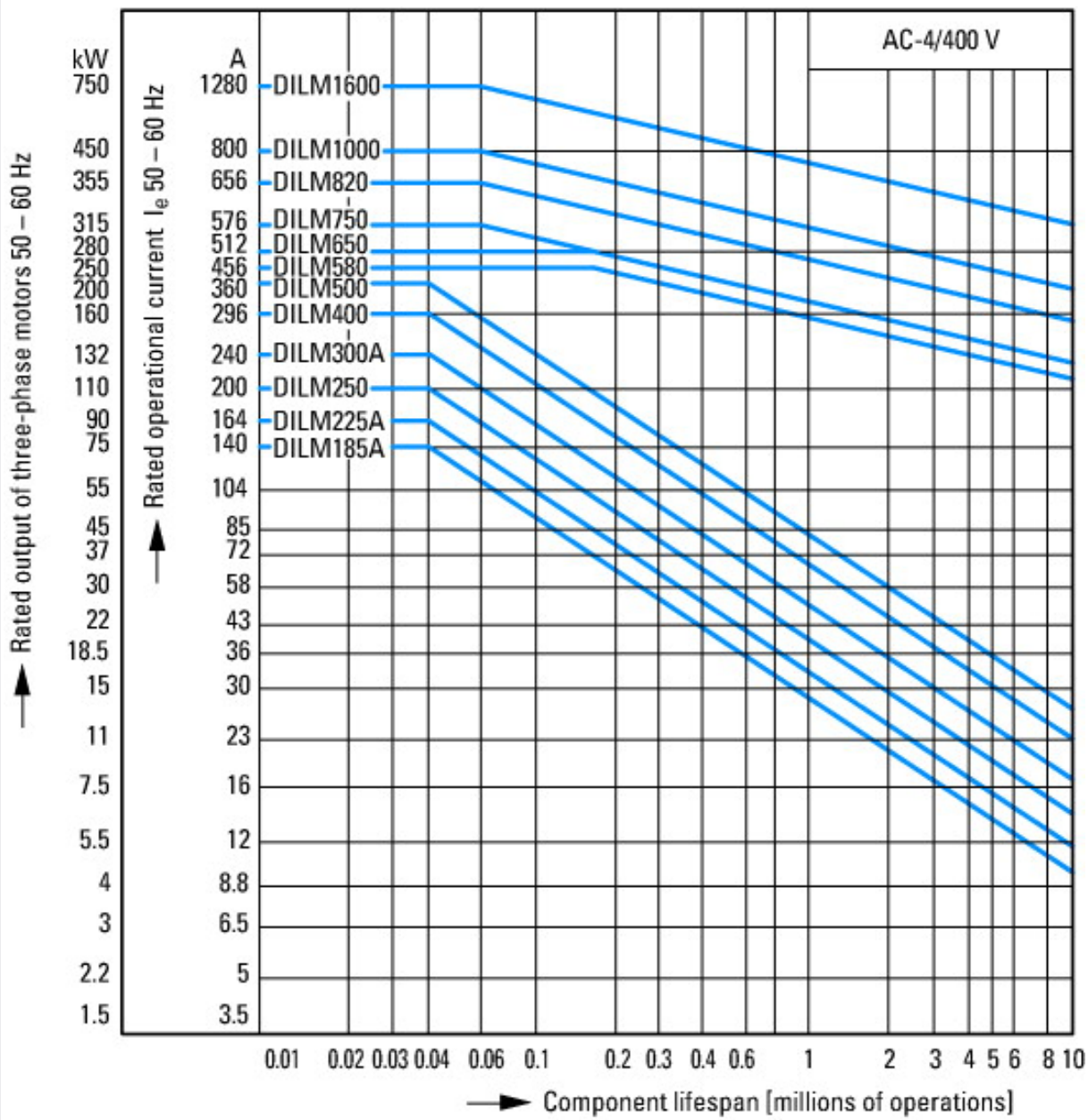

Extreme switching duty
 Squirrel-cage motor
 Operating characteristics
 Inching, plugging, reversing
 Electrical characteristics
 Make: up to 6 x rated motor current
 Break: up to 6 x rated motor current
 Utilization category
 100 % AC-4
 Typical applications
 Printing presses
 Wire-drawing machines
 Centrifuges
 Special drives for manufacturing and processing machines

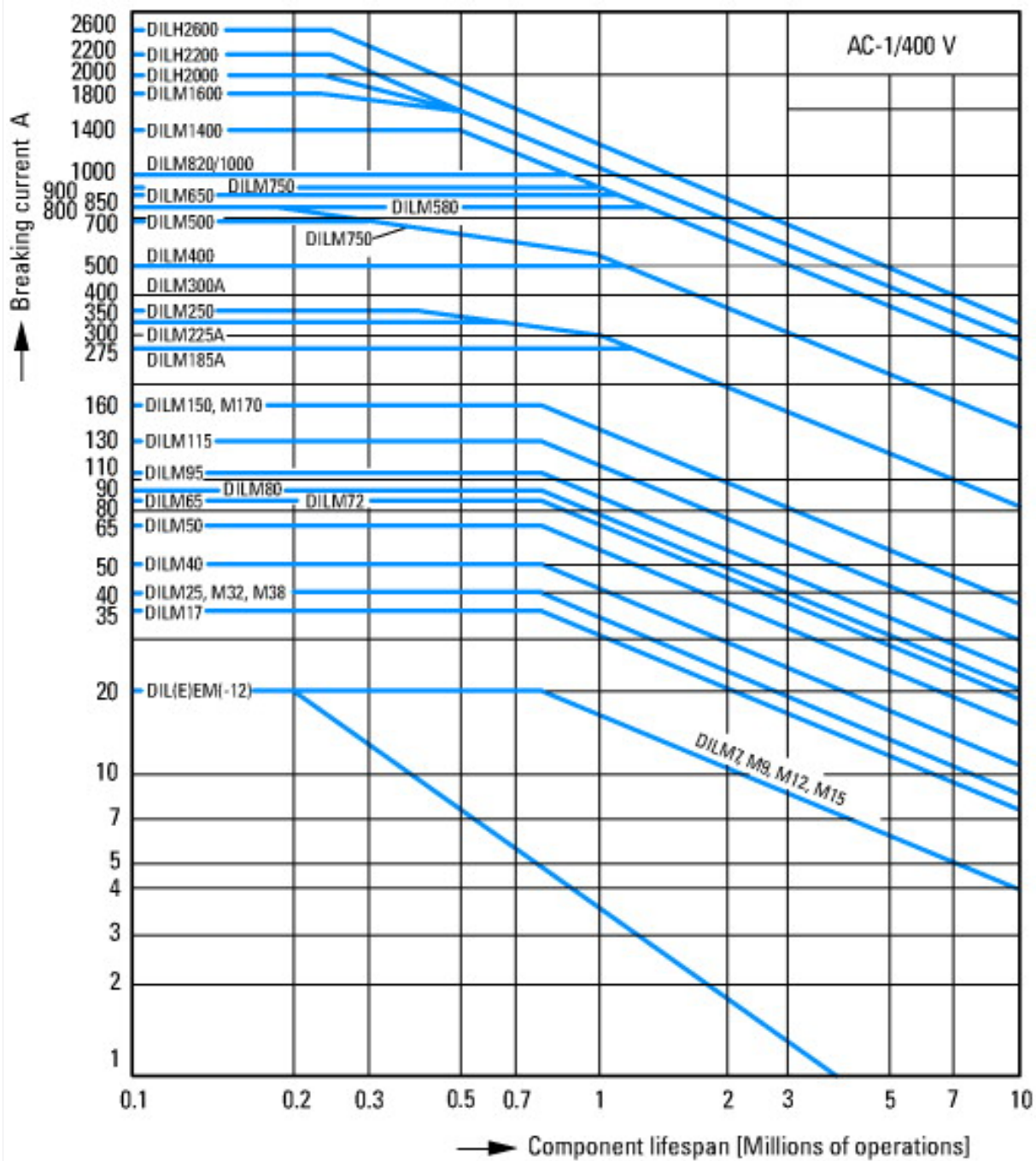

Switching duty for non-motor loads, 3-pole, 4-pole
 Operating characteristics
 Non-inductive or slightly inductive loads
 Electrical characteristics
 Make: 1 x rated current
 Break: 1 x rated current
 Utilization category
 100 % AC-1
 Typical applications
 Electric heat

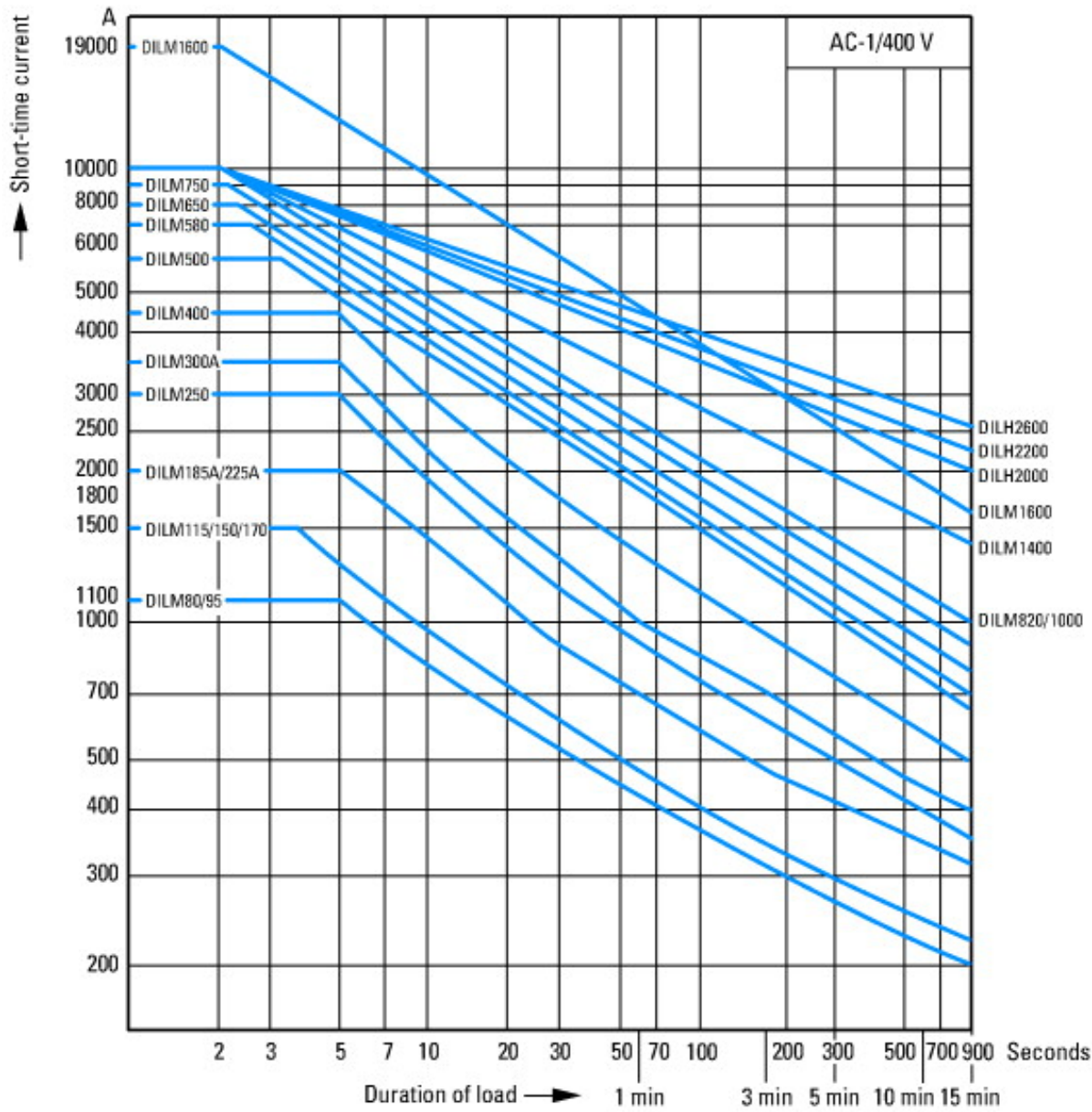

Short-time loading, 3-pole
Time interval between two loading cycles: 15 minutes

Dimensions

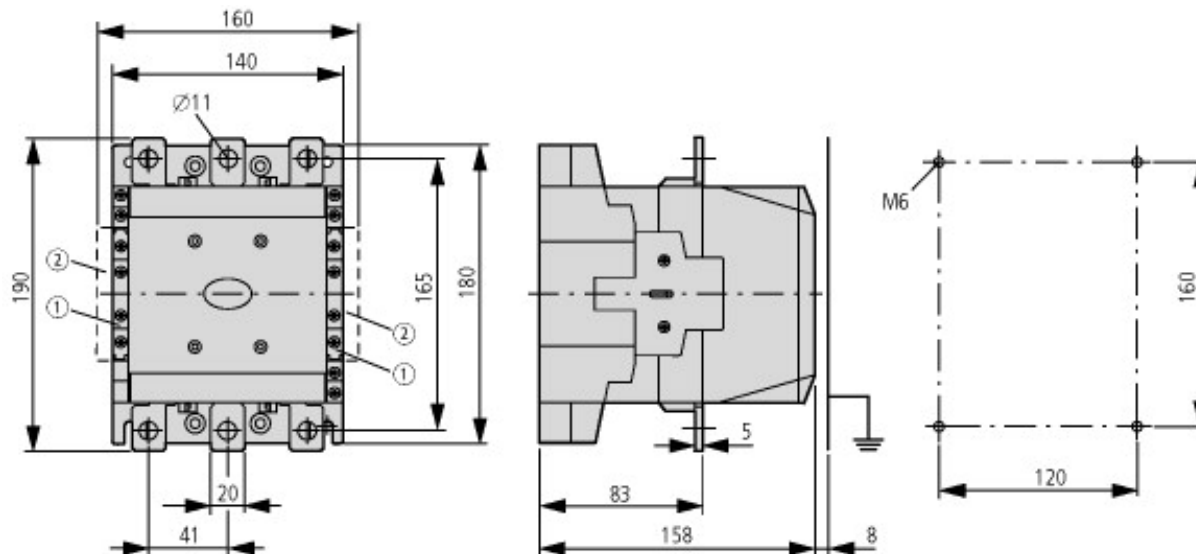

- ① DILM1000-XHI(V)11-SI
- ② DILM1000-XHI11-SA

Additional product information (links)

| IL03406001Z Contactors | |
|--|---|
| IL03406001Z Contactors | ftp://ftp.moeller.net/DOCUMENTATION/AWA_INSTRUCTIONS/IL03406001Z2010_06.pdf |
| Switchgear of Power Factor Correction Systems | http://www.moeller.net/binary/ver_techpapers/ver934en.pdf |
| X-Start - Modern Switching Installations Efficiently Fitted and Wired Securely | http://www.moeller.net/binary/ver_techpapers/ver938en.pdf |
| Mirror Contacts for Highly-Reliable Information Relating to Safety-Related Control Functions | http://www.moeller.net/binary/ver_techpapers/ver944en.pdf |
| Effect of the Cable Capacitance of Long Control Cables on the Actuation of Contactors | http://www.moeller.net/binary/ver_techpapers/ver949en.pdf |
| Motor starters and "Special Purpose Ratings" for the North American market | http://www.moeller.net/binary/ver_techpapers/ver953en.pdf |
| Switchgear for Luminaires | http://www.moeller.net/binary/ver_techpapers/ver955en.pdf |
| Standard Compliant and Functionally Safe Engineering Design with Mechanical Auxiliary Contacts | http://www.moeller.net/binary/ver_techpapers/ver956en.pdf |
| The Interaction of Contactors with PLCs | http://www.moeller.net/binary/ver_techpapers/ver957en.pdf |
| Busbar Component Adapters for modern Industrial control panels | http://www.moeller.net/binary/ver_techpapers/ver960en.pdf |