

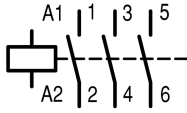

Contactor, 3p, 22kW/400V/AC3

Part no. DILM50(RDC60)
Article no. 277845
Catalog No. XTCE050D00WD

Delivery programme

Product range			Contactors
Application			Contactors for Motors
Subrange			Contactors up to 170 A, 3 pole
Utilization category			AC-1: Non-inductive or slightly inductive loads, resistance furnaces NAC-3: Normal AC induction motors: starting, switch off during running AC-4: Normal AC induction motors: starting, plugging, reversing, inching
			
Notes			Also suitable for motors with efficiency class IE3. IE3-ready devices are identified by the logo on their packaging.
Connection technique			Screw terminals
Pole			3 pole
Rated operational current			
AC-3			
380 V 400 V	I_e	A	50
AC-1			
Conventional free air thermal current, 3 pole, 50 - 60 Hz			
Open			
at 40 °C	$I_{th} = I_e$	A	80
enclosed	I_{th}	A	58
Conventional free air thermal current, 1 pole			
open	I_{th}	A	162
enclosed	I_{th}	A	145
Max. rating for three-phase motors, 50 - 60 Hz			
AC-3			
220 V 230 V	P	kW	15.5
380 V 400 V	P	kW	22
660 V 690 V	P	kW	30
AC-4			
220 V 230 V	P	kW	6
380 V 400 V	P	kW	10
660 V 690 V	P	kW	14
Contact sequence			
Instructions			Contacts to EN 50012. integrated suppressor circuit in actuating electronics
Can be combined with auxiliary contact			DILM150-XHI(V).. DILM1000-XHI(V)..
Voltage AC/DC			DC operation

Technical data

General			
Standards			IEC/EN 60947, VDE 0660, UL, CSA
Lifespan, mechanical			

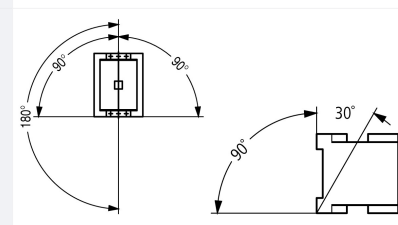
AC operated	Operations	x 10 ⁶	10
DC operated	Operations	x 10 ⁶	10
Operating frequency, mechanical			
AC operated	Operations/h		5000
DC operated	Operations/h		5000
Climatic proofing			
Damp heat, constant, to IEC 60068-2-78 Damp heat, cyclic, to IEC 60068-2-30			
Ambient temperature		°C	
Open		°C	-25 - +60
Enclosed		°C	-25 - 40
Storage		°C	-40 - 80
Mounting position			
Mechanical shock resistance (IEC/EN 60068-2-27)			
Half-sinusoidal shock, 10 ms			
Main contacts			
N/O contact		g	10
Auxiliary contacts			
N/O contact		g	7
N/C contact		g	5
Mechanical shock resistance (IEC/EN 60068-2-27) when tabletop-mounted			
Half-sinusoidal shock, 10 ms			
Main contacts			
N/O contact		g	10
Auxiliary contacts			
N/O contact		g	7
N/C contact		g	5
Degree of Protection			
Protection against direct contact when actuated from front (EN 50274)			IP00
Finger and back-of-hand proof			
Weight			
AC operated		kg	0.9
DC operated		kg	1.1
Terminal capacity main cable			
Solid		mm ²	1 x (0.75 - 16) 2 x (0.75 - 16)
Flexible with ferrule		mm ²	1 x (0.75 - 35) 2 x (0.75 - 25)
Stranded		mm ²	1 x (16 - 50) 2 x (16 - 35)
Solid or stranded		AWG	12 - 2
Flat conductor	Lamellenzahl x Breite x Dicke	mm	2 x (6 x 9 x 0.8)
Main cable connection screw/bolt			
Tightening torque			M6
Tightening torque			Nm 3.3
Terminal capacity control circuit cables			
Solid		mm ²	1 x (0.75 - 4) 2 x (0.75 - 4)
Flexible with ferrule		mm ²	1 x (0.75 - 2.5) 2 x (0.75 - 2.5)
Solid or stranded		AWG	18 - 14
Control circuit cable connection screw/bolt			
Tightening torque			M3.5
Tightening torque			Nm 1.2
Tool			

Main cable			
Pozidriv screwdriver		Size	2
Standard screwdriver		mm	0.8 x 5.5 1 x 6
Control circuit cables			
Pozidriv screwdriver		Size	2
Standard screwdriver		mm	0.8 x 5.5 1 x 6
Terminal capacity control circuit cables			
Solid		mm ²	1 x (0.75 - 2.5) 2 x (0.75 - 2.5)
Flexible		mm ²	1 x (0.75 - 2.5) 2 x (0.75 - 2.5)
Flexible with ferrule		mm ²	1 x (0.75 - 1.5) 2 x (0.75 - 1.5)
Solid or stranded		AWG	18 - 14
Tool			
Stripping length		mm	10
Screwdriver blade width		mm	3.5

Main conducting paths

Rated impulse withstand voltage	U_{imp}	V AC	8000
Overvoltage category/pollution degree			III/3
Rated insulation voltage	U_i	V AC	690
Rated operational voltage	U_e	V AC	690
Safe isolation to EN 61140			
between coil and contacts		V AC	440
between the contacts		V AC	440
Making capacity (p.f. to IEC/EN 60947)			
	U_p to 690 V	A	700
Breaking capacity			
220 V 230 V		A	500
380 V 400 V		A	500
500 V		A	500
660 V 690 V		A	320
Short-circuit rating			
Short-circuit protection maximum fuse			
Type "2" coordination			
400 V	gG/gL 500 V	A	80
690 V	gG/gL 690 V	A	63
Type "1" coordination			
400 V	gG/gL 500 V	A	160
690 V	gG/gL 690 V	A	80

AC

AC-1			
Rated operational current			
Conventional free air thermal current, 3 pole, 50 - 60 Hz			
Open			
at 40 °C	$I_{th} = I_e$	A	80
at 50 °C	$I_{th} = I_e$	A	71
at 55 °C	$I_{th} = I_e$	A	68
at 60 °C	$I_{th} = I_e$	A	65
enclosed	I_{th}	A	58
Conventional free air thermal current, 1 pole			
open	I_{th}	A	162
enclosed	I_{th}	A	145
AC-3			
Rated operational current			

Open, 3-pole: 50 – 60 Hz			
220 V 230 V	I_e	A	50
240 V	I_e	A	50
380 V 400 V	I_e	A	50
415 V	I_e	A	50
440V	I_e	A	50
500 V	I_e	A	50
660 V 690 V	I_e	A	32
380 V 400 V	I_e	A	50
Motor rating	P	kWh	
220 V 230 V	P	kW	15.5
240V	P	kW	17
380 V 400 V	P	kW	22
415 V	P	kW	30
440 V	P	kW	32
500 V	P	kW	36
660 V 690 V	P	kW	30
AC-4			
Open, 3-pole: 50 – 60 Hz			
220 V 230 V	I_e	A	21
240 V	I_e	A	21
380 V 400 V	I_e	A	21
415 V	I_e	A	21
440 V	I_e	A	21
500 V	I_e	A	21
660 V 690 V	I_e	A	17
Motor rating	P	kWh	
220 V 230 V	P	kW	6
240 V	P	kW	6.5
380 V 400 V	P	kW	10
415 V	P	kW	11
440 V	P	kW	12
500 V	P	kW	13
660 V 690 V	P	kW	14
DC			
Rated operational current, open			
DC-1			
60 V	I_e	A	60
110 V	I_e	A	50
220 V	I_e	A	45
440 V	I_e	A	2.9
DC-3			
60 V	I_e	A	60
110 V	I_e	A	50
220 V	I_e	A	25
440 V	I_e	A	0.6
DC-5			
60 V	I_e	A	60
110 V	I_e	A	50
220 V	I_e	A	25
440 V	I_e	A	0.6
Current heat loss			
3-pole at I_{th}		W	19

Current heat loss at I_g to AC-3/400 V	W	11.3
Impedance per pole	m Ω	1.5

Magnet systems

Voltage tolerance		$\times U_c$	
AC operated	Pick-up	$\times U_c$	0.8 - 1.1
Drop-out voltage AC operated	Drop-out	$\times U_c$	0.3 - 0.6
DC operated	Pick-up	$\times U_c$	0.7 - 1.2
Notes			RDC 60 (U_{min} 48 V DC/ U_{max} 60 V DC) Example: $U_c = 0.7 \times U_{min} - 1.2 \times U_{max} / U_c = 0.7 \times 48 V - 1.2 \times 60 V DC$
DC operated	Drop-out	$\times U_c$	0.15 - 0.6
Notes			at least smoothed two-phase bridge rectifier or three-phase rectifier
Power consumption of the coil in a cold state and $1.0 \times U_c$			
50 Hz	Pick-up	VA	149
50 Hz	Sealing	VA	16
50 Hz	Sealing	W	4.3
60 Hz	Pick-up	VA	178
60 Hz	Sealing	VA	19
60 Hz	Sealing	W	5.3
50/60 Hz	Pick-up	VA	168 154
50/60 Hz	Sealing	VA	22 14
50/60 Hz	Sealing	W	5.3 4.3
DC operated	Pick-up	W	24
DC operated	Sealing	W	0.5
Duty factor		% DF	100
Switching times at 100 % U_c (approximate values)			
Main contacts			
AC operated			
Closing delay		ms	12 - 18
Opening delay		ms	8 - 13
DC operated		ms	
Closing delay		ms	54
Opening delay		ms	24
Arcing time		ms	10
Lifespan, mechanical; Coil 50/60 Hz		$\times 10^6$	Mechanical lifespan at 50 Hz approx. 30% lower than under "Technical data, general"

Electromagnetic compatibility (EMC)

Emitted interference			to EN 60947-1
Interference immunity			to EN 60947-1

Design verification as per IEC/EN 61439

Technical data for design verification			
Rated operational current for specified heat dissipation	I_n	A	50
Heat dissipation per pole, current-dependent	P_{vid}	W	3.3
Equipment heat dissipation, current-dependent	P_{vid}	W	9.9
Static heat dissipation, non-current-dependent	P_{vs}	W	1
Heat dissipation capacity	P_{diss}	W	0
Operating ambient temperature min.		°C	-25
Operating ambient temperature max.		°C	60
IEC/EN 61439 design verification			
10.2 Strength of materials and parts			
10.2.2 Corrosion resistance			Meets the product standard's requirements.
10.2.3.1 Verification of thermal stability of enclosures			Meets the product standard's requirements.
10.2.3.2 Verification of resistance of insulating materials to normal heat			Meets the product standard's requirements.

10.2.3.3 Verification of resistance of insulating materials to abnormal heat and fire due to internal electric effects		Meets the product standard's requirements.
10.2.4 Resistance to ultra-violet (UV) radiation		Meets the product standard's requirements.
10.2.5 Lifting		Does not apply, since the entire switchgear needs to be evaluated.
10.2.6 Mechanical impact		Does not apply, since the entire switchgear needs to be evaluated.
10.2.7 Inscriptions		Meets the product standard's requirements.
10.3 Degree of protection of ASSEMBLIES		Does not apply, since the entire switchgear needs to be evaluated.
10.4 Clearances and creepage distances		Meets the product standard's requirements.
10.5 Protection against electric shock		Does not apply, since the entire switchgear needs to be evaluated.
10.6 Incorporation of switching devices and components		Does not apply, since the entire switchgear needs to be evaluated.
10.7 Internal electrical circuits and connections		Is the panel builder's responsibility.
10.8 Connections for external conductors		Is the panel builder's responsibility.
10.9 Insulation properties		
10.9.2 Power-frequency electric strength		Is the panel builder's responsibility.
10.9.3 Impulse withstand voltage		Is the panel builder's responsibility.
10.9.4 Testing of enclosures made of insulating material		Is the panel builder's responsibility.
10.10 Temperature rise		The panel builder is responsible for the temperature rise calculation. Eaton will provide heat dissipation data for the devices.
10.11 Short-circuit rating		Is the panel builder's responsibility. The specifications for the switchgear must be observed.
10.12 Electromagnetic compatibility		Is the panel builder's responsibility. The specifications for the switchgear must be observed.
10.13 Mechanical function		The device meets the requirements, provided the information in the instruction leaflet (IL) is observed.

Technical data ETIM 5.0

Low-voltage industrial components (EG000017) / Magnet contactor, AC-switching (EC000066)		
Electric engineering, automation, process control engineering / Low-voltage switch technology / Contactor (LV) / Power contactor, AC switching (ecl@ss8-27-37-10-03 [AAB718011])		
Rated control supply voltage Us at AC 50HZ	V	0 - 0
Rated control supply voltage Us at AC 60HZ	V	0 - 0
Rated control supply voltage Us at DC	V	48 - 60
Voltage type for actuating		DC
Rated operation current Ie at AC-1, 400 V	A	80
Rated operation current Ie at AC-3, 400 V	A	50
Rated operation power at AC-3, 400 V	kW	22
Rated operation current Ie at AC-4, 400 V	A	21
Rated operation power Ie at AC-4, 400 V	kW	10
Modular version		No
Number of auxiliary contacts as normally open contact		0
Number of auxiliary contacts as normally closed contact		0
Connection type main current circuit		Screw connection
Number of normally closed contacts as main contact		0
Number of main contacts as normally open contact		3

Approvals

Product Standards		IEC/EN 60947-4-1; UL 508; CSA-C22.2 No. 14-05; CE marking
UL File No.		E29096
UL Category Control No.		NLDX
CSA File No.		012528
CSA Class No.		2411-03, 3211-04
North America Certification		UL listed, CSA certified
Specially designed for North America		No

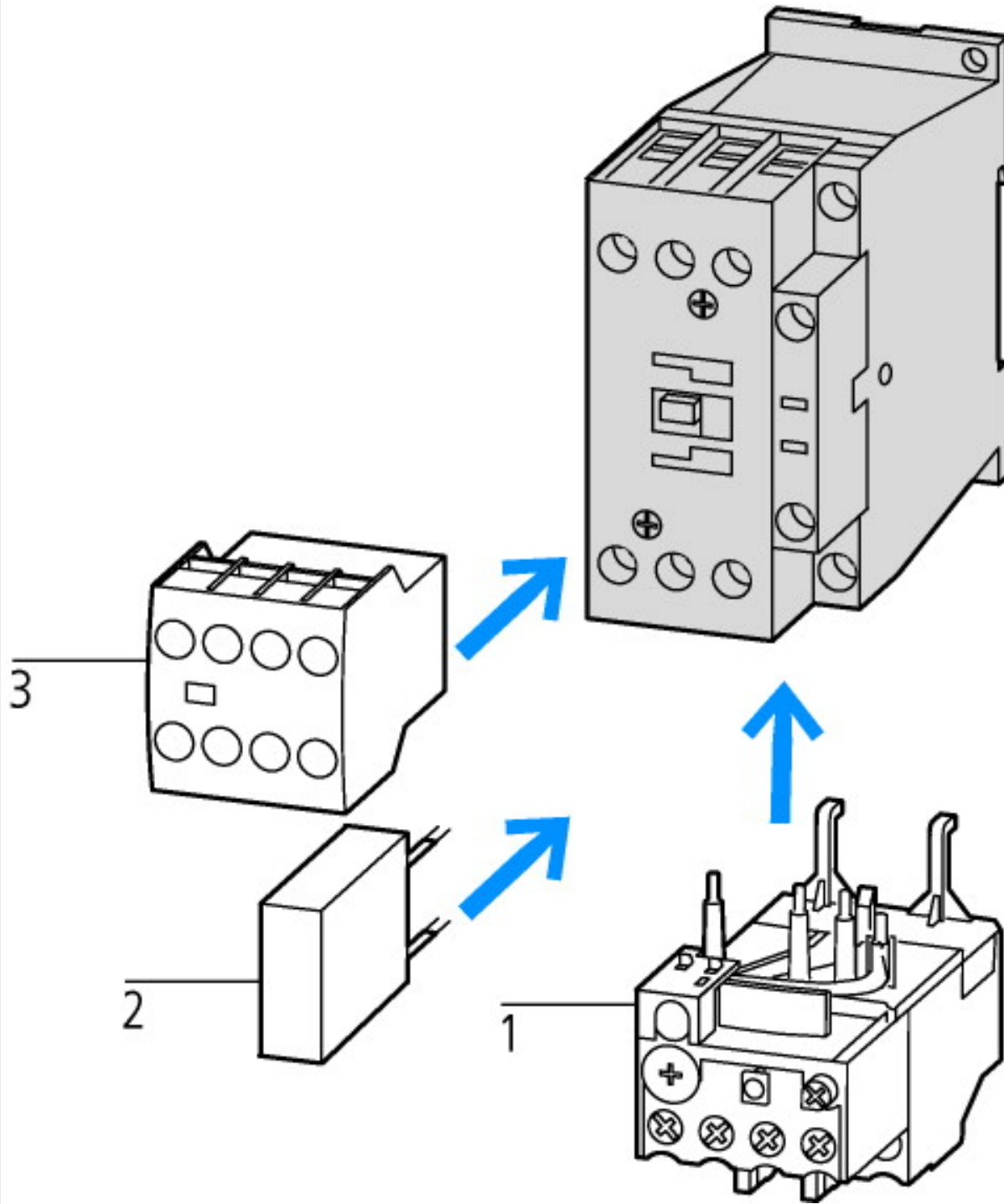

- 1: Overload relay
- 2: Suppressor
- 3: Auxiliary contact modules

DILM1000-XHI(V)11-...

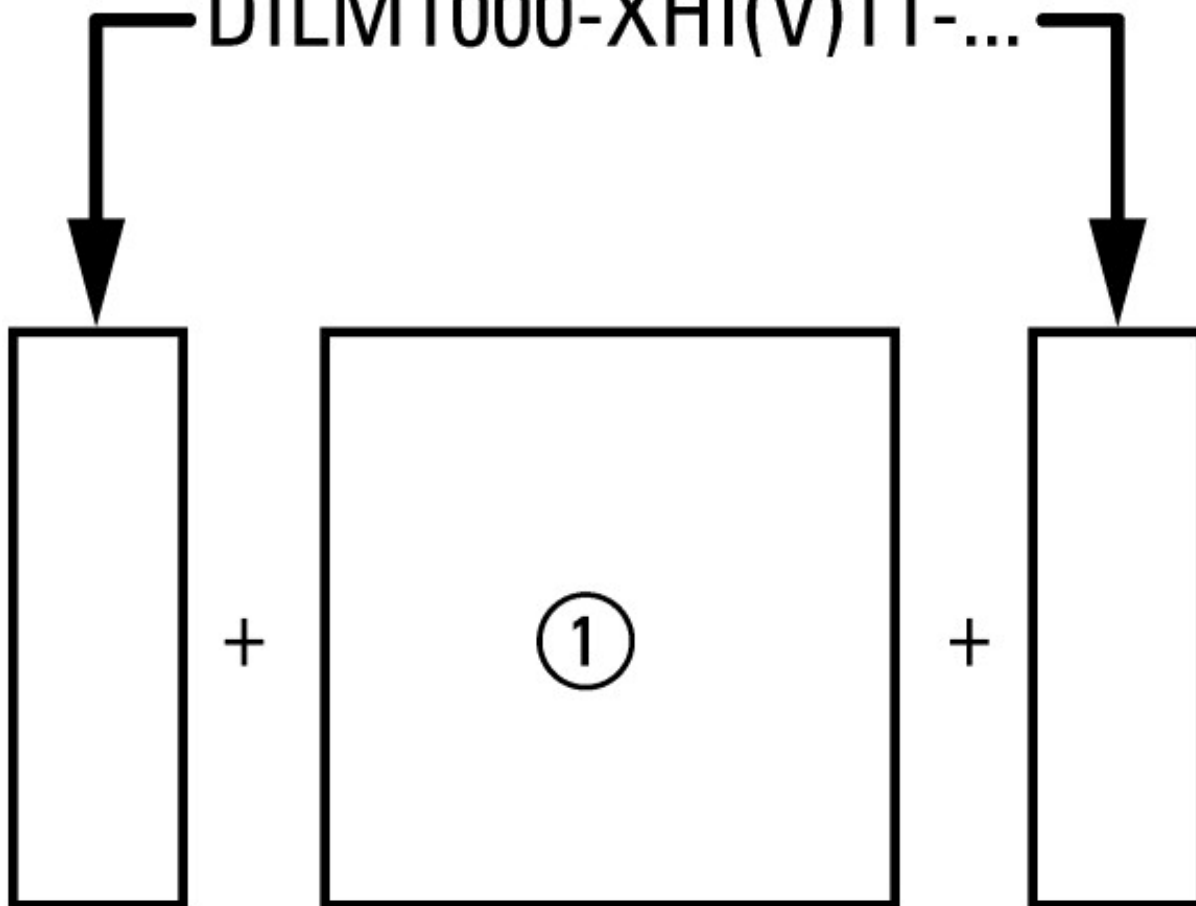

on the side: 2 x DILM1000-XHI(V)11-SI; surface mounting: 1 x DILM150-XHIA11
 on the side: 2 x DILM1000-XHI(V)11-SA; surface mounting: 1 x DILM150-XHI (2 pole)
 on the side: 1 x DILM1000-XHI(V)11-SI; surface mounting: 1 x DILM150-XHIA22
 on the side: 1 x DILM1000-XHI(V)11-SA; surface mounting: 1 x DILM150-XHI (4 pole)

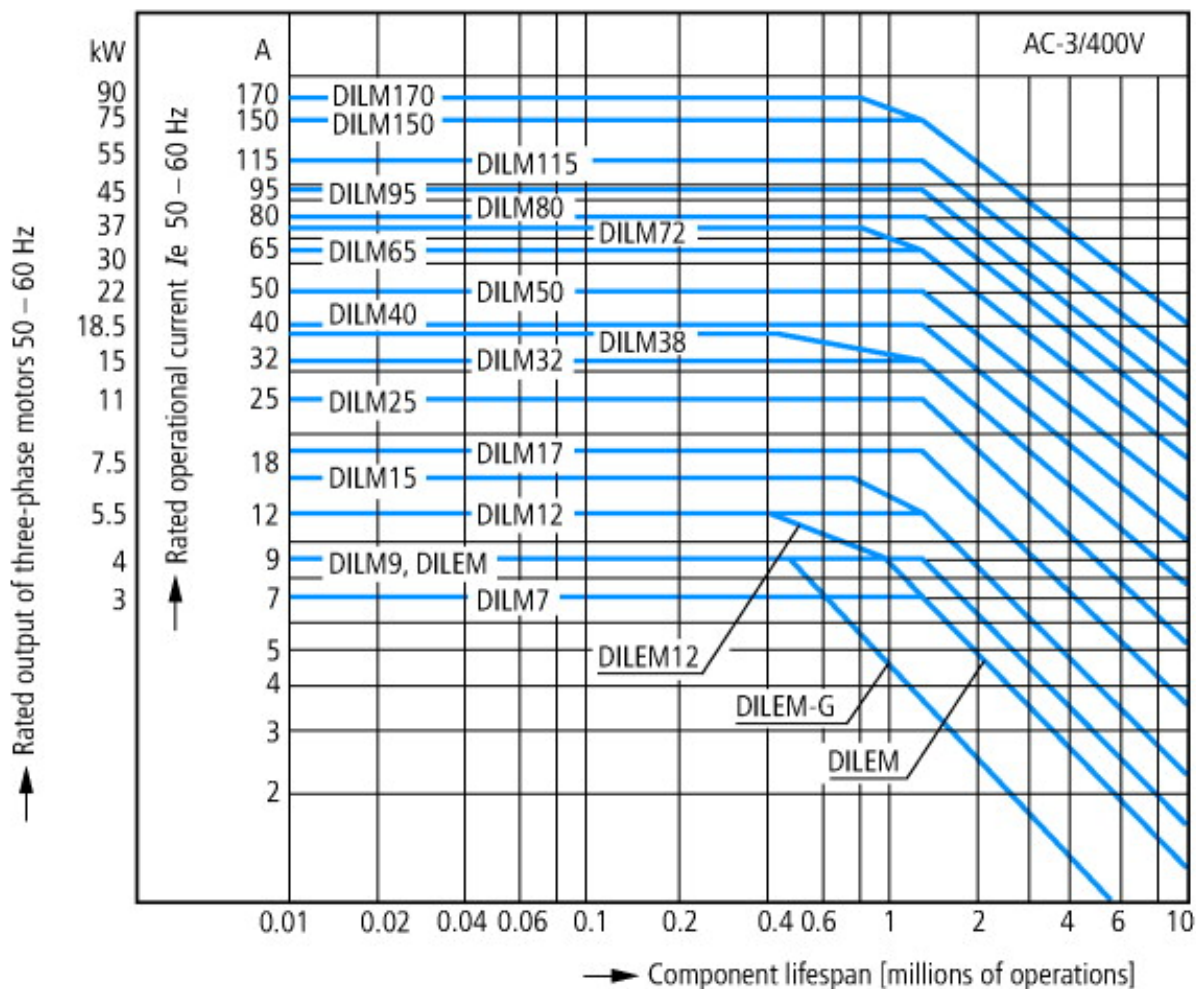

Squirrel-cage motor
 Operating characteristics
 Starting: from rest
 Stopping: after attaining full running speed
 Electrical characteristics
 Make: up to 6 x rated motor current
 Break: up to 1 x rated motor current
 Utilization category
 100 % AC-3
 Typical applications
 Compressors
 Lifts
 Mixers
 Pumps
 Escalators
 Agitators
 Fans
 Conveyor belts
 Centrifuges
 Hinged flaps
 Bucket-elevators
 Air conditioning system
 General drives in manufacturing and processing machines

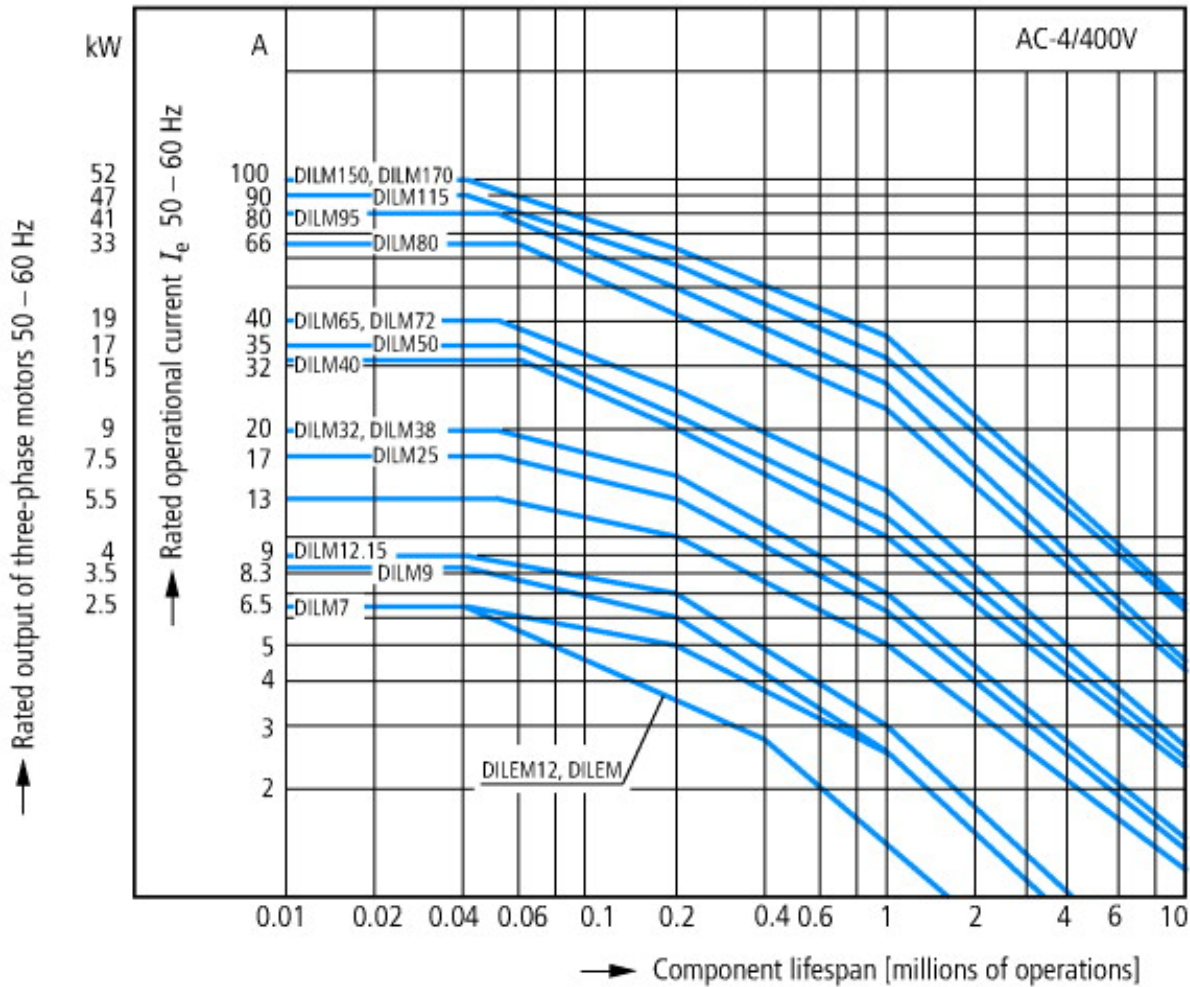

Extreme switching duty
 Squirrel-cage motor
 Operating characteristics
 Inching, plugging, reversing
 Electrical characteristics
 Make: up to 6 x rated motor current
 Break: up to 6 x rated motor current
 Utilization category
 100 % AC-4
 Typical applications
 Printing presses
 Wire-drawing machines
 Centrifuges
 Special drives for manufacturing and processing machines

Dimensions

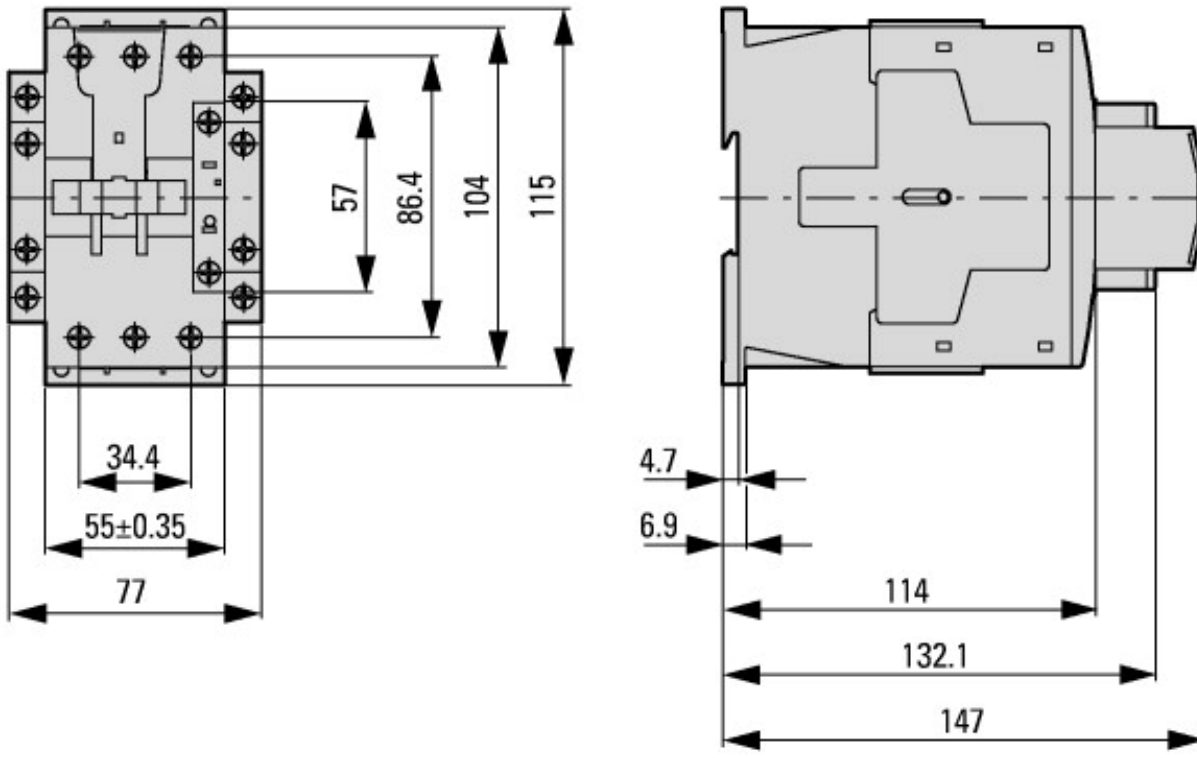

Contacteur with auxiliary contact module

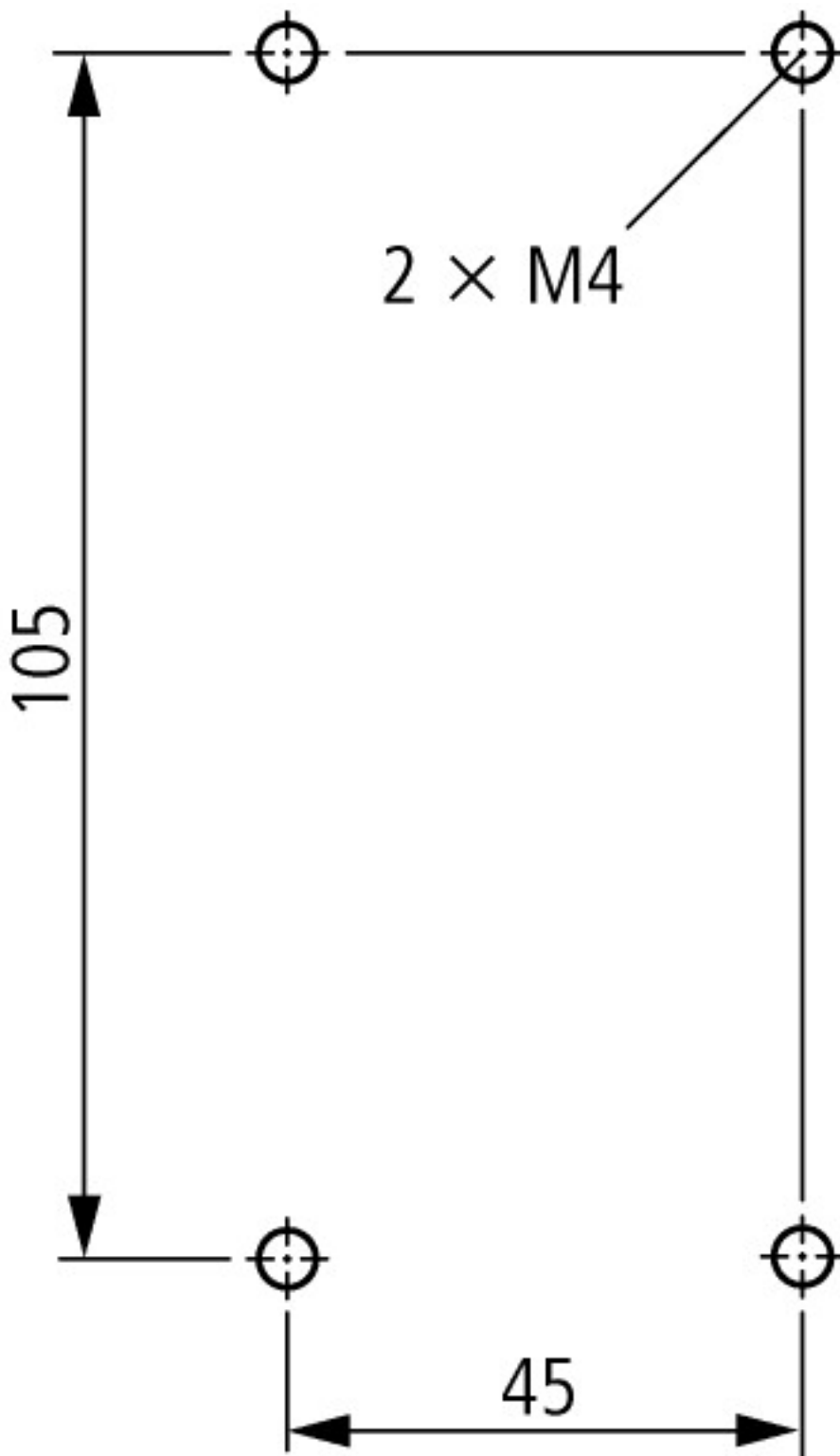

Lateral clearance to earthed parts: 6 mm

DILM40...DILM72
 DILMC40...DILMC65
 DILMF40...DILMF65

Additional product information (links)

IL03407033Z (AWA2100-2247) Contactor DILM, basic unit

IL03407033Z (AWA2100-2247) Contactor DILM, basic unit ftp://ftp.moeller.net/DOCUMENTATION/AWA_INSTRUCTIONS/IL03407033Z2012_03.pdf

UL/CSA: Approved rating data <http://de.ecat.moeller.net/flip-cat/?edition=HPLTE&startpage=5.84>

UL/CSA: UL/CSA: Special Purpose Rating <http://de.ecat.moeller.net/flip-cat/?edition=HPLTE&startpage=5.85>

UL/CSA: UL/CSA: Short Circuit Current Rating (SCCR) <http://de.ecat.moeller.net/flip-cat/?edition=HPLTE&startpage=5.86>

Switchgear of Power Factor Correction Systems http://www.moeller.net/binary/ver_techpapers/ver934en.pdf

X-Start - Modern Switching Installations Efficiently Fitted and Wired Securely http://www.moeller.net/binary/ver_techpapers/ver938en.pdf

Mirror Contacts for Highly-Reliable Information Relating to Safety-Related Control Functions	http://www.moeller.net/binary/ver_techpapers/ver944en.pdf
Effect of the Cable Capacitance of Long Control Cables on the Actuation of Contactors	http://www.moeller.net/binary/ver_techpapers/ver949en.pdf
Motor starters and "Special Purpose Ratings" for the North American market	http://www.moeller.net/binary/ver_techpapers/ver953en.pdf
Switchgear for Luminaires	http://www.moeller.net/binary/ver_techpapers/ver955en.pdf
Standard Compliant and Functionally Safe Engineering Design with Mechanical Auxiliary Contacts	http://www.moeller.net/binary/ver_techpapers/ver956en.pdf
The Interaction of Contactors with PLCs	http://www.moeller.net/binary/ver_techpapers/ver957en.pdf
Busbar Component Adapters for modern Industrial control panels	http://www.moeller.net/binary/ver_techpapers/ver960en.pdf