





**Overload relay, 70-100A, 1N/O+1N/C**

**Part no.** ZB150-100/KK  
**Article no.** 278470  
**Catalog No.** XTOB100GC1S

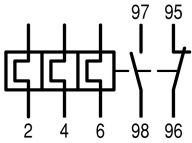

Powering Business Worldwide™

**Delivery programme**

Product range			Overload relay ZB up to 150 A
Frame size			ZB150
Phase-failure sensitivity			IEC/EN 60947, VDE 0660 Part 102
Description			Test/off button Reset pushbutton manual/auto Trip-free release
Mounting type			Separate mounting
	$I_r$	A	70 - 100
Contact sequence			
<b>Auxiliary contacts</b>			
N/O = Normally open			1 N/O
N/C = Normally closed			1 N/C
For use with			DILM80, DILM95, DILM115, DILM150, DILM170 DIULM80, DIULM95, DIULM115, DIULM150, SDAINLM140, SDAINLM165, SDAINLM200, SDAINLM260
<b>Short-circuit protection</b>			
Type "1" coordination 	gG/gL	A	315
Type "2" coordination 	gG/gL	A	200

**Notes**

Overload release: tripping class 10 A

Short-circuit protection: Observe the maximum permissible fuse of the contactor with direct device mounting.

Suitable for protection of Ex e-motors.



II (2) GD

PTB 10 ATEX 3010

Observe manual MN03407005Z-DE/EN.

**Notes**

Separate mounting

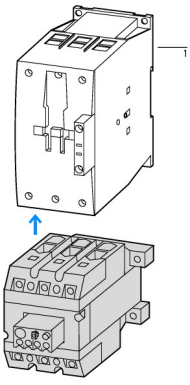

1 Contactor  
2 Bases

## Technical data

### General

Standards			IEC/EN 60947, VDE 0660, UL, CSA
Climatic proofing			Damp heat, constant, to IEC 60068-2-78 Damp heat, cyclic, to IEC 60068-2-30
Ambient temperature		°C	
			Operating range to IEC/EN 60947 PTB: -5 °C - +55 °C
Open		°C	-25 - +55
Enclosed		°C	- 25 - 40
Temperature compensation			Continuous
Weight		kg	1.64
Mechanical shock resistance		g	10 Sinusoidal Shock duration 10 ms
Degree of Protection			IP20
Protection against direct contact when actuated from front (EN 50274)			Finger and back-of-hand proof

### Main conducting paths

Rated impulse withstand voltage	$U_{imp}$	V AC	8000
Overvoltage category/pollution degree			III/3
Rated insulation voltage	$U_i$	V	1000
Rated operational voltage	$U_e$	V AC	1000
Safe isolation to EN 61140			
Between auxiliary contacts and main contacts		V AC	440
Between main circuits		V AC	440
Temperatur compensation residual error > 40 °C			 0.25 %/K
Current heat loss (3 conductors)			
Lower value of the setting range		W	16
Maximum setting		W	18
Terminal capacities		mm <sup>2</sup>	
Solid		mm <sup>2</sup>	2 x (4 - 16)
Flexible with ferrule		mm <sup>2</sup>	1 x (4 - 70) 2 x (4 - 50)
Stranded		mm <sup>2</sup>	1 x (16...50) 2 x (16...50)
Solid or stranded		AWG	2/0
Terminal screw			M10
Tightening torque		Nm	10
Tools			
Hexagon socket-head spanner	SW	mm	5

### Auxiliary and control circuits

Rated impulse withstand voltage	$U_{imp}$	V	4000
Overvoltage category/pollution degree			III/3
Terminal capacities		mm <sup>2</sup>	
Solid		mm <sup>2</sup>	2 x (0,75 - 4)

Flexible with ferrule		mm <sup>2</sup>	2 x (0.75 - 2.5)
Solid or stranded		AWG	2 x (18 - 14)
Terminal screw			M3.5
Tightening torque		Nm	0.8 - 1.2
Tools			
Pozidriv screwdriver		Size	2
Standard screwdriver		mm	1 x 6
Rated insulation voltage	U <sub>i</sub>	V AC	500
Rated operational voltage	U <sub>e</sub>	V AC	500
Safe isolation to EN 61140			
between the auxiliary contacts		V AC	240
Conventional thermal current	I <sub>th</sub>	A	6
Rated operational current	I <sub>e</sub>	A	
AC-15			
Make contact			
120 V	I <sub>e</sub>	A	1.5
220 V 230 V 240 V	I <sub>e</sub>	A	1.5
380 V 400 V 415 V	I <sub>e</sub>	A	0.5
500 V	I <sub>e</sub>	A	0.5
Break contact			
120 V	I <sub>e</sub>	A	1.5
220 V 230 V 240 V	I <sub>e</sub>	A	1.5
380 V 400 V 415 V	I <sub>e</sub>	A	0.9
500 V	I <sub>e</sub>	A	0.8
DC-13 L/R - 15 ms			
24 V	I <sub>e</sub>	A	0.9
60 V	I <sub>e</sub>	A	0.75
110 V	I <sub>e</sub>	A	0.4
220 V	I <sub>e</sub>	A	0.2
Short-circuit rating without welding			
max. fuse		A gG/gL	6

## Notes

**Notes** Ambient air temperature: Operating range to IEC/EN 60947, PTB: -5°C to +55°C  
Rated operational current: Making and breaking conditions to DC-13, time constant as stated  
Main circuits terminal capacity solid and flexible conductors with ferrules: When using 2 conductors use equal cross-sections  
6 mm flexible with ferrules to DIN 46228  
Rated operational current DC-13, 60 V: N/O auxiliary contact 0.6 A

## Design verification as per IEC/EN 61439

Technical data for design verification			
Rated operational current for specified heat dissipation	I <sub>n</sub>	A	100
Heat dissipation per pole, current-dependent	P <sub>vid</sub>	W	8.4
Equipment heat dissipation, current-dependent	P <sub>vid</sub>	W	25.2
Static heat dissipation, non-current-dependent	P <sub>vs</sub>	W	0
Heat dissipation capacity	P <sub>diss</sub>	W	0
Operating ambient temperature min.		°C	-25
Operating ambient temperature max.		°C	55
IEC/EN 61439 design verification			
10.2 Strength of materials and parts			
10.2.2 Corrosion resistance			Meets the product standard's requirements.
10.2.3.1 Verification of thermal stability of enclosures			Meets the product standard's requirements.
10.2.3.2 Verification of resistance of insulating materials to normal heat			Meets the product standard's requirements.
10.2.3.3 Verification of resistance of insulating materials to abnormal heat and fire due to internal electric effects			Meets the product standard's requirements.
10.2.4 Resistance to ultra-violet (UV) radiation			Meets the product standard's requirements.
10.2.5 Lifting			Does not apply, since the entire switchgear needs to be evaluated.

10.2.6 Mechanical impact		Does not apply, since the entire switchgear needs to be evaluated.
10.2.7 Inscriptions		Meets the product standard's requirements.
10.3 Degree of protection of ASSEMBLIES		Does not apply, since the entire switchgear needs to be evaluated.
10.4 Clearances and creepage distances		Meets the product standard's requirements.
10.5 Protection against electric shock		Does not apply, since the entire switchgear needs to be evaluated.
10.6 Incorporation of switching devices and components		Does not apply, since the entire switchgear needs to be evaluated.
10.7 Internal electrical circuits and connections		Is the panel builder's responsibility.
10.8 Connections for external conductors		Is the panel builder's responsibility.
10.9 Insulation properties		
10.9.2 Power-frequency electric strength		Is the panel builder's responsibility.
10.9.3 Impulse withstand voltage		Is the panel builder's responsibility.
10.9.4 Testing of enclosures made of insulating material		Is the panel builder's responsibility.
10.10 Temperature rise		The panel builder is responsible for the temperature rise calculation. Eaton will provide heat dissipation data for the devices.
10.11 Short-circuit rating		Is the panel builder's responsibility. The specifications for the switchgear must be observed.
10.12 Electromagnetic compatibility		Is the panel builder's responsibility. The specifications for the switchgear must be observed.
10.13 Mechanical function		The device meets the requirements, provided the information in the instruction leaflet (IL) is observed.

## Technical data ETIM 5.0

Low-voltage industrial components (EG000017) / Thermal overload relay (EC000106)		
Electric engineering, automation, process control engineering / Low-voltage switch technology / Overload protection device / Thermal overload relay (ecl@ss8-27-37-15-01 [AKF075010])		
Adjustable current range	A	70 - 100
Mounting method		Direct attachment
Connection type main current circuit		Screw connection
Number of auxiliary contacts as normally closed contact		1
Number of auxiliary contacts as normally open contact		1
Number of auxiliary contacts as change-over contact		0
Release class		CLASS 10

## Approvals

Product Standards		UL 508; CSA-C22.2 No. 14; IEC/EN 60947-4-1; IEC/EN 60947-5-1; CE marking
UL File No.		E29184
UL Category Control No.		NKCR
CSA File No.		12528
CSA Class No.		3211-03
North America Certification		UL listed, CSA certified
Specially designed for North America		No
Suitable for		Branch circuits
Max. Voltage Rating		600 V AC
Degree of Protection		IEC: IP00, UL/CSA Type: -

## Characteristics

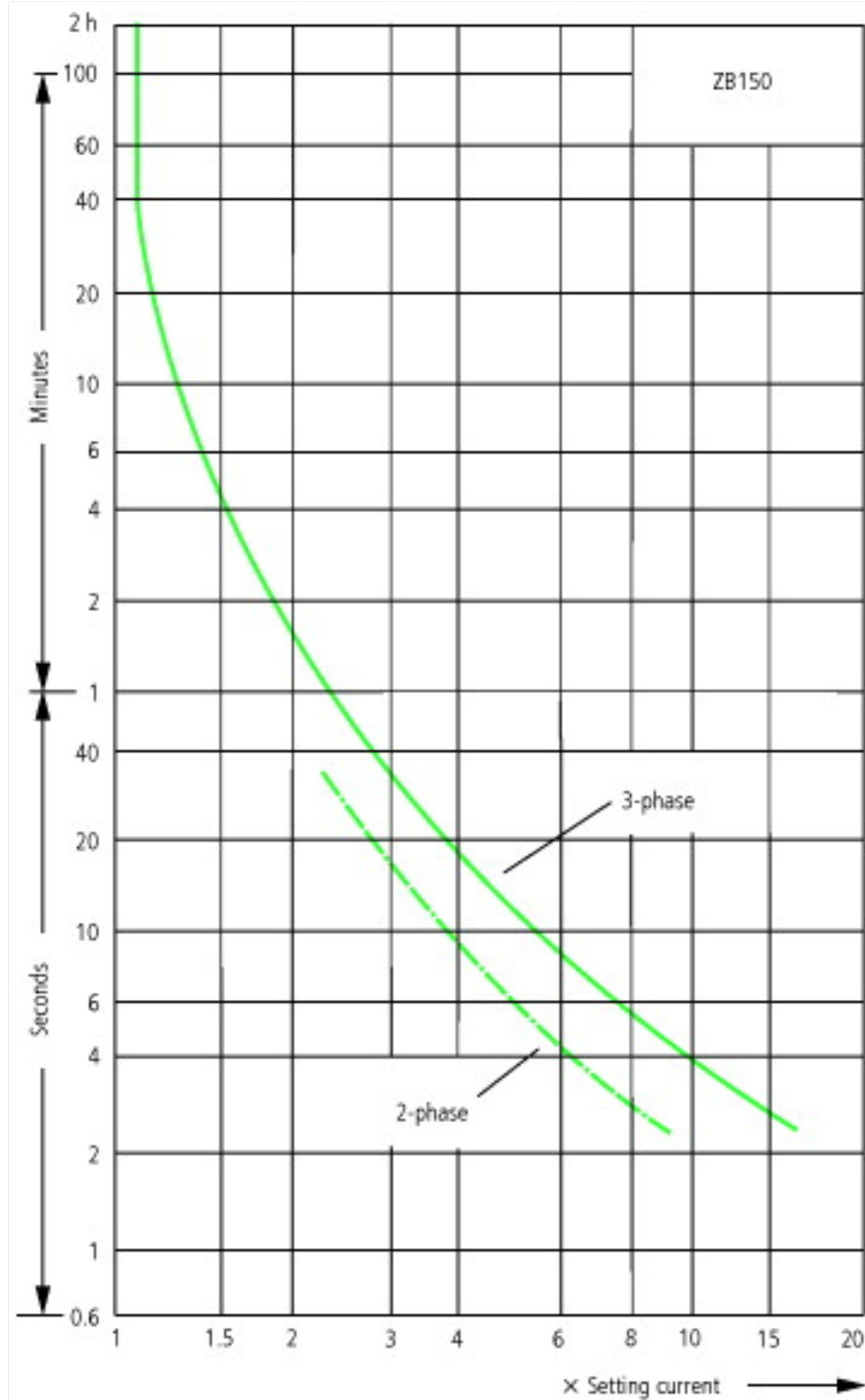

These tripping characteristics are mean values of the spread at 20 °C ambient temperature in a cold state. Tripping time depends on response current. On devices at operating temperature the tripping time of the overload relay drops to approx. 25 % of the read value. Specific characteristics for each individual setting range can be found in the manual.

## Dimensions

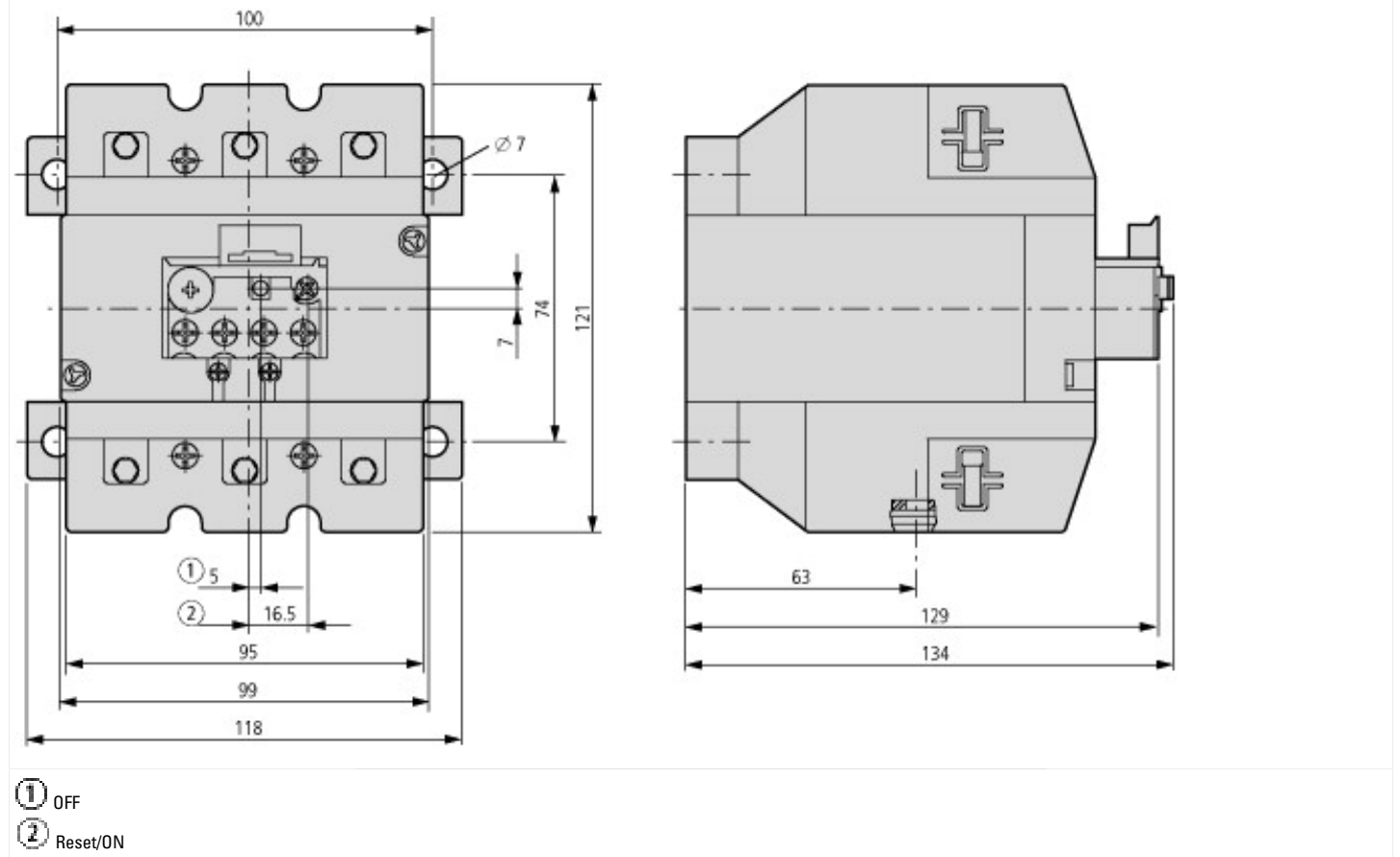

## Additional product information (links)

IL03407006Z (AWA2300-1276) Overload relay

IL03407006Z (AWA2300-1276) Overload relay [ftp://ftp.moeller.net/DOCUMENTATION/AWA\\_INSTRUCTIONS/IL03407006Z2014\\_08.pdf](ftp://ftp.moeller.net/DOCUMENTATION/AWA_INSTRUCTIONS/IL03407006Z2014_08.pdf)