



## Preface

Thank you for purchasing the FAB Intelligent Controls Series (FAB) products of our company. We recommend that you take some time to read this manual, before putting the FAB products in to service. The FAB has, amongst many features, the advantage being able to be operated off line to prove in service performance before being commissioned into service. When you read the manual you will find many more advantageous properties of the products, it will greatly simplify the operation of FAB for you.

FAB is a type of intelligent control, which uses function blocks for programming. Function blocks enable the control functions of a PLC to be achieved without the need for large number of instructions and complicated programming. When several function blocks are linked together in a specific way, relatively complicated control functions can be implemented. The programming can be carried out in a logical, speedy and verifiable manner. Programming can be implemented using a removable LCD liquid crystal display panel or by use of a computer. The latter approach is recommended for more complicated control schemes.

FAB has a very wide range of applications. It can be used for the automation of an extensive range of electrical and mechanical equipment. Flow control, building automation and many other fields. The implementation of FAB provides for automation of very many aspects of day-to-day life from home through to the commercial, manufacturing, mining, utility and service sectors of the economy. This manual will describe in detail the functional characteristics and operating methods for FAB, its' ancillary components and associated Quick II and FAB Scada operating software.

### *Notes:*

*Copyright of this manual and patent of FAB Intelligent Controls Series are the property of ARRAY ELECTRONIC CO., LTD. No reproduction or duplication of all or part of the contents of this manual is permitted without written consent in advance.*

*Our company reserves the right to make changes in design for improvement FAB Intelligent Controls Series without notification.*

*Any comments directed towards the improvement in the quality of this manual will be appreciated.*

A decorative graphic element consisting of a horizontal line that curves downwards at the right end, located at the bottom right of the page.



**FAB HARDWARE**

A. IMPORTANT APPLICATION NOTES.....2  
B. SAFETY GUIDE.....3

**Chapter I Brief Introduction to FAB**

1.1 Structure of FAB.....4  
1.2 Specifications and models.....5  
1.3 Features of FAB.....6

**Chapter II Installation and connections of FAB**

2.1 Installation.....10  
    2.1.1. Installation methods.....10  
    2.1.2 Dimensions.....11  
2.2 Wiring of FAB.....12  
    2.2.1 Connection of power supply.....12  
    2.2.2 Connecting FAB inputs.....12  
    2.2.3 Connecting FAB outputs.....14  
    2.2.4 Connecting FAB network.....16

**Chapter III General Description of Function Blocks**

3.1 General function block (GF).....17  
    3.1.1 AND.....18  
    3.1.2 OR .....19  
    3.1.3 NOT.....19  
    3.1.4 NAND.....20



|                                       |    |
|---------------------------------------|----|
| 3.1.5 NOR.....                        | 21 |
| 3.1.6 XOR.....                        | 21 |
| 3.2 Special function blocks (SF)..... | 22 |
| 3.2.1 DPR.....                        | 24 |
| 3.2.2 DDR.....                        | 25 |
| 3.2.3 PLR.....                        | 26 |
| 3.2.4 CW.....                         | 27 |
| 3.2.5 RS.....                         | 33 |
| 3.2.6 CPG.....                        | 34 |
| 3.2.7 RPR.....                        | 35 |
| 3.2.8 UCN.....                        | 37 |
| 3.2.9 DCN.....                        | 38 |
| 3.2.10 MPLR.....                      | 38 |
| 3.2.11 TEL FAB.....                   | 39 |
| 3.2.12 PLAY.....                      | 41 |
| 3.2.13 MR.....                        | 42 |
| 3.2.14 COMP.....                      | 43 |

**Chapter IV Programming operation on FAB panel**

|                                |    |
|--------------------------------|----|
| 4.1 Display status of FAB..... | 46 |
| 4.2 Confirm password .....     | 46 |
| 4.3 Function .....             | 47 |
| 4.3.1 Editor .....             | 48 |
| 4.3.1.1 Edit PRG .....         | 48 |
| 4.3.1.2 Insert FB.....         | 55 |



|   |    |
|---|----|
| 4.3.1.3 Delete FB.....                      | 56 |
| 4.3.1.4 Clear Prg.....                      | 57 |
| 4.3.2 FAB/Rom .....                         | 57 |
| 4.3.2.1 Read program from FAB(Rom→FAB)..... | 58 |
| 4.3.3 SET.....                              | 58 |
| 4.4 Edit FAB function program.....          | 59 |
| 4.4.1 Programming rules.....                | 59 |
| 4.4.2 Middle relay.....                     | 60 |
| 4.4.3 Edit program.....                     | 61 |

#### Chapter V Remote programming and monitoring

|  |    |
|--|----|
| 5.1 Remote programming and monitoring via a MODEM.....                       | 72 |
| 5.2 Two connection methods for FAB remote<br>programming and monitoring..... | 73 |
| 5.2.1 Connect MODEM by means of AF-C232 and AF-M232.....                     | 73 |
| 5.2.2 Connect MODEM by means of AF-MUL.....                                  | 73 |

#### Chapter VI Voice Module

|  |    |
|--|----|
| 6.1 The structure of the voice module:.....            | 75 |
| 6.2 Connection of AF-MUL and FAB.....                  | 76 |
| 6.3 Guide for using the voice multifunction block..... | 76 |
| 6.4 Recording.....                                     | 79 |
| 6.5 Sound broadcasting.....                            | 81 |
| 6.6 Telephone remote control function.....             | 81 |



6.7 Automatically dial function.....82  
6.8 Example for using the voice module for control and security.....82

**Chapter VII Technical specifications**

7.1 General technical specifications.....85  
7.2 AF-10AMR /AF-20AMR.....86  
7.3 AF-10DMT / AF-20DMT.....87  
7.4 AF-10DMR / AF-20DMR.....88  
7.5 Telephone number receiving , transmitting and voice blocks.....89

**Chapter VIII Application**

8.1 Bell control of schools or factories.....91  
8.2 The illumination of multifunction switch in stairs, halls etc.....93  
8.3 Automatic gate control requirements.....94  
8.4 Ventilation system.....95  
8.5 Control requirements for neon lamp control system.....96  
8.6 Illumination system for display windows.....98  
8.7 Application of FAB in building management.....99  
8.8 Application of FAB in a voltage diode counting  
and packing assembly line.....101

**Chapter VIII Quality Guarantee**

Quality guarantee, warranty period and warranty range.....103



**QUICKII: PROGRAMMING SOFTWARE OF FAB**

Chapter I Brief Introduction to QUICKII

1.1 Operating interface.....107

1.2 Two types of editing windows.....108

    1.2.1 FAB logical diagram editing window.....108

    1.2.2 Simulation window.....109

1.3 Main functions.....110

    1.3.1 Editing function.....110

    1.3.2 Simulation operation function.....111

    1.3.3 Real-time monitoring.....111

    1.3.4 Communication with FAB.....111

        1.3.4.1 Local FAB communication.....111

        1.3.4.2 Remote FAB communication.....111

Chapter II Installation and uninstallation

2.1 Installation of Quick II.....112

2.2 Uninstallation .....117

Chapter III Operation Instructions and Block Library

3.1 Function Instructions.....119

    3.1.1 File.....119

    3.1.2 Controller.....120

    3.1.3 Communication.....120

    3.1.4 Display.....121



|   |     |
|---|-----|
| 3.1.5 Options:.....                                 | 122 |
| 3.1.6 Help:.....                                    | 122 |
| 3.1.7 Edit:.....                                    | 123 |
| 3.1.8 Search:.....                                  | 124 |
| 3.1.9 Image Library:.....                           | 124 |
| 3.1.10 FAB operation.....                           | 125 |
| 3.1.11 Windows.....                                 | 125 |
| 3.2 Tool Bar.....                                   | 126 |
| 3.2.1 Standard Tool Bar.....                        | 126 |
| 3.2.2 Control Tool Bar.....                         | 127 |
| 3.2.3 Draw Tool Bar for Field Simulation Graph..... | 127 |
| 3.3 Block Library.....                              | 128 |
| 3.3.1 Block Library Operation.....                  | 128 |
| 3.3.2 Block classification.....                     | 129 |
| 3.3.3 Setup of block property.....                  | 129 |
| 3.3.3.1 General Property.....                       | 129 |
| 3.3.3.2 Setup of Special Property .....             | 130 |

Chapter IV Basic operations

|  |     |
|--|-----|
| 4.1 Open File.....                     | 140 |
| 4.1.1 Open a new file.....             | 140 |
| 4.1.2 Open an existing file .....      | 142 |
| 4.2 Edit Function Diagram Program..... | 143 |



4.2.1 Place block.....143

4.2.2 Edit block properties.....146

4.2.3 Link.....148

4.2.4 Move the link or block:.....151

4.2.5 Delete block or link.....151

4.2.6 Simulation operation .....151

4.2.7 Save and Print .....152

4.2.8 Write/Read: .....154

4.3 Plot Field Simulation Graph.....157

4.3.1 Plot with Draw Icons:.....157

4.3.2 Insert Graph File directly.....158



**FAB-SCADA SOFTWARE**

Chapter 1 Introduction to FAB-SCADA System

1.1 General Introduction.....161

1.2 Network Structure of FAB.....161

    1.2.1 Network of RS485 Buses.....162

    1.2.2 Network System for Remote Control via a Modem.....162

1.3 More detailed Introduction to the FAB-Scada System.....163

Chapter 2 Installation of FAB-Scada System

Chapter 3 Operation Instructions and Quick icons

3.1 Instructions and Icons in the Control Interface.....168

    3.1.1 System (Operation Instructions for System Management).....168

    3.1.2 Monitor (Operation Instructions for Monitor Setup).....168

    3.1.3 User (Users Management Instructions).....169

    3.1.4 Query (Query Instructions of the System).....169

    3.1.5 Report.....170

    3.1.6 Tools.....170

    3.1.7 Help.....170

3.2 Operation Instructions and Quick icons

    in the Drawing Interface.....171

    3.2.1 File (Files management).....171

    3.2.2 Edit.....171

    3.2.3 Tools.....172

    3.2.4 Help.....172



Chapter 4 Build a Supervisory Control System

- 4.1 Station design.....173
- 4.2 Add/Delete FAB.....175
- 4.3 Define the FAB I/O Port.....177
- 4.4 Drawing Monitoring Interface.....183
  - 4.4.1 Operation Instruments In Drawing Interface.....183
  - 4.4.2 Drawing Tools.....184
  - 4.4.3 Drawing the Monitoring Diagram.....186
    - 4.4.3.1 Page Setting.....186
    - 4.4.3.2 Draw the Monitor Diagram.....187
    - 4.4.3.3 Analyse the Communicating State.....196

Chapter 5 User Management

- 5.1 Modify Manager Name.....197
- 5.2 User Management.....197
  - 5.2.1 Append.....198
  - 5.2.2 Delete.....198
  - 5.2.3 Modify the Password.....198
  - 5.2.4 Query the User Information.....199
- 5.3 User Login.....199
- 5.4 User Logout.....200
- 5.5 Explanations for User Authorities.....200

Chapter 6 System Configuration

- 6.1 Set FAB Time.....201
- 6.2 Print.....201
- 6.3 Deploy.....202



Chapter 7 Data Query

|                                |     |
|--------------------------------|-----|
| 7.1 Data Query.....            | 204 |
| 7.2 Back-up the Data Base..... | 206 |

Chapter 8 Report

|                          |     |
|--------------------------|-----|
| 8.1 Create a Report..... | 208 |
| 8.2 Browse.....          | 213 |



# FAB HARDWARE

## FAB Intelligent Control

---



A.

### IMPORTANT APPLICATION NOTES:

1. The AF-C232 and LCD board, when a FAB is powered, must not be plugged in or disconnected.
2. The default password for FAB is 0001.
3. The default address for FAB is 000.
4. When programming a FAB using the LCD panel, the output of two function blocks must not be connected to one point, except for the CW function block.

For example:

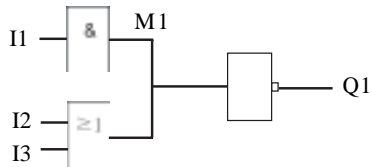

The above way is wrong, and the correct way is as follows:

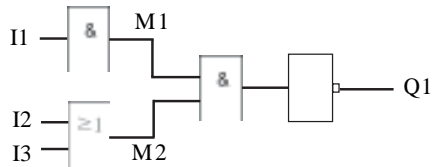



**B.**

**SAFETY GUIDE:**

*This manual contains the precautions necessary for ensure your personal safety as well as for protection of the products and the connected equipment. These precautions are highlighted with a triangle WARNING symbol in this manual and are marked according to the danger levels as following:*



**Danger**

*It indicates that if appropriate precautions are not taken, serious incidents of personal injury or death, significant damage and loss of property will be caused.*



**Caution**

*It indicates that if appropriate precautions are not taken, incidents of personal injury, damage or some loss of property will be caused.*



**Note**

*Indicates that particular attention is required to all published information related to the use or disposal of products. Also in specific parts of documentation*



**Warning**

*Only suitably qualified personnel are allowed to operate and debug the products. Qualified personnel are specified as those persons who carry out commissioning, grounding and apply the appropriate identification to the circuits, equipment and systems according to the available safety practices and standards.*



**Note**

*Only when this product is transported and stored with care, then assembled, installed, operated and maintained in accordance with the documentation, can it carry out its' designed functions properly and reliably.*



## Chapter I Brief Introduction to FAB

FAB intelligent controller is a new type of programmable controller. It is programmed by the use of a Function Block Diagram. The programming of FAB is simpler and easier to learn than the programming of a conventional PLC, that uses ladder diagrams and associated instructions. The design concept, for the FAB series of products, includes a removable LCD panel. The program can be written directly into the FAB using this LCD panel. After programming the LCD panel can be retained or removed and replaced with a cover. The cost to the user can be reduced by multiple use of the LCD panel. The use of a computer is recommended for more complex control schemes.

Products within the FAB series are very compact and light in weight. FAB intelligent controls series can be used for both local and remote control, communication, networking and monitoring. FAB series can realize telephone-control, voice alarm and information, automatic dialing using the associated FAB-MUL unit. FAB is widely used in many fields of industry, commerce, mining, agriculture, home automation etc.

### 1.1 Structure of FAB

FAB-10 series

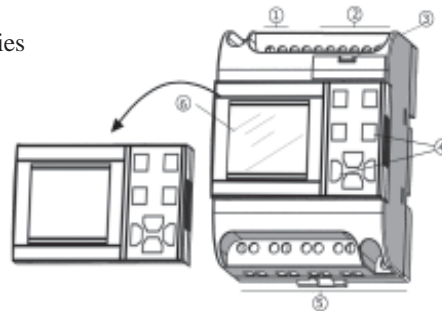

1. Terminals for AC or DC power as required by the selected FAB
2. Input terminals
3. Communication interface
4. Operating keys
5. Output terminals (Relay or transistor)
6. LCD display panel

## Chapter I Brief Introduction

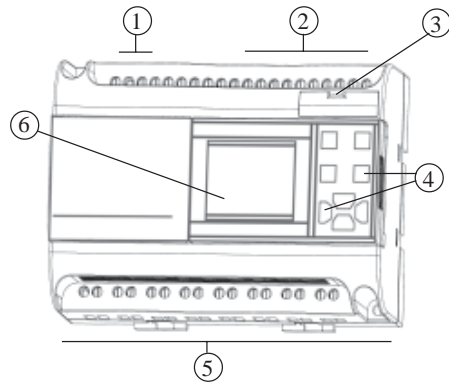

FAB-20 series

1. Terminals for AC or DC power, as required by the selected FAB
2. Input terminals
3. Communication interface
4. Operating keys
5. Output terminals (Output of relays or transistors)
6. LCD display panel

### 1.2 Specifications and models of FAB

| Type No  | Power        | Input                         | Output                     |
|----------|--------------|-------------------------------|----------------------------|
| AF-10AMR | AC 100V-240V | 6 points AC digital input     | 4 points relay output      |
| AF-10EMR | AC/DC 12-24V | 6 points AC/DC digital input  | 4 points relay output      |
| AF-10EMT | DC 12-24V    | 6 points AC/DC digital input  | 4 points transistor output |
| AF-10DMR | DC 12-24V    | 6 points DC analog input      | 4 points relay output      |
| AF-10DMT | DC 12-24V    | 6 points DC analog input      | 4 points transistor output |
| AF-20AMR | AC 100V-240V | 12 points AC digital input    | 8 points relay output      |
| AF-20EMR | AC/DC 12-24V | 12 points AC/DC digital input | 8 points relay output      |

## FAB Intelligent Control

---



| Type No  | Power   | Input                         | Output                     |
|----------|---|-------------------------------|----------------------------|
| AF-20EMT | DC 12/24V   | 12 points AC/DC digital input | 8 points transistor output |
| AF-20DMR | DC 12-24V   | 12 points DC analog input     | 8 points relay output      |
| AF-20DMT | 12-24V  | 12 points DC analog input     | 8 points transistor output |
| AF-LCD   | FAB removable LCD panel.                            |                               |                            |
| AF-C232  | Interface between AF-M232 and FAB                   |                               |                            |
| AF-C485  | Interface between FAB and RS485 bus                 |                               |                            |
| AF-P485  | Interface between computer and RS485 bus.           |                               |                            |
| AF-M232  | Adapter between MODEM and AF-MUL or AF-C232         |                               |                            |
| AF-MUL   | Voice alarm, telephone control and dial automation. |                               |                            |
| AF-MUL-D | DC type voice module                                |                               |                            |
| QUICK II | FAB programming software                            |                               |                            |
| AF-Scada | SCADA software                                      |                               |                            |

### 1.3 Features of FAB

#### 1. Removable programming panel with Liquid Crystal Display

There is an operating panel with LCD display on the front side of FAB. You can use the operating keys on this panel to edit directly the control program for FAB. Moreover, this LCD display panel is removable, and it can be set up according to your needs. When needed it can be plugged in. When not needed it can be removed and replaced with a front cover,

#### Caution



*The LCD display panel shall be plugged in or removed only after AC or DC power has been turned off*



2. Well featured and compact design  
If you are thinking of improving the application of your equipment, FAB provides very many features. FAB is very compact, 90mm x 71mm x 58mm ( FAB-10 Series) and 90mm x 126mm x 58mm(FAB-20 Series)
3. With the function blocks used for programming, the program storage capacity of FAB is large. The control functions of FAB can be implemented only with function blocks incorporated into a function block diagram. The same level of control implemented by a conventional PLC would require a much larger and more detailed program. When several function blocks are linked together in a specific way, then relatively complicated control functions can be implemented. FAB has a storage capacity of programs for up to 127 function blocks, there is a large application resource to satisfy the requirements for complicated control. A program, when downloaded into FAB will never be lost as FAB does not rely on a battery for the memory function.
4. QUICK II: programming software.  
The control program can be downloaded directly, with the use of the LCD panel, into a FAB unit. With more complicated control schemes the use of an ancillary computer, loaded with QUICK II software, is recommended. The control program can then be written into the memory of the FAB. QUICK II is a very friendly human-machine interface programming software. It can edit the function diagrams and also can analogously run the written program. It provides an off-line testing function to the user. This feature overcomes much of the possible inconveniences normally experienced with on-line testing and commissioning. The system can be proven before being put into actual service. QUICK II will not only guide you to implement the editing of the control programs, but will also perform the real-time monitoring for the field environment and the operational conditions of FAB.
5. Real-time clock function  
FAB intelligent controls Series have an instant real-time recording function. FAB can execute the operations according to the planned schedule. Up to 127 different time intervals can be set, it is very suitable for systems which require time control.
6. Analog input and transmission  
In addition to receiving a switching input, FAB can also receive the

## FAB Intelligent Control

---



analog input to implement the control of temperature, humidity, pressure, flow, level unit, etc., and transmit them remotely to a computer for monitoring.

7. To implement the remote programming and the supervision and control of data acquisition through MODEM.

When you need to implement programming, write and modify programs for FAB controls from a remote location it is necessary to connect FAB to MODEM through a touch telephone. With this connection it is possible to perform data acquisition and real-time supervision and control from a remote location.

8. Security cipher code function

FAB is provided with protection for the programs downloaded into it. A security cipher code can be set before programs are written. The programs can then only be modified after the correct cipher code is entered.

9. Telephone function

FAB is equipped with telephone and voice function blocks. It is possible to dial directly through a telephone line after the required telephone number has been preset. FAB can be dialed automatically, when the conditions are satisfied so as to implement advice or alarm functions. Moreover, FAB can also receive remote signals transmitted through a telephone line in order to control the terminal equipment.

**Note:**

*It is necessary to configure FAB-MUL multifunctional voice block for the implementation of telephone function and voice function.*

10. Voice function

FAB can provide voice recording and broadcasting back functions for the automatic control industry, creating intelligent controls which can give audible voice outputs, both locally and through remote speakers.

11. Networking function

FAB has a networking function. It can link up to 255 FABs to make up a network to implement the instant supervision and control from a common computer.



12. FAB-Scada monitoring and control functions.

FAB Scada software provides for the monitoring and control functions of a group of FABs.

13. Middle relay feature.

With the addition of the middle relay more complicated control schemes can be developed.

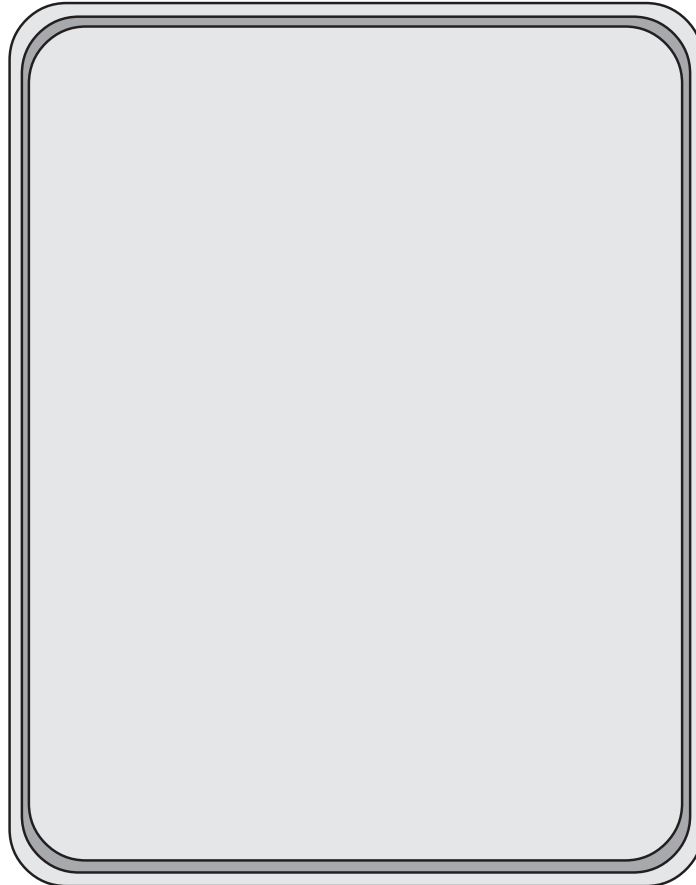



**Chapter II Installation and wiring of FAB**

**2.1 Installation**

**2.1.1. Installation method**

FAB is small and it is suitable for fitting inside panels or machinery within its' specification criteria. The installation of FAB is quite simple:

- 1. Use a standard DIN rail for installation of FAB as shown in Fig. 2.1.
- 2. Use the two diagonal clearance holes on FAB for direct mounting.

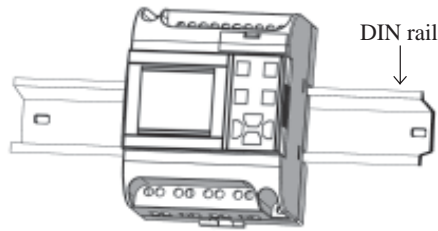

**Fig. 2.1 Use standard DIN rail for installation of FAB**

The LCD panel of FAB is readily removed by partially withdrawing it from the FAB, as illustrated, using a spade tipped screwdriver. The LCD panel can then be readily fully withdrawn manually.



**Caution:**

*Do not remove the LCD panel whilst the FAB is powered, otherwise the FAB and LCD panel may be damaged and endanger the personal safety of the user.*



**Fig. 2.1 Remove LCD panel as instructed**

2.1.2 Dimensions

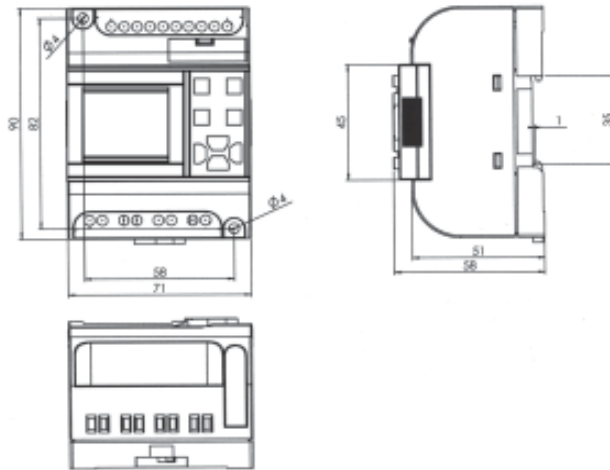

Fig 2.3 FAB-10 Series installation dimensions (Unit: mm)

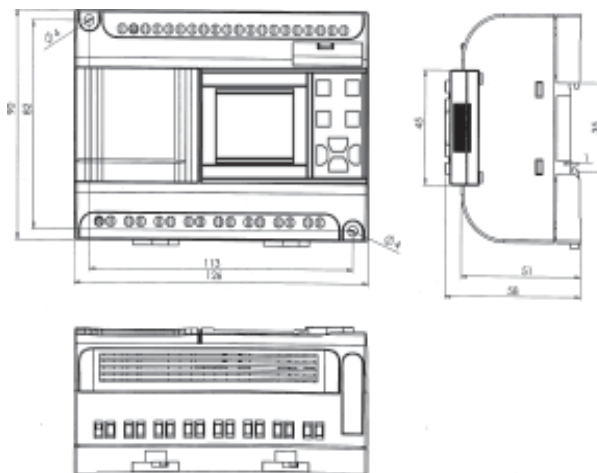

Fig 2.3 FAB-20 Series installation dimensions (Unit: mm)



## 2.2 Wiring of HP

A screwdriver with a spade tip width of 3mm is used for the wiring of HPs. The maximum cross sections of the wires that can be inserted into the terminals are determined according to the following sizes:

- 1 x 2.5mm<sup>2</sup>
- 2 x 1.5mm<sup>2</sup>

### 2.2.1 Connection of power supply

1. For AF-10AMR and AF-20AMRs, the rated power supply requirement is 100-240VAC, 50/60HZ.
2. For AF-10EMT, AF-10DMR, AF-10DMT, AF-20EMT, AF-20DMR, AF-20DMTs, the rated power supply requirement is 12-24V DC.
3. For AF-10EMR and AF-20EMRs, the rated power supply requirements are 12-24V AC or 12-24V DC.

The power connection for FABs is as shown in the following drawings:

### 2.2.2 Connecting FAB inputs

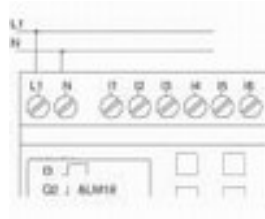

Fig 2.5 AC Type

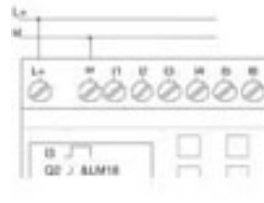

Fig 2.6 DC and AC/DC Type

The input to FAB can be either digital, such as on/off switches etc., or analog, such as pressure, temperature, humidity, flow, etc. The specific requirements are as follows:

## Chapter II Installation and wiring



| Type<br>Demand                                | AF-10AMR<br>AF-20AMR  | AF-10DMR<br>AF-10EMT<br>AF-10DMT<br>AF-20DMR<br>AF-20EMT<br>AF-20DMT | AF-10EMR<br>AF-20EMR       |
|---|---|--|----------------------------|
| Switch status 0                               | <40VAC  | <5VDC  | <5VDC                      |
| Input current                                 | <0.24mA   | <1.5mA   | <1.5mA                     |
| Switch status 1                               | >=80VAC   | >=10VDC  | >=10VDC                    |
| Input current                                 | Typical 0.24mA  | Typical 3mA  | Typical 3mA                |
| Proximity switch<br>type with direct<br>input | 2lines<br>3lines<br>4lines  | 2lines<br>3lines<br>4lines   | 2lines<br>3lines<br>4lines |
| Switch<br>with glow<br>lamp                   | When the close current of a glow lamp is less than or equal to 0.2mA, it can be connected directly, and when the close current of a glow lamp is greater than 0.2mA, the glow lamp should be connected through a relay or an additional N-type drive. | /  | /                          |
|   |   | I1-I6/I1-Ic<br>receivable analog<br>value                            | /                          |

**Note:** For AF-10DMR, AF-10DMT, AF-20DMR and AF-20DMT that can receive analog input, analog can be input though all input interfaces (I1-I6 or I1-Ic). They can be set to analog input or digital input as either may be used in the program. They will be recognized as analog inputs when the input terminal is connected with an AN function block, and they will be recognized as digital inputs when the input terminal is not connected with an AN function block. You need to set analog inputs first when you use FAB-Scada software for supervision.

The analog inputs require 0V ~ +10V voltage signals. These are divided equally in 0.1V increments. In programming, all the block parameters related to the analog inputs are based on the minimum increment of 0.1V. They can be recognized as digital input when the input voltage is more than 10.0V and cannot be recognised as an analog input.

For the digital input off, when the switch status changes from 0 to 1, the time of Status 1 must be greater than 50ms, and when the switch status changes from 1 to 0, the time of Status 0 also must be greater than 50ms.



Connecting FAB is shown as in the following figure:

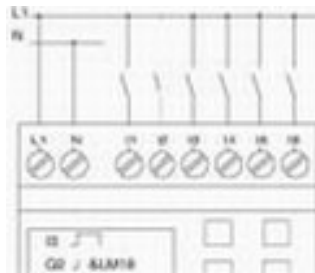

Fig 2.7 AC Type

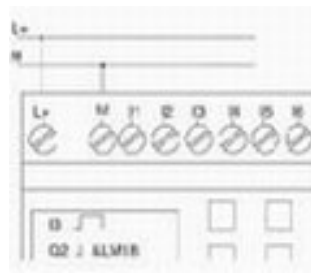

Fig 2.8 DC Type ( E Type)

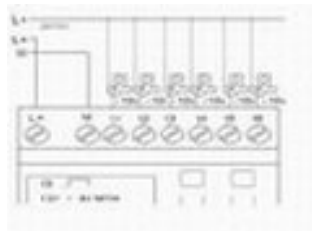

Fig 2.9 DC Type ( D Type)

### 2.2.3 Connecting FAB output

For AF-10AMR/AF-20AMR/AF-10DMR/AF-20DMR/AF-10EMR/AF-20EMR series, the output are relays.

The contacts of relays are insulated from the power supply and input.

For AF-10EMT/AF-20EMT and AF-10DMT/AF-20DMT Series, the output are of transistor type, provided with short circuit and overload protection. It is necessary to have a separate power supply for their loads.



1. Requirement for the relay output

Various loads such as lamp, fluorescent tube, motor, contactor, etc., can be connected to the outputs of FABs. The max. ON output current that can be supplied by FAB, is 10A for the resistance load and 2A for the inductive load. The connection is in accordance with the following figure 2.10:

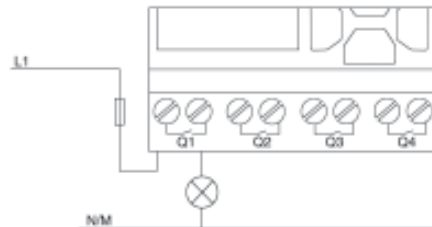

Fig 2.10 Relay Output

2. Requirement for the electronic transistor output

The load connected to FAB must have the following characteristics:  
The maximum switch current cannot exceed 2A  
when the switch is ON (Q=1), the maximum current is 2A.  
The connection is in accordance with the following figure 2.1:

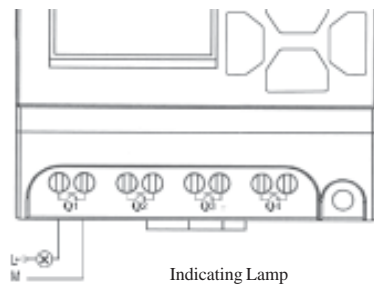

Fig. 2.1 Transistor Output



*Note: M line should be connected to M of FAB Power supply, and the load should be directly connected the L+ 1, and the load current should be DC .*



2.2.4 Connecting FAB network

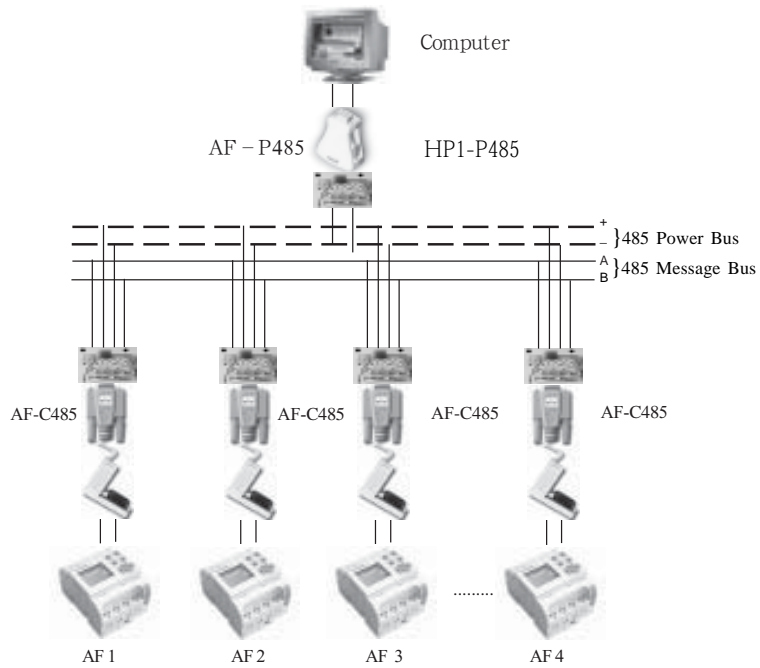
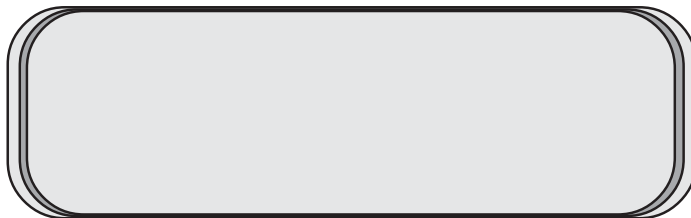

Fig. 2.12 Connecting method



**Note:**

One PC can be connected with up to 255 FABs. Please set addresses respectively for each FAB. The address range is 000~254.





**Chapter III General Description of Function Blocks**

FAB series adopts the programming method with the use of function blocks. 20 function blocks are configured in total, and each block can achieve a specific control function independently, e.g. time-delay ON, time-delay OFF, setting switch time, counter function, etc. As several blocks are linked up in a specific way relatively complicated control functions can be realised. Programming with function blocks is simpler and better appreciated than the conventional PLC instruction programming.

The following types of operator for FAB function blocks are available for options:

1. Options of input port: I1 - IC (Input port), Q1- Q8 (Output port), Moo-M126 (middle relay), HI (High potential status), LO (Low potential status), X (no input connection), P0 - P9 (Telephone two-tone pulse)
2. Options for output port: Q1 ~ Q8 (output port), Moo~M126 (intermediate relay).

**3.1 General function block (GF)**

There are 6 general function blocks in total as listed in the following table:

Table 1: General function blocks

| Line diagram                       | FAB function block | Function |
|------------------------------------|--------------------|----------|
| Series Connection of NO contacts   |                    | AND      |
| Parallel connection of NO contacts |                    | OR       |
| Phase inverter                     |                    | NOT      |



|                                    |  |      |
|------------------------------------|--|------|
| Dual commutator contact            |  | XOR  |
| Parallel connection of NC contacts |  | NAND |
| Serial connection of NC contacts   |  | NOR  |

### 3.1.1 AND

Serial connection of a certain number of NO contacts is shown in the line diagram as follow:

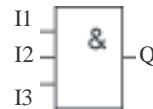
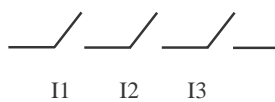

The symbol of AND is as shown in the follows:

This function block is called as AND, because only when all of I1, I2 and I3 are all in status 1, the status of Output Q will be 1 (i.e. the output is closed).  
Logical frame of AND.

| I1 | I2 | I3 | Q |
|----|----|----|---|
| 0  | 0  | 0  | 0 |
| 0  | 0  | 1  | 0 |
| 0  | 1  | 0  | 0 |
| 0  | 1  | 1  | 0 |
| 1  | 0  | 0  | 0 |
| 1  | 0  | 1  | 0 |
| 1  | 1  | 0  | 0 |
| 1  | 1  | 1  | 1 |



**3.1.2 OR**

Parallel connection of a certain number of NO contacts, is shown in the electrical line diagram as follows:

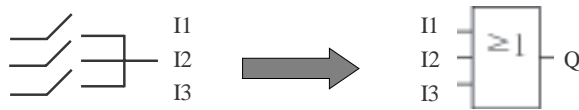

This function block is called as OR, because the status for at least one of inputs I1 or I2 or I3 is 1 (i.e. close), then output Q is 1.

Logical frame of OR”:

| I1 | I2 | I3 | Q |
|----|----|----|---|
| 0  | 0  | 0  | 0 |
| 0  | 0  | 1  | 1 |
| 0  | 1  | 0  | 1 |
| 0  | 1  | 1  | 1 |
| 1  | 0  | 0  | 1 |
| 1  | 0  | 1  | 1 |
| 1  | 1  | 0  | 1 |
| 1  | 1  | 1  | 1 |

**3.1.3 NOT**

This function block is called NOT, because the input status is 0, Output Q is 1, and vice versa. In other words, NOT is the phase inverter for the input point.

The phase inverter is indicated in the line diagram as follows:

The phase inverter is called as NOT in FAB, its symbol is as follows:





Logical frame of NOT:

| I1 | Q |
|----|---|
| 0  | 1 |
| 1  | 0 |

### 3.1.4 NAND

Parallel connection of certain number of NC contacts, which is shown in the electrical line diagram as follows:

The symbol of NAND in FAB is shown as follows:

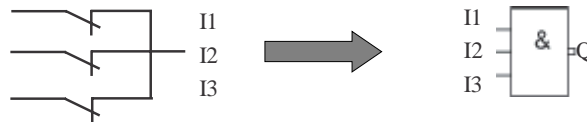

This function block is called NAND, because only when all I1, I2 and I3 are all in status 1 (i.e. close), its Output Q is in status 0.

Logical frame of AND”:

| I1 | I2 | I3 | Q |
|----|----|----|---|
| 0  | 0  | 0  | 1 |
| 0  | 0  | 1  | 1 |
| 0  | 1  | 0  | 1 |
| 0  | 1  | 1  | 1 |
| 1  | 0  | 0  | 1 |
| 1  | 0  | 1  | 1 |
| 1  | 1  | 0  | 1 |
| 1  | 1  | 1  | 0 |



### 3.1.5 NOR

Parallel connection of a certain number of NC contacts, which is shown in the line diagram as follows:

The symbol of NOR in FAB is shown as follows:

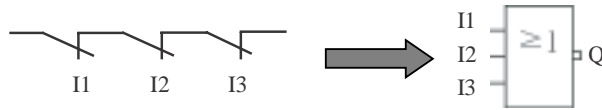

Only when all the input of NOR function blocks are at a low potential (status 0), the output will be closed (status 1). If any input is at high potential (status 1), the output will be open (status 0).

Logical frame of NOR:

| I1 | I2 | I3 | Q |
|----|----|----|---|
| 0  | 0  | 0  | 1 |
| 0  | 0  | 1  | 0 |
| 0  | 1  | 0  | 0 |
| 0  | 1  | 1  | 0 |
| 1  | 0  | 0  | 0 |
| 1  | 0  | 1  | 0 |
| 1  | 1  | 0  | 0 |
| 1  | 1  | 1  | 0 |

### 3.1.6 XOR

As shown in the line diagram, the two commutator contacts for XOR are connected in serial as follows:

In FAB, the symbol of XOR is shown as follows:

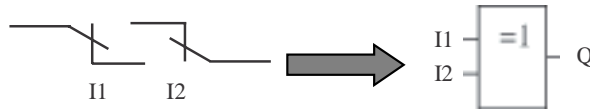



When the status of input are not the same, the output status of XOR is 1.

When the status of input are the same, the output status of XOR is 0.







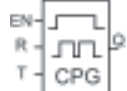
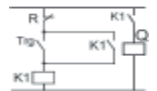

Logical frame of XOR.

| I1 | I2 | Q |
|----|----|---|
| 0  | 0  | 0 |
| 0  | 1  | 1 |
| 1  | 0  | 1 |
| 1  | 1  | 0 |

3.2 Special function blocks (SF)

| Function             | Representation | Graphic |
|----------------------|----------------|---------|
| DPR (ON time delay)  |                |         |
| DDR (OFF time delay) |                |         |
| PLR (Pulse relay)    |                |         |
| CW (Clock switch)    |                |         |
| RS (RS relay)        |                |         |

**Chapter III General Description of Function Blocks**

|   |   |   |
|---|---|---|
| CPG (Clock pulse generator)                             |  |    |
| RPR (Hold ON time-delay relay)                          |  |     |
| UCN (Up-counter)  |   |     |
| DCN (Down- counter)                                     |   |    |
| MPLR (Single pulse time relay)                          |   |   |
| TEL (Telephone dialing block)                           |   |  |
| AN (analog input block)                                 |   |  |
| PLAY( Broadcast voice section & Selector switch blocks) |   |   |
| MR (Recording voice section& Selector switch)           |   |   |



3.2.1 DPR

| Line diagram/Symbol inFAB | Pin         | Description  |
|---------------------------|-------------|--|
|                           | input TRG   | After TRG is triggered, the time delay timer starts timing. (If TRG stops triggering during the timing of timer, the timer will terminate the timing). |
|                           | Parameter T | After time T, the output is on (the output signal changes from 0 to 1).  |
|                           | Output Q    | If there is still trigger signal, when time T is up, the output will be on.  |

Time Sequence Frame:

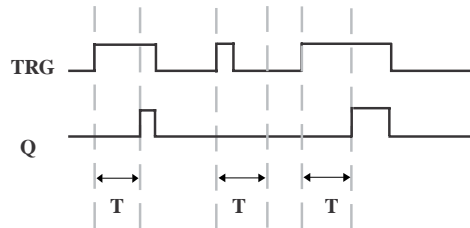

Description:

When the status of TRG input changes from 0 to 1, the time-delay timer starts timing. If Input TRG holds status 1 for a sufficiently long time, the output will be changed to 1 after the time T has elapsed. There is a time delay between the input turning ON and the output turning On, that is why the ON time-delay is so called.

When the input TRG is Status 0, the output will reset to status 0.

This function is applicable to override vibrations of switches, delayed start-up of motor, delayed turning-on of lights, etc.

The assignment range for T is 0.01- 99.99, and the time units can be set respectively to hour (H), minute (M) and second (S). Its time accurately can reach 0.5/00 S.



3.2.2 DDR

| Line diagram/Symbol inFAB | Pin         | Description   |
|---------------------------|-------------|---|
|                           | Input TRG   | Turn on the time of the time-delay off relay ,when the input TRG (trigger) is at the descending edge (changing from 1 to 0)         |
|                           | Input R     | The timer of disconnecting time-delay relay is reset via R (Reset Input), and Output Q is set to 0. (R has higher priority to TRG). |
|                           | Parameter T | The output is disconnected (the Q status is changed from 1 to 0) when the time T elapses .  |
|                           | Output Q    | Input TRG is activated then the output is turned on (Q=1) and is kept ON until it is reset when the set time T is up.               |

Time Sequence Frame:

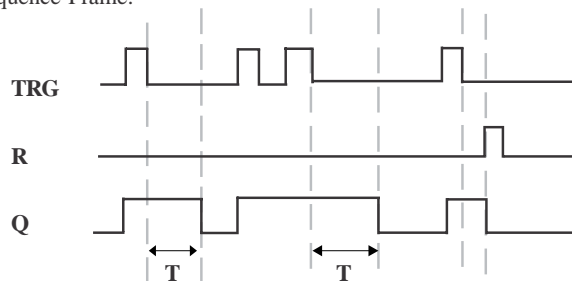

Description :

When Input TRG is Status 1, Output Q is changed at once to Status 1. When Input TRG is changed from 1 to 0 (when the descending edge comes), the internal time delay timer of FAB is activated and Output Q is still remained in Status 1. When the set time T is up, Output Q becomes 0 and the timer is reset 1. If Input TRG changes from Status 1 to Status 0 again, the timer is activated again. Before the set time T is up, the timer and output can be reset via R (Reset) input.



This function is applicable to the lighting of staircase, the control of barriers in a car park, the control of a water throttling valve, etc.

The assignment range of T is 0.01 ~ 99.99, and the time units can be set respectively to hour (H), minute (M) and second (S). Its time accuracy can reach 0.5% S.

### 3.2.3 PLR

| Line diagram/Symbol inFAB | Pin       | Description   |
|---------------------------|-----------|---|
|                           | Input TRG | Trigger input (TRG) makes the output On and Off   |
|                           | Input R   | The output Q is reset via R (Reset input) (Q=0, R has a higher priority to TRG).                                    |
|                           | Output Q  | Every time TRG changes from 0 to 1, the status of Q will be changed (i.e. from Status 0 to Status 1 or vice versa). |

Time Sequence Frame:

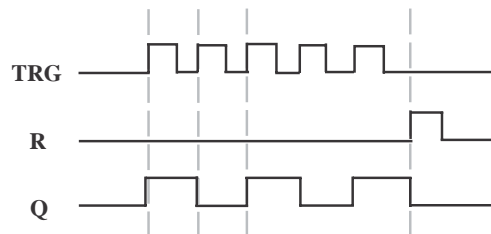

Description :

Every time the trigger input TRG changes from status 0 to Status 1, the status of Output Q will change accordingly (The status of Q will be reversed).

Reset Q to Status 0 via Input R.

After the power is ON or OFF, the pulse relay is reset and Output Q changes to 0.

## Chapter III General Description of Function Blocks



This function can be applied to the lighting of corridors and staircases, and the start/stop of motor with a single push-button, etc.

### 3.2.4 CW

FAB has clock switches for 127 time intervals.

| Live diagram/symbol | Pin              | Description  |
|---------------------|------------------|--|
|                     | ON/OFF           | Set the switch time of the output. Output switch time setting. ON (T1) is the time setting for output to begin turning on. OFF (T1) is the time setting for output to begin turning off. |
|                     | Parameter<br>D/W | Options of date system of week system. D for the date system and W is for the week system.   |
|                     | Output Q         | If one of the parameterized time intervals is ON, the output is ON.  |

Notes regarding the time sw:

1. When the date system is selected for the timing of a time switch.

For the same output channel, up to 127 time switches can be set, and these switches must be put in order according to the time sequence, e.g.

|                           |   |    |
|---------------------------|---|----|
| On: May 1st, 2000 9:00    | } | Q1 |
| Off: May 2nd, 2000 8:00   |   |    |
| On: Aug 2nd, 2000 10:00   |   |    |
| Off: Aug. 2nd, 2000 19:00 |   |    |

The above arrangement is correct, while the below arrangement is wrong:

|                          |   |    |
|--------------------------|---|----|
| On: May 1st, 2000 19:00  | } | Q2 |
| Off: May 1st, 2000 18:00 |   |    |
| On: Apr 2nd, 2000 8:00   |   |    |
| Off: Apr. 2nd, 2000 5:00 |   |    |

## FAB Intelligent Control

---



During the time setting of the time switch, if two time-points (on and off), are set the output is on in the time interval before the time, the output maintains the former status, and after the off time the output is off.

### 2. The range of T1 and T2

You can set T1, T2 anytime from 00:00:00 to 23:59:59. If you set T1 or T2 at 24:00:00, it means that you have not set the ON time or OFF time. (If you set T1 to 24:00:00, it means that you haven't set ON time).

On the basis of this, we can set some special time intervals which haven't been set in the selected items by using Inter-relays and Logic interlock. Such as that there is no item of the following.

6:00 on Monday ,ON and 8:00 on Tuesday, OFF

How can we get the logic result of the above on the FAB panel?

Firstly: you should select MO ,and set it as follows.

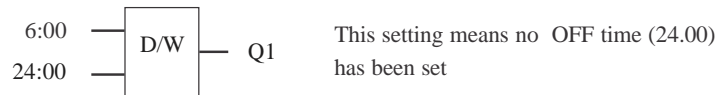

Secondly: you should select TU, and set it as following.

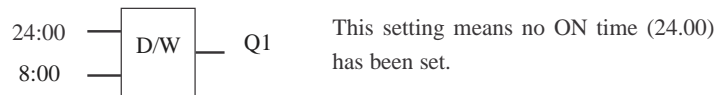

Then, it can let Q1 switch on at 6:00 on Monday and switch off at 8:00 on Tuesday.



**Note:** You can set time directly as follows when you use QuickII Software.

ON MO :6:00  
OFF TU :8:00

## Chapter III General Description of Function Blocks



In the time setting for the time switches, if 2 time setting points for ON/OFF are set, the output is ON status only in this time interval, and the output keeps the original status when it is before the ON time, and the output is OFF status when it is after the OFF time.

It can directly be changed into the above logic from a computer and transmitted to FAB and is inaccessible to the user

3. If only ON time or OFF time is set, the changes of output status are as follows:

| Setting condition | Time                               | Output status               |
|-------------------|------------------------------------|-----------------------------|
| only ON time      | Below ON time                      | Keeping the original status |
|                   | Greater than and equal to ON time  | ON status                   |
| only OFF time     | Below OFF time                     | Keeping the original status |
|                   | Greater than and equal to OFF time | OFF status                  |

4. When the week system is selected for the timing of time switches:

The interval from Monday to Sunday is defined as a circle (MO is the start point, and SU is the end point). In one time interval, it is not allowed to set the start point after the end point. It is OK to flow the Sequence of MO, TU, WE, TH, FR, SA, SU,

The following definition should be noted.

For example,    ON :        5:00    every Sunday  
                         OFF:        8:00    every Monday

## FAB Intelligent Control

---



It can be programmed by three blocks as follows:

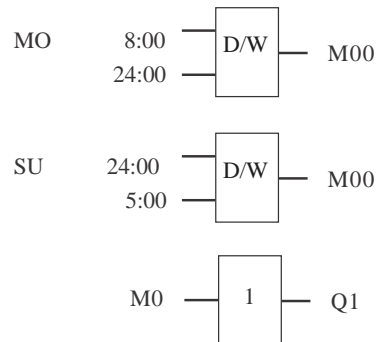

### Notes:

*MO*: Monday

*TU*: Tuesday

*WE*: Wednesday

*TH*: Thursday

*FR*: Friday

*SA*: Saturday

*SU*: Sunday

*MO-SU*: every day from Monday to Sunday

*MO-TH*: every day from Monday to Thursday

*MO-FR*: every day from Monday to Friday

*MO-SA*: every day from Monday to Saturday

*FR-SU*: every day from Friday to Saturday

*SA-SU*: every day from Saturday to Sunday

As for the case that OFF time is set without ON time, e.g. it is set to be OFF at 5:00 from Monday to Thursday, and FAB can turn OFF the output after 5:00 everyday from MO ~ TH, as to when it is going to be ON, it depends on other factors (the original status will be maintained for Friday, Saturday and Sunday).

5. Whether the date system or the week system is selected, the time intervals for the time of the same date should be arranged in chronological order, for example:

### Chapter III General Description of Function Blocks

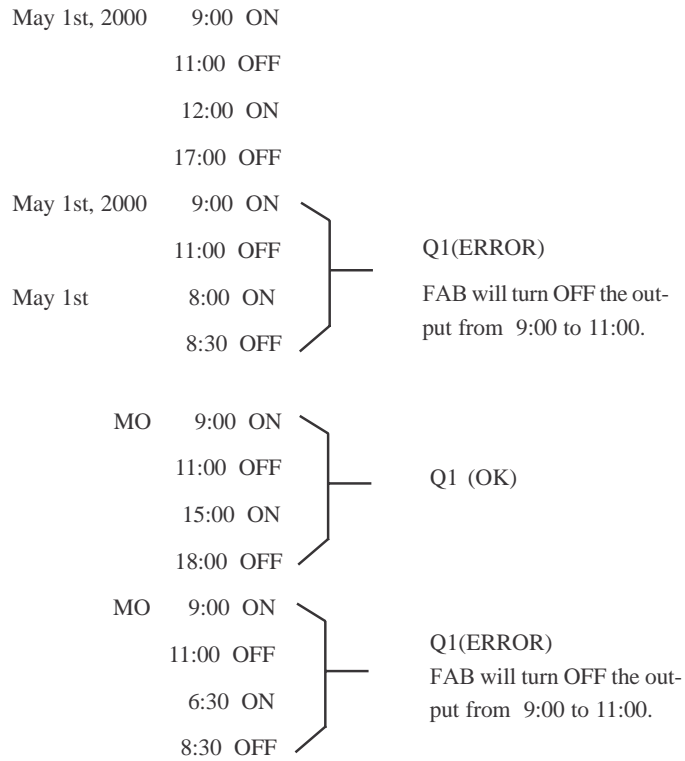

*Note: this phenomenon follows the principle of the later command surpassing the former command.*

## FAB Intelligent Control

---



6. When the week system is selected, if ON is set at 8:00 and Off is set at 9:00 of MO~ TH, FR, HP2 and SU will maintain the former status the D selection will be neglected by FAB i.e., the original ON status will be kept as ON and the original OFF status will be kept as OFF.

7. When you program by using the LCD panel, having selected Week system, it is only necessary to set T1 and T2, and it is meaningless to set D . It is necessary to set D when you have selected Day system. D is the setting of data, T1 is the setting of ON time, and T2 is the setting of OFF time.

### 8. Clock hold circuit

For FAB, when there is a power failure or a power is cut off, the internal clock will continue to run. The time that FAB can maintain the internal clock to run depends on the temperature, when the temperature of the FAB is 25 degrees C, the clock can continue normal operation for more than 100 hours.

### 9. Conflict between time intervals

When using the time intervals to set the ON/OFF time for the clock, the clock switch will make the output ON at the ON time unless it has already been ON, and the clock switch will make the output OFF at the OFF time unless it has already been OFF.

### 10. Accuracy of RT clock

The accuracy of RT clock can reach 1s. A requirement with a duration less than one minute can be done by using one function block in FAB. This function is applicable to the control related to time, e.g. ringing bell for classes in school, work in factories, timed start-up and shutdown of machines, etc.



3.2.5 RS

| Line diagram/Symbol in FAB | Pin      | Description  |
|----------------------------|----------|--|
|                            | Input S  | Set Output Q to 1 via Input S (Set). S port can receive two-tone signal input such as P0~P9 phone signals.                   |
|                            | Input R  | Set Output Q to 0 via Input R (Reset). If S and R are 1 at the same time, the Output Q is 0 (with R having a priority to s). |
|                            | Output Q | When S is input, Q is ON and held ON, and will not be reset until Input R is set.  |

Switch characteristics

RS relay is a simple trigger. The output value depends on the input status and the original output status. The following list of true values is used to describe the logic relations:

| S | R | Q | REMARK                              |
|---|---|---|-------------------------------------|
| 0 | 0 |   | Status remain to the original value |
| 0 | 1 | 0 | Reset                               |
| 1 | 0 | 1 | Set                                 |
| 1 | 1 | 0 | Reset (having a priority to Set)    |



**Note:** P0-P9 represent the 0-9 buttons of the telephone. RS function block has the function to receive a two-tone signal. You can use the RS function block to receive telephone signal and control the external equipment.



3.2.6 CPG

| Line diagram/ Symbol in FAB | Pin         | Description  |
|-----------------------------|-------------|--|
|                             | Input EN    | Make clock pulse generator ON and OFF via Input EN (Enable).   |
|                             | Input R     | Make Output Q be 0 via Input R (Reset).  |
|                             | Parameter T | T is the time length of output to be ON and OFF.   |
|                             | Output Q    | Every time EN changes from 0 to 1, the internal timer begins to time, and when Time T is up, the output is 1. If EN is held on 1, timing can be started again, and when Time T is up again, the output is 0. The cycle operation is continued in this way until EN is 0 and Output Q is 0. When R is 1, then the output Q is 0. And when R changes from 1 to 0 and EN is 1, all the initial status of Q changing from 0 to 1 will start its cycling changed. |

Time sequence frame is as follows:

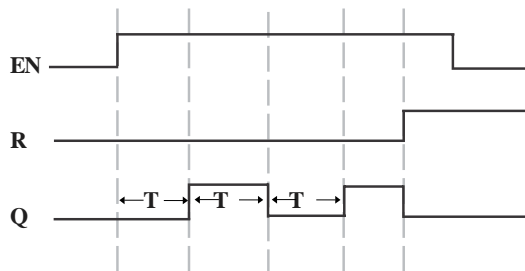



**Notes:**

Use Parameter *T* to set ON/OFF time. The assignment range of *T* is 0.01 ~ 99.99, and the time units can be set respectively to hour (H), minute (M) and second (S). The time accuracy can reach 0.5 Second.

Input *EN* ( Enable) enables the clock pulse generator to work. Output *Q* of clock pulse generator will flip-flop the status every time the time *T* elapses, and cycle operation is continued in this way until Input *EN* (Enable) is 0. The clock pulse generator then stops operation and Output *Q* is 0.

This function is applicable to generated pulse automatically and to switch ON/OFF automatically.

**3.2.7 RPR**

| Line diagram / Symbol in FAB         | Pin         | Description  |
|--------------------------------------|-------------|--|
| <p style="text-align: center;">↓</p> | Input TRG   | Timer for ON time delay is started via Input TRG (Trigger).  |
|                                      | Input R     | Timer for ON time delay is reset to ON via Input R, and make Output Q is 0 (The priority of R is higher than that of TRG). |
|                                      | Parameter T | After TRG is triggered and the time T elapses, the output is ON.   |
|                                      | Output Q    | After time delay T elapses, the output is ON.  |

## FAB Intelligent Control

---



Time Sequence Frame:

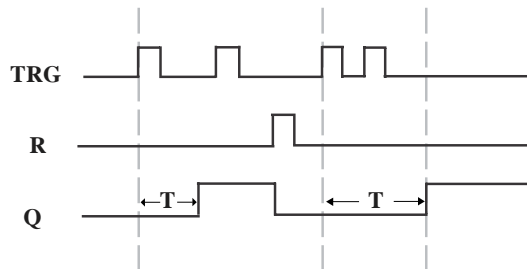

### Notes:

*If the status of Input TRG changes from 0 to 1, the internal timer will be activated. When time T is up, Output Q becomes 1 and then the input TRG coming again has no effect on output Q. Only when Input R becomes 1 again Output Q and Timer T will be reset to 0.*

*This function is applicable to the locations where the time-delay ON and hold ON status are required.*

*The assignment range for T is 0.01 - 99.99, and the time units can be set respectively to hour (H), minute (M) and second (S). Its time accuracy can reach*

*0.5 /00 second.*



3.2.8 UCN

| Line diagram/symbol in FAB | Pin           | Description   |
|----------------------------|---------------|---|
|                            | R             | Input R has priority to other input, When it inputs resetting signal, the counter is reset to 0 and cut put Q is reset simultaneously   |
|                            | Input CNT     | When CNT counting is input, the counter only counts the leading edge triggering (the status changes from 0 to 1), i.e. every time the leading edge is triggering, the counter will increase by 1. |
|                            | Parameter PAR | When the internal counting value is greater or equal to Parameter PAR, Output Q is 1 The assignment of counter is 0 ~ 999999.   |
|                            | Output Q      | When the counting value has been reached, Output Q is On.   |

Time Sequence Frame:

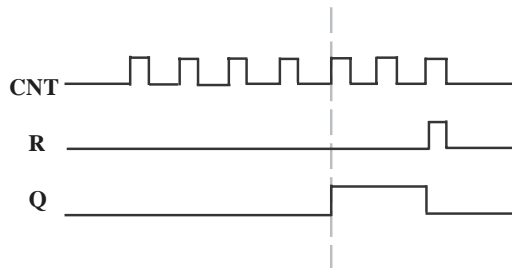

*Note: This function is applicable to the locations where counting is required.*



3.2.9 DCN

| Line diagram/Symbol in FAB | Pin           | Description  |
|----------------------------|---------------|--|
|                            | Input R       | R has a priority to other input, when R inputs reset signal, the counter is reset to 0 and output Q rests simultaneously.  |
|                            | Input CNT     | When CNT counting is input, the counter will only count the front edge triggering (the status changes from 0 to 1), i.e. every time the leading edge is triggering, the counter is decreased by 1. |
|                            | Parameter PAR | When the internal parameter is decreased to 0, Output Q is 1. The assignment of counter is 0 ~ 999999.   |
|                            | Output Q      | When the counting value is 0, Output Q is On.  |

*Note: This function is applicable to the locations where the counting is required.*

3.2.10 MPLR (Single-pulse time relay)

| Line diagram/Symbol in FAB | Pin         | Description  |
|----------------------------|-------------|--|
|                            | Input TRG   | Trigger the input to activate the single-pulse time relay. When the leading edge of TRG comes, a pulse with a duration of T is output. |
|                            | Input R     | Reset the single-pulse time relay. When R is 1, Output Q becomes 0.  |
|                            | Parameter T | The assignment of the pulse duration setting is 0.01 ~ 99.99 (second, minute, hour). The time accuracy can reach 0.5 second.           |
|                            | Output Q    | Every time TRG changes from 0 to 1, Q outputs a pulse with a duration of T.  |



Time Sequence Frame:

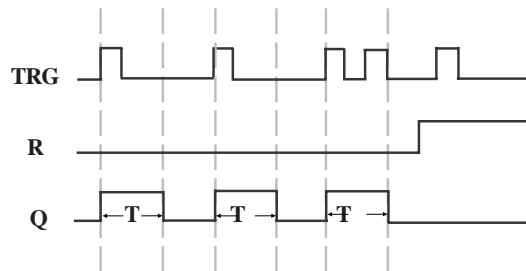

**Notes:**

When Q is 1, TRG pulse will have no effect on Output Q.

This function is applicable to the locations where the pulse duration is required to be increased.

**3.2.11 Tel** (The FAB-MUL to be used in conjunction with FAB)

| Figure | Pin    | Description   |
|--------|--------|---|
|        | Input  | The input port is selected as follows: I1 ~ IC, Q1 ~ Q8, HI, LO, M00 ~ M126, P0 ~ P9.   |
|        | Output | When output is 1, the telephone number of output port will be dialed to output. If the input has been 1 all the time, dialing will be kept on, once every 30 seconds and when the input is 0, dialing stops. The option range of output port will not exceed 25-digit telephone number. |

## FAB Intelligent Control

---



### Note:

The function of telephone blocks are mainly dialing, output, alarm, etc. This block is used together with the locking-up relay (RS relay) function block. It can be used to not only receive the coming call signals to control the terminal equipment, but also dial to output the alarm under certain conditions. Presentation on how to implement it is made as follows:

a. The basic circuit for controlling periphery devices by incoming call is shown as the following diagram:



This control requires the presetting of the telephone two-tone signal (P0 ~ P9) to drive RS relay during the programming of FAB, the periphery devices is driven by the output of RS relay, so when FAB receives P0 ~ P9 signals of an incoming call, it is possible to control the peripheral devices.

Step 1: Use the external telephone to dial the telephone number of the telephones connected to FAB, connecting FAB then there appears the voice prompt: please enter the password.

Step 2: Enter the password of the FAB correctly, and there appears the voice prompt: please enter the information code.

Step 3: Dial P0 - P9 control signals to control the output of FAB. RS block input has telephone two-tone pulse signals P0 - P9, during programming, the input of RS needs to be set to P0 - P9, so as to implement the control function of the telephone function block.

When I1 is ON and I2 is OFF again, the second section can then be input. (It is called accumulated input).

This function should be applied to the locations where the voice prompt is required. It is necessary to first make a recording.



b. Telephone alarm: When the input signal of this function block is 1, start to dial automatically the preset number.

After the telephone lines and power supply lines of FAB and FAB-MUL are connected, dial the number of the telephone that is connected with FAB. When you have got through, you will hear: please input password. Now input the password for programming through the telephone number keyboard and please do not forget to start with \*. When the password has been properly input, please input \* and 0, you will hear the prompt voice: electrical appliance is switched on. Relay Q1 will be on at the same time. If \* and 9 are input, you will hear: electrical appliance is switched off. Relay Q1 will be off. The prompt voices for switch-on and switch-off will continue for 5 seconds.

This feature is used in locations where both automatic dialing and automatic alarm are required. FAB matched with AF-MUL, will achieve telephone control and voice function. Please refer to chapter 6 .

When you program the CW clock on the LCD panel, you should add : at the end of the telephone number, this marks of the end of the telephone number .

**3.2.12 PLAY** (The AF-MUL to be used in conjunction with FAB)

| Figure of FAB | Pin | Description   |
|---------------|-----|---|
|               | On  | When ON is 1, Output Q is 1, i.e. the voice section is turned on for broadcasting. The options range for its input is I1 ~ IC, Q1 ~ Q8, HI, LO, M00~M126,X. |
|               | OFF | When OFF is 1, Output Q is 0, i.e. the voice section is turned off. The option range of its input is I1 ~ I12, Q1 ~ Q8, HI, LO, M00~M126, X.                |
|               | Q   | The option range of output is 04~ 98, and there are 98 voice sections in total.   |

This function is applied to the locations where the voice prompt is required

## FAB Intelligent Control



### 3.2.13 MR (The AF-MUL to be used in conjunction with FAB)

| Figure of FAB | Pin | Description  |
|---------------|-----|--|
|               | ON  | When ON is 1, record the voice sections. The option range of the input is I1 - IC, Q1 - Q8, HI, LO, M00~M126, X.   |
|               | OFF | When OFF is 1, recording is completed, turn off the switch for recording voice sections. The option range of this input is I1 ~ IC, Q1 ~ Q8, HI, LO, M00~M126, X.  |
|               | Q   | The options for the output port are 01 ~ 09. Please note that: when the output is selected as 99, it does not represent to record the 99th voice section but that to clear all the voice sections, therefore, care should be taken for using . |



#### Notes:

Please refer to chapter 6 to learn how to record your voice.

When making a recording, the recording should be performed in an order of 01 - 98 and the process should not be interrupted, that is to say, it is not allowed to record the third section after the first section is recorded. (If the same block is used, the sections can be accumulated automatically as long as the conditions change) e.g. I1 - ON, I2 - OFF and Q=01, the first section is input at the beginning when I1 is ON and I2 is OFF. When I1 is Off and I2 is ON, the first section is turned off.



3.2.14 COMP

| Figure in FAB | pin      | notes in FAB  |
|---------------|----------|---|
|               | Input 1  | comparative input port 1, with 0.0~10.0, I1~IC to be selected.  |
|               | Input 2  | Function selection <=,>=,>,<=,=   |
|               | Input 3  | comparative input port 2, with 0.0~10.0, I1~IC to be selected.  |
|               | Output Q | with conditions available, output Q is 1 and its selection range is Q1~Q8, M00~M126. Remarks: It may be compared with <=,>=,<,>=,=. |

**Notes:**

Only AF-10DMR, AF-10DMT, AF-20DMR, AF-20DMT types have this function.

This function is used in the input function block for analog quantity.

Operation of AN function block

The comparison function of AN block is comparison between input 1 and input 3. Such as when you select input 2 as >, it means that when input 1 > input 3, Q will be 1. When input 1 < input 3, Q will be 0.

Example 1 : Input 1 = I1    Input 3 = 050    Input 2 = >, Q = Q1

If I1 > 5.0V, then Q1 will be ON

If I1 < 5.0V, then Q1 will be OFF

Example 2: Input 1 = I1    Input 3 = I2    Input 2 = <, Output = Q2

If I1 < I2, then Q2 will be ON

If I1 > I2, then Q2 will be OFF.

**FAB Intelligent Control**



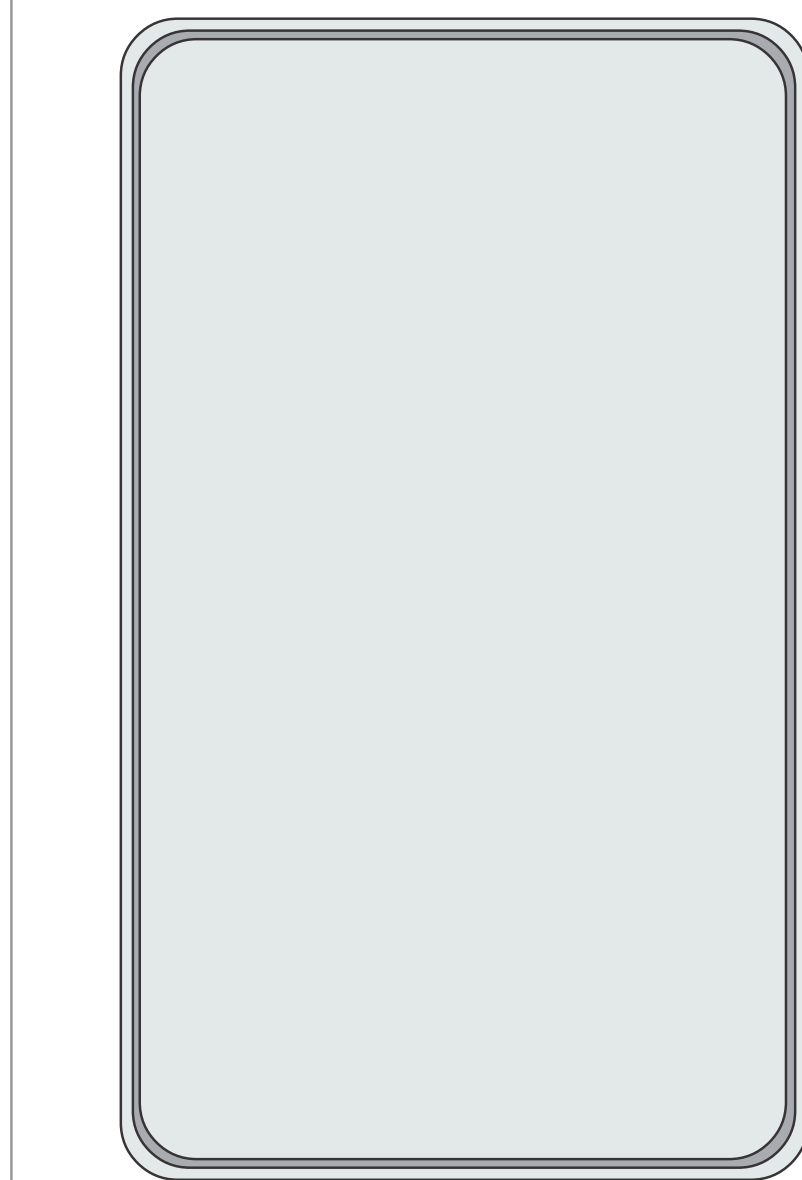





---









### Chapter IV Programming operation on FAB panel

There are two methods of programming for FAB, one is to complete editing of the function diagram directly on the operation LCD panel using the keys, while the other is to do the same on the computer using the programming software QUICK II . The latter procedure is recommended for more complex control schemes. Programming for FAB can be completed with either of the two methods. This Chapter will describe in detail how to use the operation LCD panel to edit the Function Block Diagram Program and the programming method using QUICK II will be covered in detail in the second part of this manual.

As shown in the following figure, the operation LCD board is a simple man-machine interface and the program editing operation will be completed through the 8 keys on the right: , , , , , , , .

The following rules shall be observed for programming operation on this panel:

1. When the cursor appears as an under line, it may be moved:

Move the cursor along the lines with , ,  and  keys;

Press the OK key to confirm selection of the input/output connection or the function block;

Press ESC key to exit the programming input.

2. When the cursor appears as >, the input/output or function block may be selected:

Select the input/output or function block with  and  keys;

Press OK key to confirm the selection;

Press ESC key to return to the previous step.

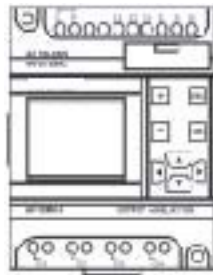

Fig. 4.1

#### 4.1 Display status of FAB

Connect FAB (Fig. 4.1) to the power supply with the method as described in Chapter II. After the power supply is switched on, the LCD panel displays a frame (Fig. 4.2), which is the Status Display Frame:

the upper line I contains the status values of inputs 1 ~ 6

the lower line Q contains the status values of outputs 1 ~ 4

(in which \* indicates ON, i.e. status 1, □ indicates OFF, i.e. status 0.)

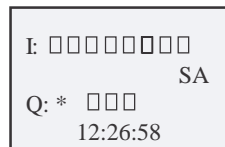



Fig. 4.2 Status Display Frame

#### 4.2 Confirm password

Pressing ESC and OK simultaneously at the Status Display Frame as shown in Fig. 4.2, the user can enter the Confirm Password Frame, as shown in Fig. 4.4. Now it is necessary to input the password value for FAB. The cursor stays at the highest digit of the password, where you can change the digit value (0~9) with the **−** and **+** keys (when you initially press **−** or **+** key, the password value is 0).



Then you can use the  and  keys to change the password input position and input the password values of the remaining digits . If a proper password has been input, you will enter the Editing Frame shown in Fig4.4. If the password is incorrectly input twice consecutively, the Status Display Frame, as shown in Fig. 4.2, will be presented.



*Note: The ex-works password is 0001.*

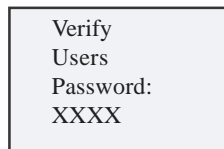



Fig. 4.3 Confirm Password Frame

### 4.3 Function

Entering the editing frame shown in Fig4.4, the user may use  and  keys to move the arrow > on the left and press the OK key to select the functions, with the following 4 options for selection:

Editor: edit program; Editing Function Selecting Frame shown in Fig. 4.5 will be on when this function is selected;

FAB/Rom: read program, modify the address and reset the modem, etc. the frame shown in Fig 4.19 will be on when this function is selected.

Set: setup RTC real time clock and setup password;

RUN: start running FAB program.

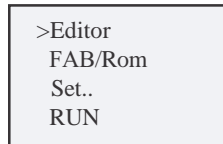

Fig 4.4



### 4.3.1 Editor

When this function key is selected, FAB will enter the Editing Function Selecting Frame as shown in Fig. 4.5. The user may use ▲ and ▼ keys to move the arrow > on the left and press OK to select the functions.

Edit PRG: Input a function block (consult 4.2.1.1);

Insert FB: Insert a function block into the existing program (consult 4.2.1.2);

Delete FB: Delete a function block from the existing program (consult 4.2.1.3);

Clear PRG: Delete all program block.

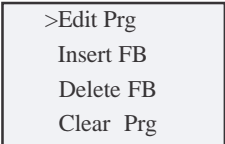

Fig. 4.5 Editing-function Selecting Frame

#### 4.3.1.1 Edit PRG

The Edit PRG Menu Frame is as shown in Fig. 4.6 and the function blocks are to be selected under this menu.

Select Function Blocks:

The user may use the ▲ and ▼ keys to move the arrow > on the left to select the function blocks. Press OK to select a function block, the Function Block Setting Frame shown in Fig. 4.7 will be on (please refer to Chapter III Specification of function Blocks). This menu includes the following function blocks: AND, NAND, OR, NOR, XOR, NOT, RS, UCN, DCN, PLR, MPLR, CPG, RPR, DPR, DDR, CW, TEL, PLAY, MR, ANALOG (D type).

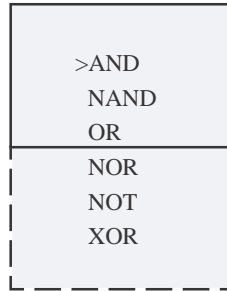

Fig. 4.6 Function-Selecting Frame

Set Function Block:

When the Input Function Block is selected, FAB will automatically help you to define in sequence the numbers of the blocks beginning with B and display the said numbers in the bottom right corner (e.g. B01), as shown in Fig. 4.7.

The user may select the input/output and parameter values to be set up for the function block by moving , , , keys (please refer to Chapter III Specification of Function Block for the input/output/parameter values for different function blocks).

When Selection Output/Input Link is set, press OK to enter the Parameter Setting Status. The user may use , keys to select the connection point type and for the said output/input, as shown in the top left corner of Fig. 4.7. First move the cursor to I in the top left corner with , keys, change the type of the connection point with and keys and press OK to confirm it. Then increase or decrease the operand for the connection point with and keys (e.g. I0, I1, I2, etc.).

*Note: The operands for different types of connection points have different ranges. It is I1 ~ I6 (10 point type) or I1~IC (20 point type) for I (input) and Q1 ~ Q4 (10 point type) or Q1~Q8 (20-point type) for Q (output). Operands are not required for H (high), L (low) and X (empty). M means intermediate relays M00 ~ M99.*

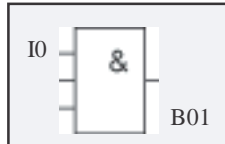

**Fig. 4.7 Setting the parameter of function blocks**

Described above is the set up of basic function blocks. It is also necessary to explain the setup of the operands for some special function blocks in the following.

1. Function blocks with timing function

Function blocks with timers include:

- |                                    |                            |
|------------------------------------|----------------------------|
| DPR: Delay putting Relay           | CPG: Clock Pulse Generator |
| DDR: Delay Disconnection Relay     | RPR: Retentive On Relay    |
| MPLR: Mono-pulse Relay Pulse Relay | CW: Clock Switch           |
| PLR: Pulse Relay                   |                            |

When parameter T is set, the following frame will be on the LCD panel

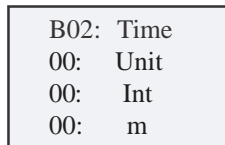

**Fig. 4.8**

- The line 1: Block number and timing mark
- The line 2: time units— HOU (Hour) , MIN (Minute), SEC (second)
- The line 3: Setting whole number of time (00-99)
- The line 4: Setting decimal of time (00-99)



2. Function blocks with counting function include:

UCN: Up Counter

DCN: Down Counter.

When the PAR is set, the following frame will be on the LCD:

|            |
|------------|
| B01: Count |
| 00: D1     |
| 00: D2     |
| 00: D3     |





Fig. 4.9

The 1st line represents the block number and counter mark

The 2nd line represents the highest digit of the counting value

The 3rd line represents the second-highest digit

The 4th line represents the lowest digit.

You may set the parameters in turn, as required, by pressing  and  to move the cursor and select the parameters and pressing  and  to change the value.

For example, for setting a number as 967843. D1=96,D2=78,D3=43.

3. Set parameters for the Clock Switch

1) As the date system D is selected, the following will be (displayed) on LCD:

|              |
|--------------|
| Day          |
| D 2000,00,00 |
| T1 000000    |
| T2 000000    |

Fig. 4.10



The 1st line represents the date system

The 2nd line represents year, month and day

The 3rd line represents the output ON time (T1).

The 4th line represents the output OFF time (T1).

2) As the week system W is selected, the following will be on the LCD panel:

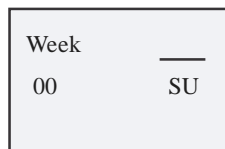

**Fig. 4.11**

At this time , you can use **+** , **-** keys to select the type of weeks.

MO represents Monday

TU represents Tuesday

WE represents Wednesday

TH represents Thursday

FR represents Friday

SA represents Saturday

SU represents Sunday

MO-TH represents Monday to Thursday

MO-FR represents Monday to Friday

MO-SA represents Monday to Saturday

MO-SU represents Monday to Sunday

FR-SU represents Friday to Sunday

SA-SU represents Saturday to Sunday.



After selecting the week system press the ESC key, you will then be able to select the timing and the following will be displayed on LCD:

|      |            |
|------|------------|
| Week |            |
| D    | 2000,00,00 |
| T1   | 000000     |
| T2   | 000000     |

**Fig. 4.12**

The first line represents the week system

The second line represents year, month and day

The third line represents the output-ON time

The forth line represents the output-OFF time.



*Note: You only need set T1, T2, and need not set D when you select the week system the set data will be neglected by the system*

#### 4. Set the Telephone Block

When the Telephone Block is selected, the following will be displayed on LCD panel. Set the input on the left of the block first, move the cursor to the output on the right and press OK.



**Fig. 4.13**



After OK key is pressed, the following will be on the LCD panel:

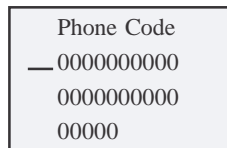

Fig. 4.14

Press , , , keys to move the cursor and select the digits of the telephone up to a 25-digit number and press , to change the value and set each digit of the telephone number in turn. After the number is set, move the cursor to the last digit of the set number and press to exit .



*when you complete setting the telephone number, you must add : marking the end of the number.*

**5. Set the AN block**

AN block is as follows

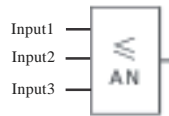

Input 1: I and K are available input.

(1) That the I is selected, it represents this port is connected to FABs -input, whose range is I1~I6 (AF-10 series), and I1~IC (AF-20 series). The operation on the LCD panel is the same as general I. That K is selected represents that digital value, whose range is 000~100 which represents voltage 0~10.0V. The first two digits represent integer , the last digit represent the decimal part.



(2) When input 1 is K or I, press OK to confirm and then to press **+** and **-** to change the digital value. Finally press OK to confirm.

Input 2: It represent s function selection, There are 5 comparison functions which can be selected >,<, <=,>=,= Select by using **▲**, **▼** and then press OK to confirm.

Input 3: It is the same as Input 1.

### 4.3.1.2 Insert FB

This function can be used to insert a function block into a scheduled block position. The operating process is as follows:

1. Press OK at >Insert FB in the Editor Frame, thus the inserting status is entered, as shown in Fig. 4.15.

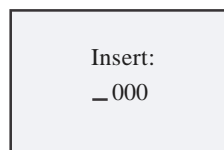

**Fig. 4.15 Insert Function Block**

2. 000 shown in the above frame is the original value, Press **+** or **-** to select the block number and then press OK to confirm. The range of inserted block numbers is from 001 to the maximum number of the current program. If the selected number is not in this range, pressing OK will not be effective and it will return to the original status to let you select a block number in a suitable range. If you want to give up inserting a block, please press **ESC** to exit. If you are not clear about the maximum number in the program, you can use ROM-FAB in FAB/ROM to read the program and get the number.

3. If you select a right number in the above step and press OK to confirm the number, then machine will affect your operation and function block codes (eg. AND, OR, NOT, RS, TEL,...etc.) will appear for your selection.



*Note: If you do not go on selecting but exit, FAB will copy a function block the same block number as the old one. But if you are in the editing step, you can exit only when you finish setting all of the terminals as. You can then delete the block by using Delete FB.*

#### 4.3.1.3 Delete FB

This function can be used to delete any function block. The operating process is as follows:

1. Press OK at >Delete FB in the Editor Frame, thus the deleting status is entered, as shown in Fig. 4.16.

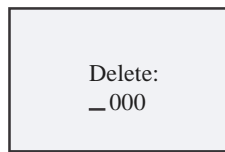

**Fig. 4.16 Delete Function Block**

2. 000 shown in the above frame is the original value. Press **+** and **-** to select the block No. and then press OK. The range of block number for Delete FB is from 001 to the maximum number of the current program. If the selected number is not in this range, pressing OK will not be effective and it will return to the original status to let you select a block number in a suitable range. If you want to discontinue the deleting operation, please press **ESC** to exit. If you are not clear about the maximum number in the program you can use FAB-ROM in FAB/Rom to read the program and get the number.

3. If you have select a correct block number , press OK, FAB will display as follows. It means the selected block has been deleted.

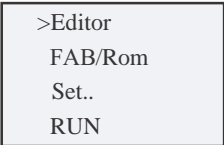

4.3.1.4 Clear Prg

This function can be used to delete all of the existing programs in FAB.

1. In the EDIT frame, Select >clear Prg and press OK, then the following frame will appear .

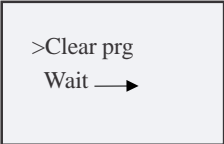

Fig. 4.18 Clear Prg

1. The above frame will last 2~3 seconds, then it will be automatically be on function block selection frame. The old program will have been cleared and you can program again

4.3.2 FAB/Rom

There are three options in Select FAB/Rom Frame, as shown in Fig. 4.17.

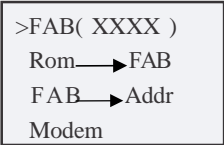

Fig. 4.19



FAB (XXXX): (The series No. of FAB system service)

Rom→ FAB: read the program from FAB

FAB-Addr: view or modify FAB address

MODEM: initialize MODEM.

**4.3.2.1 Read program from FAB (Rom>FAB)**

1. Select Rom→FAB in FAB/ROM, and press OK, the follow frame will appear.

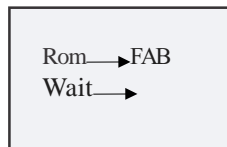
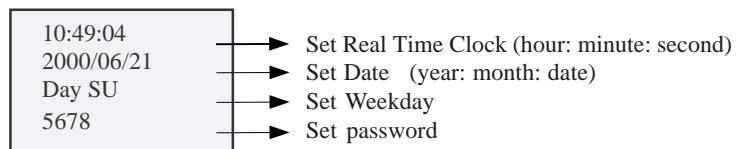

**Fig. 4.20**

2. Press → in the state shown in Fig 4.20, then the program will be read, block by block (in sequence as B01,B02....)

**4.3.3 SET (set password and time)**

The SET Frame is shown in Fig. 4.20. A password and real time clock can be set for the edited FAB function program via this SET Frame. When you want to modify the control function, the said password shall be properly input before the editing modification status can be entered (note: the ex-factory password of FAB is 0001). This function is the password lock function of FAB.



**Fig. 4.21 Set Password Frame**



*Note: If you did not read the FAB's existing program when you edit the program and enter into the editor frame for programming, then it will begin from B01 block. If you want to save the existing program, you should read the program from ROM → FAB and then edit it from editor PRG.*

#### 4.4 Edit FAB function program

During editing of FAB function program, special attention need be paid to Some programming rules, the application of the mid-relays (M) marked, or the FAB circuit diagram shall be drawn directly with QUICK II, and then adjust the series No. of the blocks according to Rule 2 and Rule 3.

##### 4.4.1 Programming rules

**Rule 1:** Before the circuit is input, the complete circuit diagram shall be made on a drawing with the necessary intermediate relays (M) marked, or the FAB circuit diagram shall be drawn directly with QUICK II, and then adjust the series No. of the blocks according to Rule 2 and Rule 3.

**Rule 2:** The input of circuit is always from input to output, with the cause first and result next. The block sequence number of the cause block must be smaller than that of the result block. The block numbers that have no cause relationship with each other are irrelevant.

**Example:**

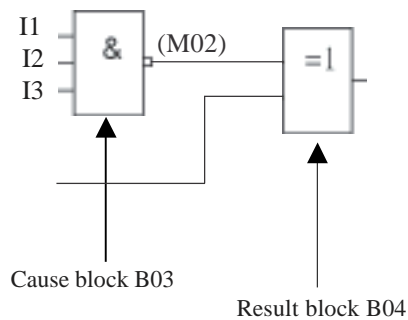

Fig. 4.22



**Rule 3:** In a program path, an output may be connected to the lead input (for number transfer), but the block with a smaller sequence number shall be used as the lead input (cause block) and the one with a greater sequence number shall be the result block. If the user desires for contrary cause and result blocks it is only necessary to adjust the block sequence numbers.

**Rule 4:** One output may be connected to multiple inputs, but multiple outputs cannot be connected to one input.

**Rule 5:** At power-on and initialization of FAB (at the instant of power-on), the intermediate relay (M) and output port (Q) are all in logical 0 status. Their later status will be determined by the program.

**Rule 6:** It is not allowed to connect two outputs with are end. Such as the following

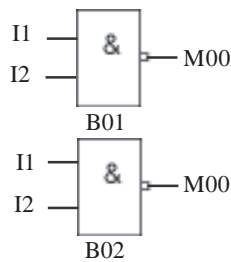

the above is prohibited except for CW block

#### 4.4.2 Middle relay

In FAB programming, the middle is a very important bridge in FAB programming, this is the intermediate relay. The intermediate relay of FAB is similar to that in the relay control system. They can store some intermediate status and then transfer it to a block requiring this status for input. Use of intermediate relays has two advantages:

1. The output terminal of the previous block can be used as the input signal for different blocks;
  2. When a block is inserted or deleted, the original logical relation can be retained.
- The basic functions of the intermediate relay are as shown in the following figure:

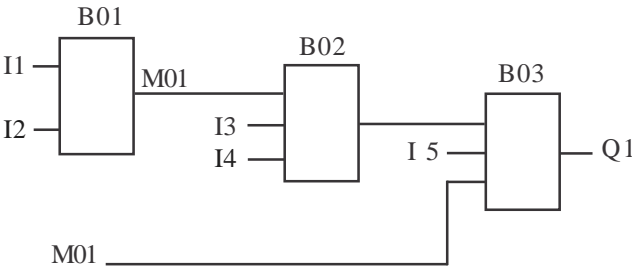

Fig. 4.23

on the above figure, the output status of B01 may not only be used directly as the input of B02 block, but also be stored by M01 and then used as the input of B03.

4.4.3 Edit program

Take the stair lighting system for an example, with the following control requirements: 1. When the switch button is pressed, the light will be turned on and kept normally on; 2. When the sound sensing switch is on, the light will be turned on and kept on for 2 minutes.

The Function Block Diagram for the said control function is as follows:

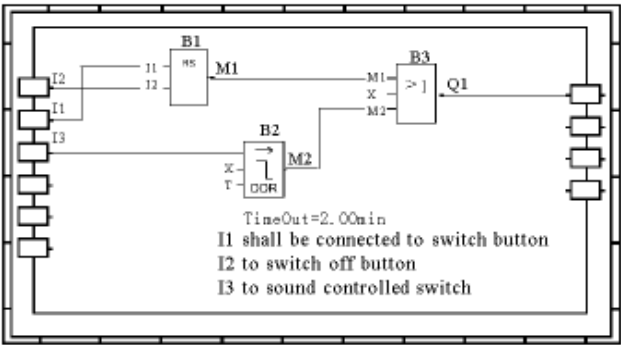

Fig. 4.24



The following procedure shall be followed for editing of the said control function with FAB operation panel:

In case a user program already exists in FAB:

Step I: Enter FAB Editor Frame

1. In 2 ~ 3 seconds after switch-on, the following will be on the LCD panel:

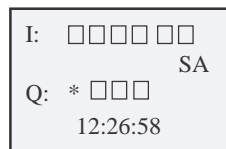

**Fig. 4.25**

2. After **ESC** and **OK** are pressed simultaneously, the Confirm Password Frame is entered. At this time the cursor will stay at the highest digit of the password and the following will be displayed on the LCD panel:

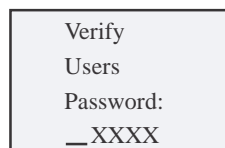

**Fig. 4.26**

3. Input the password, with the password assumed as 2165;

Press **+** twice and the first digit value of the password will change to 2;

press right moving key **▶** and the cursor will move one digit to the right for the second digit of the password value to be input;

press **+** once and the second digit of the password value will become 1;

press **▶** and the cursor will move one digit to the right for the third digit of the password value to be input;



press **+** 6 times and the third digit of the password value will become 6;  
press **▶** and the cursor will move one digit to the right for the last digit of the password value to be inputted;  
press **+** 5 times and the last digit of the password value will become 5.  
After the password is completely input, the following will be displayed on the LCD panel:

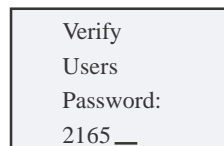

**Fig. 4.27**

4. Press **OK** to enter the Select Editing Function Selection Frame, with the selection mark > staying at Editor function. The following is displayed on the LCD panel:

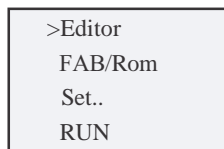

**Fig. 4.28**

Step 2: Edit Function Diagram

1. Press **OK** to select Editor and the Function Block Selection List is entered. The following is displayed on the LCD panel:

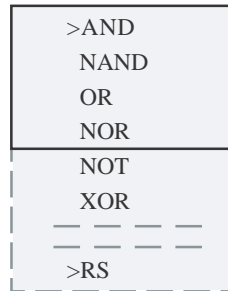

Fig.4.29

2. Select and set the first function block:

Move > to the position of RS relay with and press OK to enter the Function Block Set Status, when the cursor is at the highest input Link. The following will be on LCD panel:

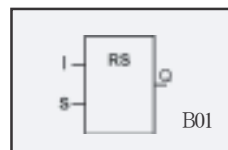

Fig. 4.30

Press and the Set Parameter R link input status will be entered. Now I will appear at R link. If you do not want to select I, you may press to select Q and press it again to select H and may continue with the same until M. It means that the user may select any parameter among I, Q, H, L, C, P and M by pressing . After I is selected, the following will be on the LCD panel:

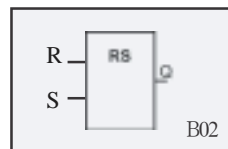

Fig. 4.31



Then it is necessary to set the parameters, namely to set the values with **+**, **-**. For example, if I1 is to be set up, just press **OK** key when I1 is displayed, as shown in Fig. 4.31 (the variation range of I is I1-I6 or I1-IC).

Press **▶** to move the cursor to position S and press **OK** to set the S link input. Selecting I in the parameter list and set it to I2 by the same method as setting I1 and pressing **OK** once. The LCD panel will be as Fig. 4.32.

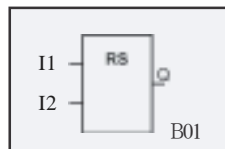

Fig. 4.32

Press **▶** to move the cursor to position Q and press **OK** to set the Q link output. After selecting M in the parameter list and set it to M01 with **+**, **-**, press **OK** again. The following will be displayed on the LCD panel:

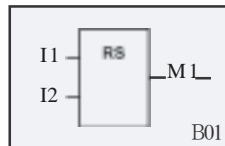

Fig. 4.33

Now, all the three links and edit the following blocks of the RS relay function block are set Then press ESC to exit this block.



**Note:**

*When you enter the edit function block, you cannot exit to the 1-level higher programming interface by pressing ESC or the OK unless you have set all the links of this block (including all the I/O links)*



3. Select and set the second function block

Press **ESC** to return to the Function Block Selection List Frame and select the second function block.

Move > to the position of DDR function block and press **OK**. Now you can set the parameters for the function block. The following will be on the LCD panel:

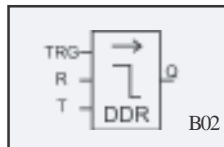

Fig. 4.34

Press **OK** to enter Set Trg Pin Parameter Status. Select I in the parameter list with **▲**, **▼** and press **OK**. Then set Trg to I3 with **+**, **-**. The following will be displayed on the LCD panel:

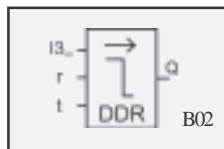

Fig. 4.35

Press **▼** to move the cursor to position R and press **OK** to set the r input parameter. After selecting **OK** in the parameter list, press **OK** to set the parameter X. The following will be displayed on the LCD panel:

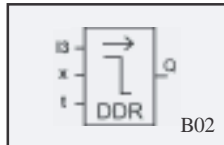

Fig. 4.36

Press **▼** to move the cursor to position T and press **OK** to enter the Set Timer Frame. The following will be displayed on the LCD panel:

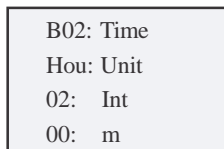

Fig. 4.37

Press **OK** to enter the Time Unit Selection Status. Now the options can be changed with **+**, **-**. When "min in" appears, press **OK** to set the time unit as minute. The following will be displayed on the LCD panel:

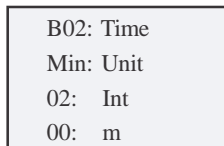

Fig. 4.38

Press **▼** to set the time integer digit and use **+**, **-** to change the value. Set it as 02.

Press **▼** to set the time decimal digit and use **+**, **-** to change the value. Set it as 00. Now the time is set to 2 minutes. Press and then press ESC to exit.



Press **▶** to move the cursor to position Q, press **OK**. Set Q as M02 and then press **OK** again. The following will be on the LCD panel:

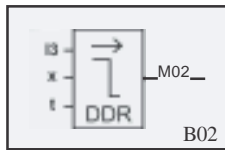

Fig. 4.39

Select and setup the third function block

Press **ESC** to return to the Function Block Selection List Frame and select the third function block.

Move **>** to the position of OR function block and press **OK**. Now you can set the parameters for the third function block. The following will be displayed on the LCD panel:

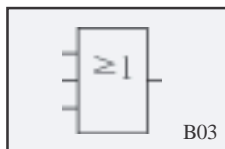

Fig. 4.40

Press **OK** to enter the first input parameter set status. Select parameter M with **+**, **-** and set the parameter value with **▲**, **▼**. When M01 appears, press **OK** and the first parameter will be set to M1. The following will be on the LCD panel:

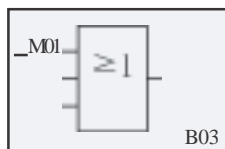

Fig. 4.41

## Chapter IV Programming operation



Press **▼** to move the cursor to the second input parameter **OK** and press **OK**. Now the second input parameter can be set. After selecting X with **▲**, **▼** and pressing **OK**, the said input is set to X. The following will be displayed on the LCD panel:

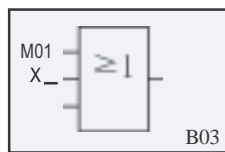

Fig. 4.42

Move the cursor to the third input link and press **OK**. After selecting M in the parameter list, press **OK** and set the said input to M2 with **+**, **-**. The following will be on the LCD panel:

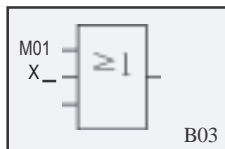

Fig. 4.43

Move the cursor to the output link with **▶** and press **OK**. After selecting Q in the parameter list, press **OK** and set the said output link as Q1 with **+**, **-**. The following will be displayed on the LCD panel:

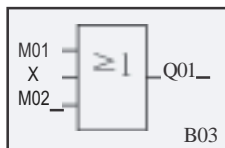

Fig. 4.44

## FAB Intelligent Control

---



Now all the three function blocks required for editing of this function diagram are selected and set, which means that the Function Diagram is completely edited.

Step III: Run

1. After Set up II is finished, press **ESC** twice consecutively to return to the Select Function Selection. The following will be displayed on the LCD panel:

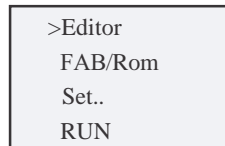

**Fig. 4.45**

2. Move> to RUN and press **OK** The following will be on the LCD panel:



**Fig. 4.46**

3. It means that the program is now written into FAB and can be run according to the new program.



**Notes:**

*How to read and modify the current program.*

*Press ESC and OK simultaneously to enter the password frame, and then enter the correct password, and then press OK.*

*Select FAB/ROM and press OK*

*Select ROM -FAB, and then press OK*

*Press **▶** and **◀** to select and read the function block, and press OK to confirm and to make the modification.*

**Chapter IV Programming operation**

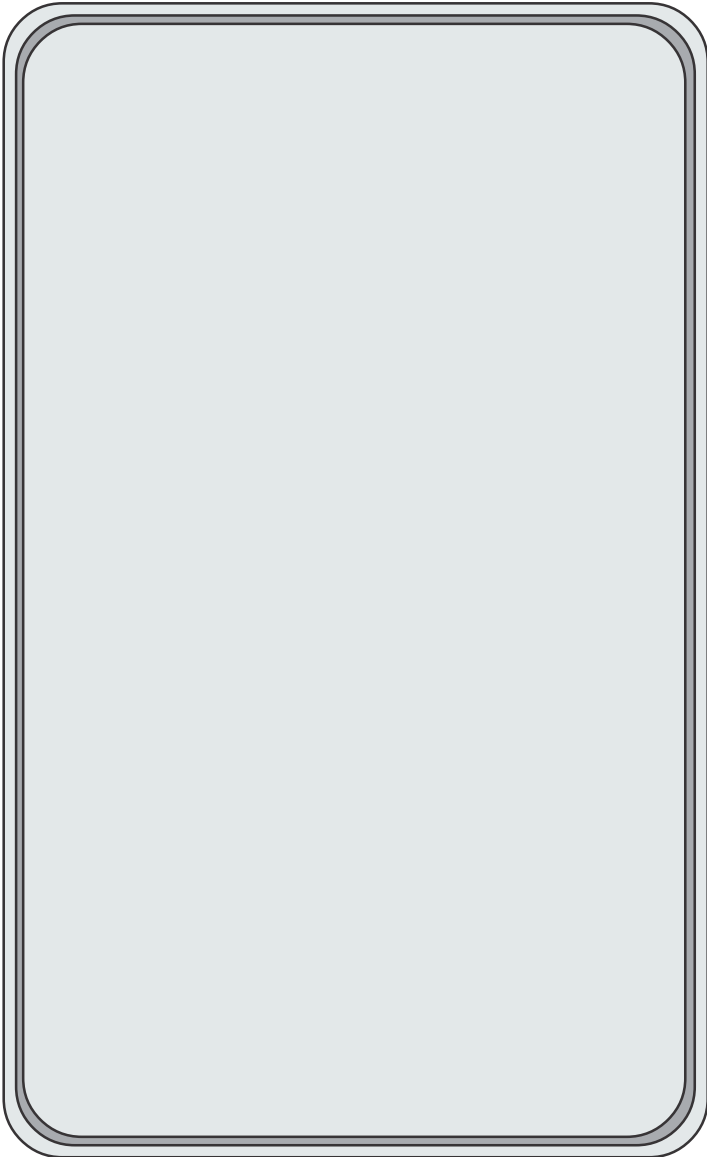



**Chapter V Remote programming and monitoring**

**5.1 Remote programming and monitoring via a MODEM**

FAB can realise ultra-remote programming and monitoring function through a MODEM. If you need to program or monitor a FAB on a work site kilometers away or even between two cities, this function of FAB will satisfy your requirement.

After the connection of FAB, AF-C232 (or AF-MUL), AF-M232 and MODEM (refer to 5.2 for details of the connection diagram), switch on the power and the MODEM will automatically complete the initialization. If the MODEM is not initialized, you may press **OK** on the MODEM menu under FAB/ROM of the LCD programming interface to initialise it.

Connect the MODEM to a computer provided with QUICK II or FAB-SCADA software and make a connection with FAB by dialing the telephone connected to FAB through the computer. Remote programming and monitoring can now be carried out.

Note: AF-M232 is a standard ARR AY product.

AF-M232 is a standard DB9 ↔ DB9 connection.

The Cable Connection Diagram for AF-M232 is as follows:

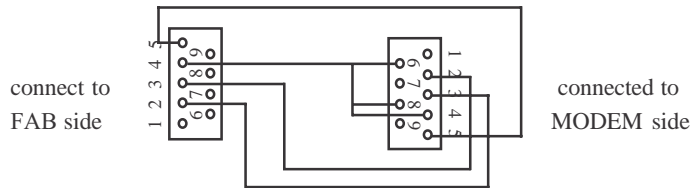



5.2 Two connection methods for FAB remote programming and monitoring

5.2.1 Connect MODEM by means of AF-C232 and AF-M232

For connecting with this method, you will need the following parts: FAB-C232 and AF-M232. The connection diagram is as follows:

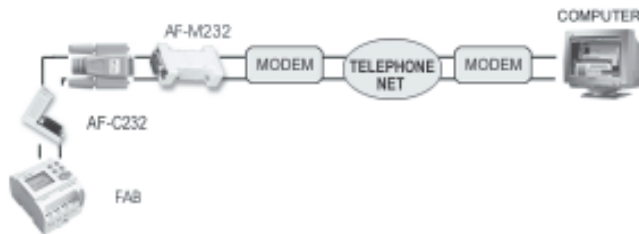

5.2.2 Connect MODEM by means of AF-MUL

If you have the AF-MUL telephone and voice multifunction block, it is not necessary to have the AF-C232 part. The connection diagram is as follows:

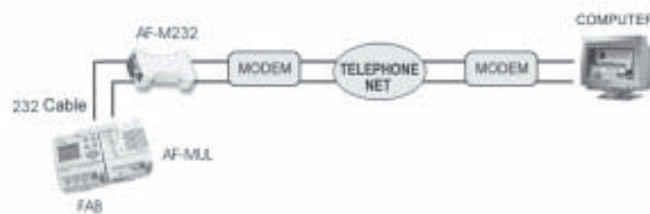

**FAB Intelligent Control**

---

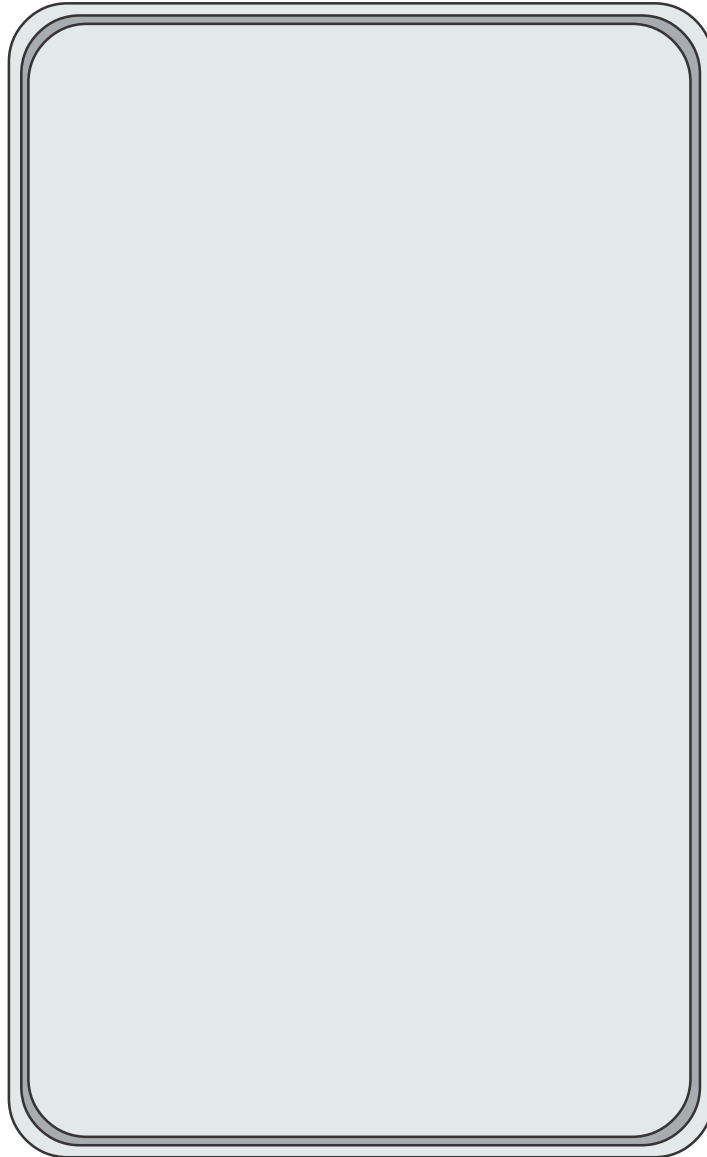



Chapter VI Voice Module

Voice alarm function, telephone control function and dialing automatically function are very important functions of FAB. To realize these functions, we should match FAB with the AF-MUL telephone and voice multifunction block.

6.1 The structure of the voice module:

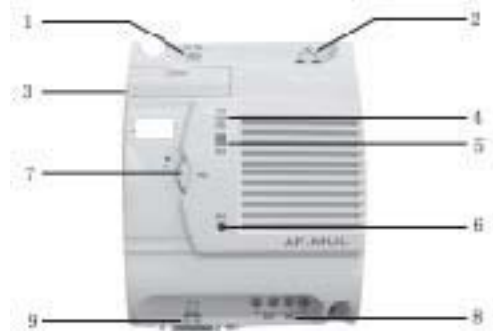

Fig 6.1 Structure of AF-MUL

- 1. Socket of telephone crystal plug
- 2. Power terminals (AC100-240V) or (DC12-24V)
- 3. Connecting Port with FAB
- 4. Power indicator
- 5. Recording indicator
- 6. Recording Microphone
- 7. Volume control 1 (controls the volume of AF-MUL Speaker)
- 8. Terminal port for external speaker (it can be connected to an externally powered-speaker to amplify the voice, the volume is not controlled by 7 (Volume control)
- 9. Communication Port: Connected with the computer to monitor or program the FAB or Connected with a MODEM via M232 part to remote monitor FAB (the same function with AF-C232 part).



### 6.2 Connection between AF-MUL and FAB.

Connect the power to the AF-MUL and FAB and then plug the telephone connector into the TEL socket . Connect the AF-MUL and FAB by using the special connection. (Please use the link connection provided forming part of the AF-MUL supply). As figure 6.2 shows.

For convenient installation there is a DIN rail clamp on the bottom of the AF-MUL. Both AF-MUL and DAB can be readily installed on a common DIN rail.

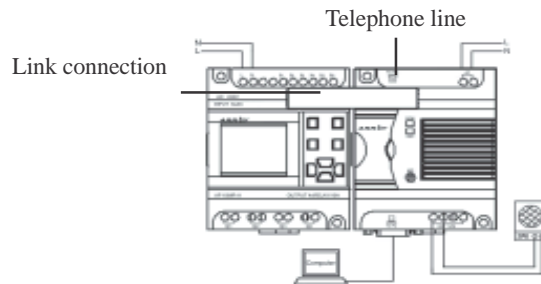

Fig 6.2 Connection Between FAB and AF-MUL

*Note:* (Before recording or amending the voice messages, you should use a 232 cable for the communication between computer and AF-MUL telephone and voice multifunction block (FAB and AF-MUL) as shown in above diagram.

### 6.3 Guide for using the voice multifunction block

1. The first four sections (section 0, section 1, section 2, section 3, are for the voice system, users can not record the four sections randomly.

Section 0, is the prompt voice for confirming the user status , It will be broadcast only when the AF-MUL system number has been dialed.

Section 1, is the prompt voice for confirming the input of this section and it can not be broadcast without using the correct password .It will be broadcast when the correct password is input. Normal broadcasting can be carried out with this section.

Section 2, is the prompt voice for the wrong password .It will be broadcast when the wrong password is used. Normal broadcasting can be carried out with this section.



Section 3: is the prompt voice for dialing to a connected telephone. It will be broadcast when the FAB dials a connected telephone. Normal broadcasting can be carried out with this section.

2. The usage of the four special sections.

For example: users can use four message sections as follows.

(1) Record section O as **Please enter the password for confirmation**

Record the 1st section as **correct password**. You can then carry out the next step.

Record the 2nd section as **wrong password**. You can then re enter the password.

Record the 3rd section as **Alarm** You can then enter the password and carry out the real time control.”

(2) When a user dials the FAB system number, AF-MUL will answer the telephone automatically and broadcast -please enter the password for confirmation, then the user enters the password.

A. If the entered password is correct, FAB system will then broadcast-correct password-please do the next step to control. Then the user can control the equipment by use of the telephone.

B. If the entered password is not correct the FAB system will broadcast-wrong password , please re-enter. The FAB system will then broadcast the section 0 message repeatedly.

(3) When the FAB voice system dials a preset telephone number, it will broadcast the preset message such as the 4th section Gas leakage alarm together with the 3rd section Alarm, please enter the password to control.

A. When user enters the correct password, the voice system will broadcasts the 1st message and then will broadcast the 4th message repeatedly. At this time the user can real-time control the equipment by use of the telephone.

B. When the user enters a wrong password, the voice system will broadcast the 2nd message-wrong password, please re-enter, The voice system will then broadcast the 3rd message and 4th message repeatedly.



**Notes:**

- A.** When a connected telephone is dialed by the FAB voice system, if there is no answer or a password is not input within 40 seconds of the connection the FAB voice system will stop dialing and cease to broadcast the voice message. The FAB voice system will then redial automatically every 20 seconds.
- B.** User must enter a \* before entering the password. The broadcasting will then stop and the user should enter a four-digit password within nine seconds. If the user fails to enter the password, the FAB voice system will rebroadcast the prompt voice. The user must then enter \* first and then enter the password, if the user needs to enter the password again the procedure needs to be repeated..
- C.** When the user has entered the correct password, the voice system will broadcast the 1st section-correct password-please do the next operation. The user can then carry out the following operation. If the password is wrong, the voice system will broadcast the 2nd message-wrong password -please re-enter. The user can only enter the wrong password twice. If the user enters the wrong password for the third time, FAB will hang up the telephone and stop broadcasting. The FAB will then return to the main system. If the alarm status still exists, the voice system will dial automatically, for alarm purposes, every 20 seconds.
- D.** When the alarm status exists, FAB will broadcast the alarm voice repeatedly every 20 seconds, it can be stopped by the use of the control function within the program.
- E.** When the broadcast has stopped the user should enter the four-digit password within nine seconds. If the user fails to enter the correct password, the FABvoice system will rebroadcasting the prompt voice. The user must then enter \* first and then the four digit password within nine seconds after the broadcast has ceased.
- F.** After FAB has dialled out if the user does not switch-off the alarm ON/OFF switch via the anti-control function i.e, the cause for alarm is not corrected the FAB will dial, for alarm purposes, automatically every 20 seconds.



### 6.4 Recording

The recording function of FAB-MUL is similar to a voice message telephone or recording machine. Then, how to record? The FAB provides a record function MR block. The method for using the MR block is as follows

When ON is 1 and OFF is 0, begin the voice recording.

When ON is 0 and OFF is 1, stop the voice recording.

The recording range of output Q is from 0 to 98 messages and the inputting of voice messages must be sequential.

**Notes:**

*The user shall record messages in a progressive sequence from 0 to 99. The sequence cannot be changed. For example, it is not possible to record the third message after the first message. The user should record the third message after the second message and so on.*

*Message 0 (base section) is for prompt words. When the user dials the voice module, the user will hear the base section prompt voice message. This voice message through the telephone is not controlled by the play function.*

*When output Q is 99, it does not mean that the user can record the 99th message. Q 99 is used to wipe away all of the recorded messages. Output Q 99 is similar to the delete button of recording machine. The user must delete all originally recorded messages within the AF-MUL before commencing a new set of voice recordings.*

**Example:** The user wants to record voice messages as follows:

The 0 base section message-Please enter the password.

The First section message-correct password, please enter the message code.

The Second section message-wrong password, please re-enter again.

The third section message-emergency, please enter password to control

The Fourth section message- Whatever message four is.

And so on to the system needs.

The voice message recording operation of is as follows:

1. As shown in Fig 6.4, connect the AF-MUL and FAB, connect switch k1 between L and I1, connect k2 between L and I2, connect k3 between L and I3 and connect k4 between L and I4.

## FAB Intelligent Control

---



Fig 6.3

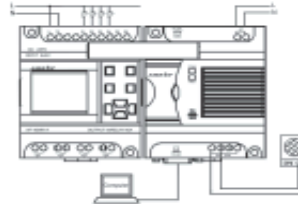
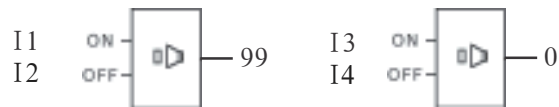

Fig 6.4

2. Switch on the power of FAB and AF-MUL, Write the two function blocks program in FAB when they run.



3. Run the FAB and close the switch k1 one second and open it, then close switch k2, one second and open it, then the original recording of FAB is deleted.
4. Close k3 for one second and open it, the user will see that the red recording indicator light of the AF-MUL is on, user to say-Please enter the password into MIC of the AF-MUL, then close k4 for a second and then open it. Now the user will hear the recorded voice-Please enter the password. The voice message is broadcast by the AF-MUL and proves that 0, the base section voice message has been recorded in the AF-MUL.
5. Close k3 for one second and then reopen it, the user should then close k3 again for one second again. When the red recording indicator light is on, user to say the second section voice message into MIC of the AF-MUL. This will complete the second section voice recording.
6. Repeat 5 above for additional voice messages until all sequential voice recordings have been completed.



**6.5 Sound broadcasting**

Write the sound playing FB into the FAB and set up the property. Set up the relevant broadcasting voice section, section 04 and section 08, as follows:



When the program has been written into FAB, and the FAB run, turn on the switch K1 for one second then turn it off. At this time you will hear-the fourth section voice, then turn on the switch K2 for one second then turn it off and the broadcast will be closed.

Turn on the switch K3 for one second and turn it off, you will hear -the eighth section-you recorded voice. Turn on the switch K4 and then turn off, the sound will be closed.

**Notes:** If the two broadcasting function blocks are both actioned, the function block with bigger number will be broadcast, which follows the principle - the later-command takes precedence over the earlier command.

**6.6 Telephone remote control function**

If the user wants to control distant equipment by mobile telephone or touch dial telephone, the user should connect FAB to AF-MUL, as shown in figure 6.2. Because FAB has an RS block which can be driven by the double-tone information. Signal (P0-P9), the user only needs to write the program with an RS block in FAB and it will work.

For example, if you want to let the P3 button control the Q2 of FAB, the user should write the following program into FAB beforehand. The AF-MUL broadcasts firstly a prompt voice (that is the recorded ground message) when the user dials the telephone number connected to an AF-MUL

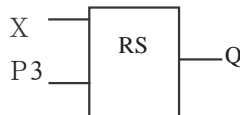

## FAB Intelligent Control

---



### Notes:

1. When the user enters the password, the system will prompt-Please enter information code. Press 3 on the telephone, then the output Q2 is connected
2. When you enter your password or other control signal code, you should enter \* before the number code.
3. If you want to disconnect the telephone, press # twice.
4. The system will shut down if there is action for 30 seconds or if a wrong password is entered.

### 6.7 Automatic dialing function

If you want to use the FAB to automatically dial alarm number, 112 or some telephone number, in emergency, use the procedure as follows.

First, connect FAB with AF-MUL. As figure 6.2.

Second, use the TEL block when you are programming. Write the number that you want to dial in advanced, for example 34568. The system will dial the number automatically when I1 receives the signal:

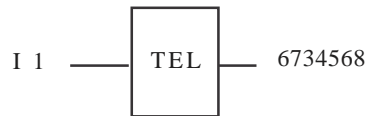

### 6.8 Example for using the voice module for control and security

Control requirement:

First, control the home electrical equipments by the telephone's buttons.

P0: The air-conditioner is turning on

P1: The air-conditioner is turning off

Second, a sensor is fitted to doors and windows. If there is an illegal entry the voice module will be activated with the prerecorded message- Seize the thief. It will also automatically dial your designated telephone for alarm purposes.

In order to establish the control in the above examples the user should set the voice module as follows:

0: Please enter a password.



- 1: Correct password, please enter control information code.
- 2: Wrong password. Please enter again.
3. Emergency, please enter the password and control message.
- 4: Turn on the air-conditioning.
- 5: Turn off the air-conditioning.

The first step: refer to section 6.3, record the above six voice messages.

The second step: connect I0 with the doors and windows sensors.

The third step: edit program as follow.

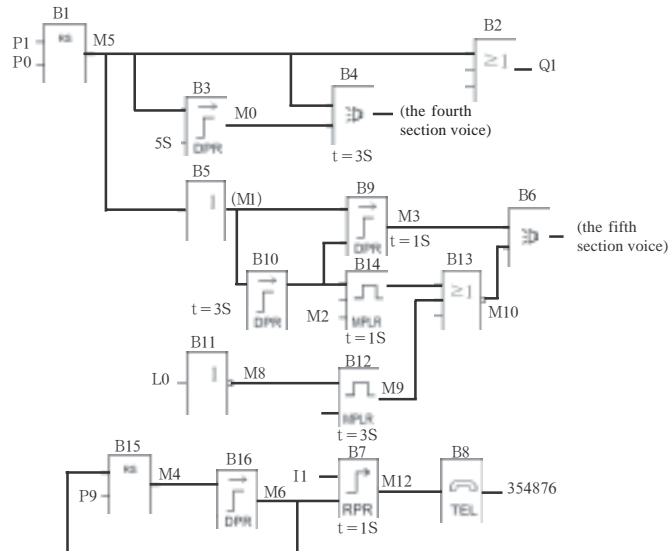

The user will now have completed the connection and installation of FAB, AF-MUL and ancillary parts. The voice recording and programming will also have been completed.

When the user dials the number which the AF-MUL is programmed to connect to the user will hear-Please enter password. The user should enter \* and then the correct password.

## FAB Intelligent Control

---



Then the user will hear the prerecorded message-Please enter the control information password, and should then enter \* 0. The user will then hear- Turn on the air conditioner. The air-conditioning will be simultaneously turned on. Similarly the user could enter \* 1. The user will then hear-Turn off the air conditioner. The air conditioning will then be simultaneously turned off. Subject to the extent of the programming if the user enters \* 3 the user will hear-Turn on the hot water heater. The hot water heater is simultaneously turned on. When the user enters \* 4 the user will hear-Turn off the hot water heater. The hot water heater is simultaneously turned off. If switch I1 is activated, the prerecorded voice message-Seize the thief-will be broadcast and the preset telephone number dialled for remote alarm.

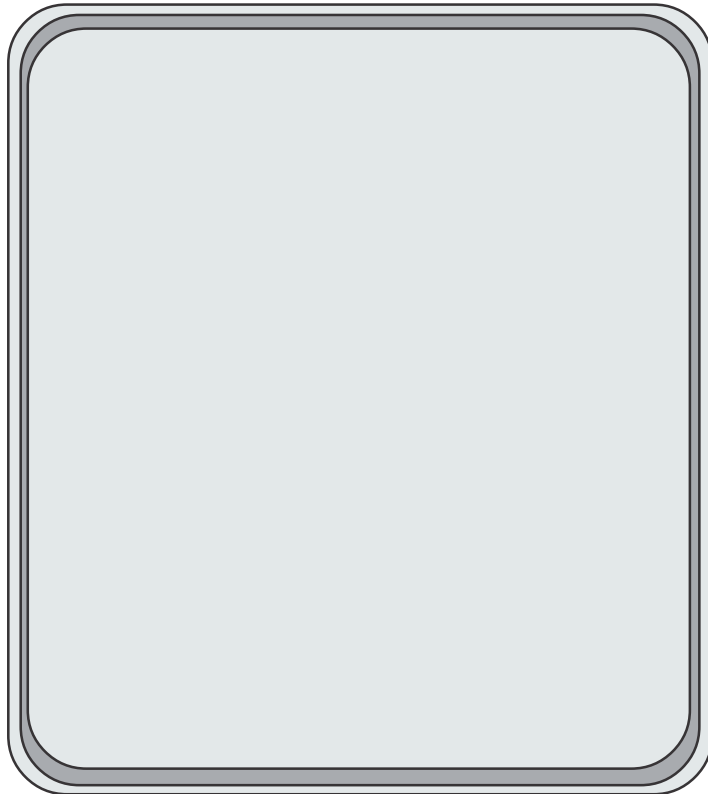



Chapter VII Technical specifications

7.1 General technical specifications

| Item                                | basis                              | condition  |
|-------------------------------------|------------------------------------|--|
| Climate environment                 |                                    |  |
| ambient temperature                 | cold: IEC68-2-1,<br>hot: IEC68-2-2 |  |
| Horizontal installation             |                                    | 0 ~ 55°C   |
| vertical installation               |                                    | 0 ~ 55°C   |
| Storage/transportation              |                                    | -40°C ~ +70°C  |
| Relative humidity                   | IEC68-2-30                         | 5% ~ 95%,<br>without condensation  |
| Atmospheric pressure                |                                    | 795 ~ 1080kpa  |
| Pollutants                          | IEC68-2-42<br>IEC68-2-43           | H2S1cm3/m3, 4days<br>SO210cm3/m3, 4days  |
| Mechanical environment              |                                    |  |
| Protection type                     |                                    | IP20   |
| Vibration 2                         | IEC68-2                            | 10 ~ 57Hz (constant amplitude 0.15mm)<br>57 ~ 150Hz (constant acceleration 2g) |
| Impact                              | IEC68-2-27                         | 18 impacts (semi sine 15g/11ms)  |
| Fall                                | IEC68-2-31                         | falling height 50mm  |
| Freely falling body (with package)  | IEC68-2-32                         | 1m   |
| Electromagnetic compatibility (EMC) |                                    |  |
| Static discharge                    | severe grade 3                     | 8kv air discharge,<br>6kv contact discharge                                    |
| Electromagnetic field               | IEC801-3                           | field strength 10V/m   |
| Interference suppression            | EN55011                            | limitation grade B group 1   |
| Shock pulse                         | IEC801-4<br>severe grade 3         | 2.2kV for power line<br>2.2kV for signal line                                  |
| IEC/VDE safety information          |                                    |  |
| Insulation Intensity                | IEC1131                            | meeting the requirement  |



7.2 AF-10AMR / AF-20AMR

|  |   |
|--|---|
| Power Supply                                     |   |
| Allowable range of<br>8 input voltage rating     | 110/240VAC                              |
| VDE0631:   | 85V ~ 250V AC                           |
| EC1131:  | 85V ~ 256V AC                           |
| Allowable main frequency                         | 47 ~ 63Hz                               |
| 250° Clock buffer memory                         | 100 hours                               |
| Real time clock accuracy                         | Typical ±1s /day                        |
| Power consumption                                | AF-10AMR(3W)<br>AF-20AMR(5W)            |
| Data Capacity Input                              |   |
| Input Voltage L1                                 |   |
| Signal 0   | 0V ~ 40VAC                              |
| Signal 1   | 80V ~ 250VAC                            |
| Input Current                                    | Typical 0.24mA                          |
| Signal 1   | at 230VAC                               |
| Delay Time                                       |   |
| Changed From 1 to 0                              | Typical 50ms                            |
| Changed From 0 to 1                              | Typical 50ms                            |
| Length of Power Line<br>(without shield)         | 100m                                    |
| Data Capacity Output                             | Yes                                     |
| Output Type                                      | Relay Output                            |
| Electrical Isolation                             | Yes                                     |
| Group  | 1                                       |
| Continuous Current Ith                           | Max. 10A                                |
| Incandescent Lamp Load<br>(25,000 switch cycles) | 1000W (230/240VAC)<br>500W (115/120VAC) |



|   |                                     |
|---|-------------------------------------|
| Fluorescent Light Tube With Electrical Controller<br>(25,000 Switch Cycles) | 10 x 58W (230/240VAC)               |
| Fluorescent Light Tube With Regular Compensation<br>(25,000 Switch Cycles)  | 1 x 58W (230/240VAC)                |
| Fluorescent Light Tube Without Compensation<br>(25,000 Switch Cycles)       | 10 x 58W (230/240 VAC)              |
| Short Circuit Protection cos 1  | Power Supply Protection<br>B16 600A |
| Short Circuit Protection cos 0.5 ~ 0.7                                      | Power Supply Protection<br>B16 900A |
| Output Relay Protection   | Max. 20A<br>Feature B16             |
| Switch Frequency  |                                     |
| Machine   | 10Hz                                |
| Resistor Load / Lamp Load   | 2Hz                                 |
| Induced Load  | 0.5Hz                               |

7.3 AF-10DMT / AF-20DMT

|  |                 |
|--|-----------------|
| Power supply                               |                 |
| Input Voltage                              | 24VDC           |
| Rating                                     | 20.4V ~ 28.8VDC |
| Allowable Range                            |                 |
| 24VDC Power Consumption (Output Full Load) | Typical 1.23A   |
| Digital value input                        | Typical 0.6W    |
| Data Capacity Input                        |                 |
| Input Voltage (24VDC)                      | 24VDC           |
| Rating                                     | 24VDC           |
| Signal 0                                   | <5.0V DC        |
| Signal 1                                   | >15.0VDC        |



|  |   |
|--|---|
| Input Current for Signal 1                               | Typical 3mA   |
| Delay Time<br>Changed from 1 to 0<br>Changed from 0 to 1 | Typical 50ms<br>Typical 50ms                            |
| Length of Power Line (Without Shield)                    | 100m  |
| Data Capacity Output                                     |   |
| Output Type  | Crystal Tube Current Source                             |
| Output Voltage   | <=80VDC   |
| Output Current   | Max. 0.3A   |
| Short Circuit Protection and<br>Overload Protection      | Yes   |
| Short Circuit Current Limit                              | Approximately 1A  |
| Rating Reduction   | Rating is Not Reduced in the<br>Whole Temperature Range |

7.4 AF-10DMR / AF-20DMR

|  |   |
|--|---|
| Power Supply   |   |
| Input Voltage<br>Rating<br>Allowable Range                 | 24V DC<br>20.4 ~ 28.8VDC                |
| Power Consumption of<br>AF-10DMR / AF-20DMR at 24VDC       | Typical 1.5W                            |
| Data Capacity Input  |   |
| Input Voltage<br>Rating<br>Signal 0<br>Signal 1            | 24VDC<br>24VDC<br><5.0V DC<br>>15.0V DC |
| Input Current for Signal 1                                 | Typical 3mA                             |
| Delay Time<br>Changing from 1 to 0<br>Changing from 0 to 1 | Typical 50ms<br>Typical 50ms            |



|   |                                      |
|---|--------------------------------------|
| Length of power line (Without Shield)                                       | 100m                                 |
| Data Capacity Output  | Digital Value Output                 |
| Output Type   | Relay Output                         |
| Electrical Isolation  | Yes                                  |
| Group   | 1                                    |
| Continuous Current Ith  | Max. 10A                             |
| Incandescent Lamp Load<br>(25,000 switch cycles)                            | 1000W                                |
| Fluorescent Light Tube with Electrical Controller<br>(25,000 switch cycles) | 10 x 58W                             |
| Fluorescent Light Tube with Regular<br>Compensation(25,000 switch cycles)   | 1 x 58W                              |
| Fluorescent Light Tube without<br>Compensation(25,000 switch cycles)        | 10 x 58W                             |
| Short Circuit Protection cos 1  | Power Supply Protection<br>B16, 600A |
| Short Circuit Protection cos 0.5 ~ 0.7                                      | Power Supply Protection<br>B16, 900A |
| Parallel connected Output for increased Power                               | Not Allowed                          |
| Output Relay Protection   | Max. 20A Feature B16                 |
| Switch Frequency  |                                      |
| Mechanical  | 10Hz                                 |
| Resistor Load/Lamp Load   | 2Hz                                  |
| Induced Load  | 0.5Hz                                |

**7.5 Telephone number receiving, transmitting and voice blocks**

| Index                 | Conformity   |
|-----------------------|--|
| Automatic Receive     | CCITT-DTMF   |
| Automatic transmit    | CCITT-DTMF   |
| Voice Record and Play | Max. 98 segments,<br>Each with Arbitrary Time (4min, 8min) |

**FAB Intelligent Control** \_\_\_\_\_





### Chapter VIII Application

FAB has a very wide application range. In order to let the user consider the wide application potential for FAB and the convenience brought about by its use, we will show some common and representative control schemes herein. After the user has read these application examples it will be clear how simple it is to use FAB to establish automatic control requirements, especially in a system requiring time control and in the automatic control of intelligent living quarters etc.

#### **8.1 Bell control for schools, factories and the like**

Control requirements:

Monday to Friday: 6:00:00 to 12:00:00 AM, the bell shall ring once every hour for 10 seconds; 14:00:00 to 17:00:00 PM, the bell shall ring once every hour for 10 seconds.

Saturday and Sunday: 8:00:00 to 12:00:00 AM, the bell shall ring once every 2 hours for 10 seconds; 13:00:00 to 17:00:00 PM, the bell shall ring once every 2 hours for 10 seconds.

Action required:

to realize the above control, the control of 11 time intervals from Mon to Fri and 6 time intervals on Sat and Sun is necessary. In the relay control used in the past, a lot of time-delayed relays are needed and the line connection is quite complicated. Using FAB, all these will become very simple. Please refer to the function diagram for realisation of the control, as shown in the following figure. There is only one line section for its required external connection, which means that you can realise the timing control of the school bell only by connecting one output of FAB directly to the bell. The program diagram is as follows:

## FAB Intelligent Control

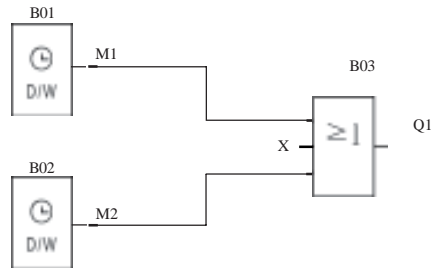

When FAB is used for the above control, it is very simple both in the connection of the external line and in editing the program. When QUICK II programming software is used for editing the control program, it is only necessary to set two time switch blocks.



The set of FB is as follows:



| Records | Status | Time    |
|---------|--------|---------|
| 0       | ON     | 0-0-0   |
| 1       | OFF    | 0-0-10  |
| 2       | ON     | 1-0-0   |
| 3       | OFF    | 1-0-10  |
| 4       | ON     | 0-0-0   |
| 5       | OFF    | 0-0-10  |
| 6       | ON     | 0-0-0   |
| 7       | OFF    | 0-0-10  |
| 8       | ON     | 10-0-0  |
| 9       | OFF    | 10-0-10 |
| 10      | ON     | 11-0-0  |
| 11      | OFF    | 11-0-10 |
| 12      | ON     | 12-0-0  |
| 13      | OFF    | 12-0-10 |
| 14      | ON     | 13-0-0  |
| 15      | OFF    | 13-0-10 |
| 16      | ON     | 14-0-0  |
| 17      | OFF    | 14-0-10 |
| 18      | ON     | 15-0-0  |
| 19      | OFF    | 15-0-10 |
| 20      | ON     | 16-0-0  |
| 21      | OFF    | 16-0-10 |

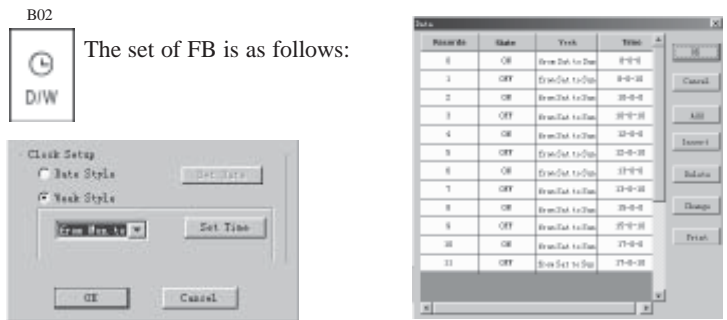

The set of FB is as follows:

**8.2 The illumination of multifunction switch in stairs, halls etc.**

1. When the light switch has been pressed, the illumination will be connected and then be cut off automatically after the set time of 3 minutes.
2. Lights glimmer for 5 seconds before being switched off.
3. When the switch is pressed again, the illumination will be on as usual.
1. When the switch is pressed for more than 2 seconds the illumination will be on as usual.
5. The illumination will be automatically connected every day at PM6:30 and be cut off every day at AM6:30, the function block program diagram as follows:

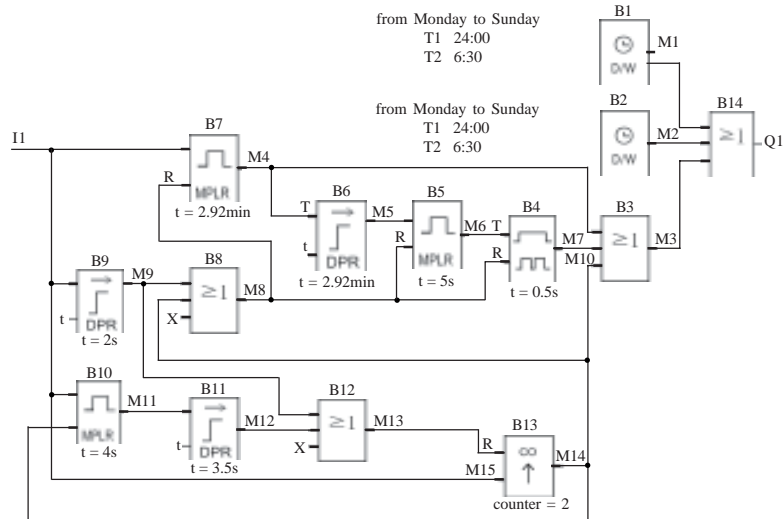



**8.3 Automatic gate control requirements:**

1. Opening and closing of the gate shall be controlled by the guard in the control room.
2. Normally the gate shall be opened or closed completely, but the opening and closing action can be interrupted at any time.
3. The alarm lamp shall begin to flash when the gate acts and shall keep flashing as long as the gate continues to move.
4. A pressure damper shall be provided so that the gate can be automatically opened when it touches a person or an article.

The Function Block Program Diagram is as follows:

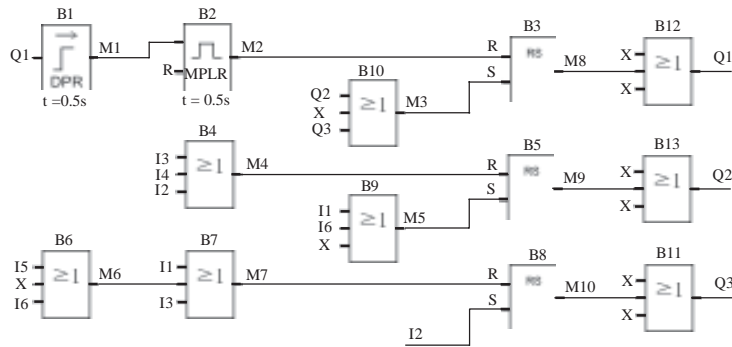

**Note:**

- Q1 shall be connected to the flashing lamp;*
- Q2 the gate-open motor contactor;*
- Q3 to the gate-close motor contactor;*
- I1 to gate-open switch; I2 to the gate-open switch; I3 to the stop switch; I4 to the gate-open limit switch; I5 to the gate-close limit switch; and I6 to the safety pressure damper.*



### 8.4 Ventilation system

Requirements: The ventilation system shall be able to send fresh air into the room and to exhaust the waste gas out of the room;

1. Waste gas exhaust unit and fresh air forced-draft unit shall be installed in the room.
2. The ventilation system shall be controlled by the control monitor.
3. No over atmospheric pressure is allowed in the room at any time.
4. The fresh air forced-draft unit can not be put into service until the flow monitor indicates that the waste gas exhaust unit is in normal operation.
5. In case of any fault in the ventilation system, the alarm lamp shall be on.

The Function Block Program Diagram is as follows:

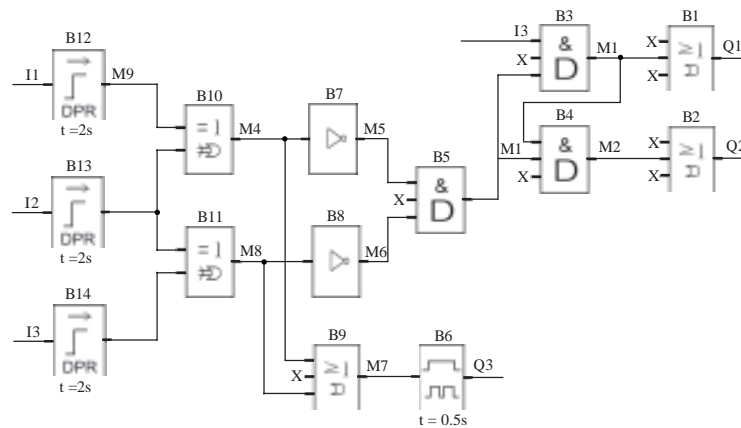

**Note:**

- Q1 shall be connected to the contactor of waste gas exhaust unit;*
- Q2 to the contactor of the fresh air forced-draft unit;*
- Q3 to the fault alarm lamp;*
- I1 to the activate exhaust switch;*
- I2 to the stop exhaust switch;*
- I3 to the waste gas flow monitor;*
- I4 to the fresh air flow monitor.*



**8 . 5 Control requirements for neon lamp control system:**

1. Display mode, for example: ARRAY Electronics Welcomes You !

- 1 . 1 Displaying ARRAY
- 1 . 2 Displaying ARRAY Electric
- 1 . 3 Displaying Welcomes You!”
- 1 . 4 Displaying ARRAY Electric Welcomes You
- 1 . 5 Displaying Welcomes You!
- 1 . 6 Displaying ARRAY Electric
- 1 . 7 Cycling 1.1 ~ 1.6

2. Control requirements

1) The neon lamp shall be automatically turned on at 18:00 and off at 24:00 every day.

2) The control can be switched over with the manual/automatic/off selection switch.

Manual: The neon lamp control system can be activated through the manual switch -at any time.

Automatic: The neon lamp control system can be automatically activated when the clock switch or light sensitive switch triggers the output.

Off: The neon lamp system shall be switched off as the manual/automatic/off selection switch is pressed twice and switched on as it is pressed for the third time.

3) The light sensitive switch shall be provided to complement the time switch so that the lamp will be automatically turned on when the light is weak and off when the light is sufficient.

4) Rain detector: On a rainy day, the neon lamp system shall be automatically switched off.

5) Over (under) voltage detector: The system will be automatically switched off when the operating voltage of the neon lamp is too high or too low.

3. Input/output assignment

- I1 rain detector.
- I2 over (under) voltage detector.
- I3 light sensitive switch.
- I4 manual/ automatic/off selection switch.



Q1 to be connected to the enable terminal of ARRAY segment;  
 Q2 to the enable terminal of Electronics segment;  
 Q3 to the enable terminal of Welcome You! segment.  
 Following is the Function Block Program Diagram:

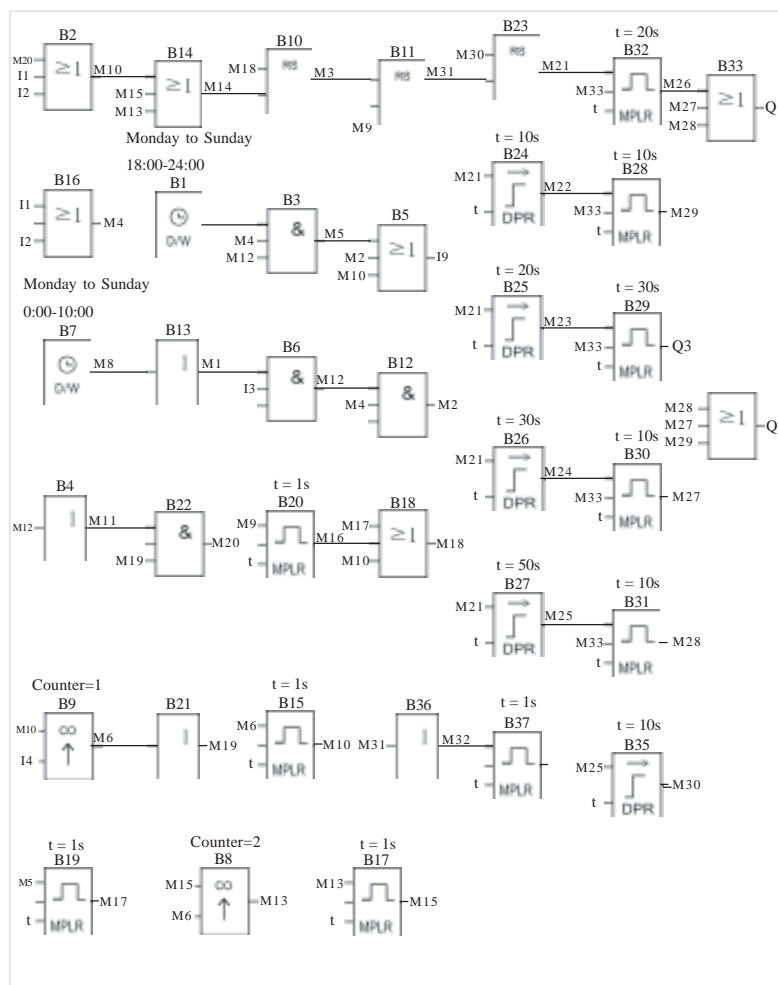



**8 . 6 Illumination system for display windows**

Control requirements:

1. Basic lighting for the display period:

a) Time:

- Monday to Friday 8:00~22:00;
- On Saturday 8:00~24:00;
- On Sunday 9:00~20:00;

b) Automatic off: the basic lighting can be automatically turned off whilst maintaining minimum illumination and display lighting.

2 . Additional requirements for night lighting :

a) Time:

- Monday to Friday light sensitive switch is triggered at 22:00 ;
- On Saturday light sensitive switch is triggered at 24:00;
- On Sunday light sensitive switch is triggered at 20:00 ;

b) Light sensitive switch triggering/ automatic off: can automatically turn off the minimum illumination and the display lamps when it is on and can also automatically turn on the minimum illumination and display lighting when it is off.

3. Minimum illumination and display lighting in non-display period:

a) The minimum illumination and the display lighting shall be maintained and shall be automatically turned on when the shopping period ends and the basic lighting and night lighting are turned off.

4. Test switch:

All lamp groups can be tested when the test switch is pressed.

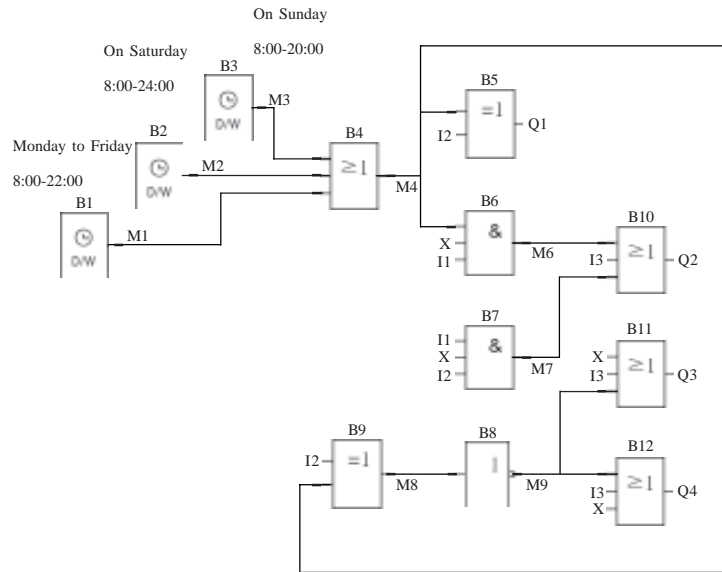

**Note:**

- I1 shall be connected to the light sensitive switch;*
- I2 to the auto/manual selection switch;*
- I3 to the test switch;*
- Q1 to the basic lighting in display period;*
- Q2 to the night additional lighting within display period;*
- Q3 to the minimum illumination maintaining during non-display period;*
- Q4 to the projection light for special commodities in non-display period.*

**8.7 Application of FAB in building management**

Control requirements:

1. Automatic reading of various meters: the watt-hour meter, water meter and gas meter can be read automatically;

## FAB Intelligent Control

---



- 2 . Fire protection and anti burglar functions can be realized;
- 3 . Start and stop of relevant electrical appliances can be controlled.

FAB can flexibly satisfy the automatic building control requirements and can realize central monitor and control in sephisticated intelligent living quarter.

### 1) FAB central control communication connection

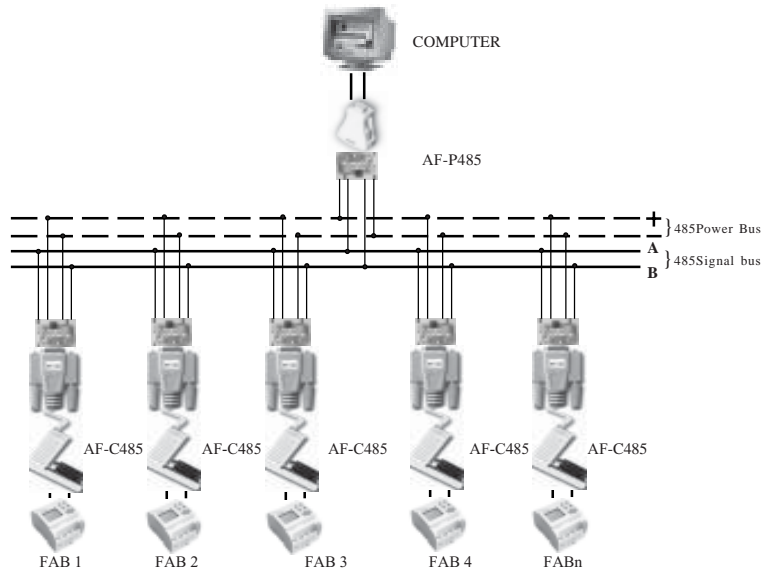

### 2) Assignment of FAB input/output points.

I1 shall be connected to the temperature sensor and Q0 shall be connected to the air conditioner so that the air conditioner is controlled by the temperature;

I2 shall be connected to the smoke and fire detector for alarm of fire;

I3 shall be connected to the gas detecting sensor,



Q1 shall be connected to the ventilation equipment and Q2 shall be connected to the alarm so that the ventilation equipment is controlled by the air status;  
 I4 shall be connected to the door/window sensor activating the alarm  
 I5 shall be connected to the water meter, while I6 shall be connected to the watt-hour meter.

**8.8 Application of FAB in a voltage diode counting and packing assembly line**

The PC Assembly Line Central Control System Diagram is as follows:

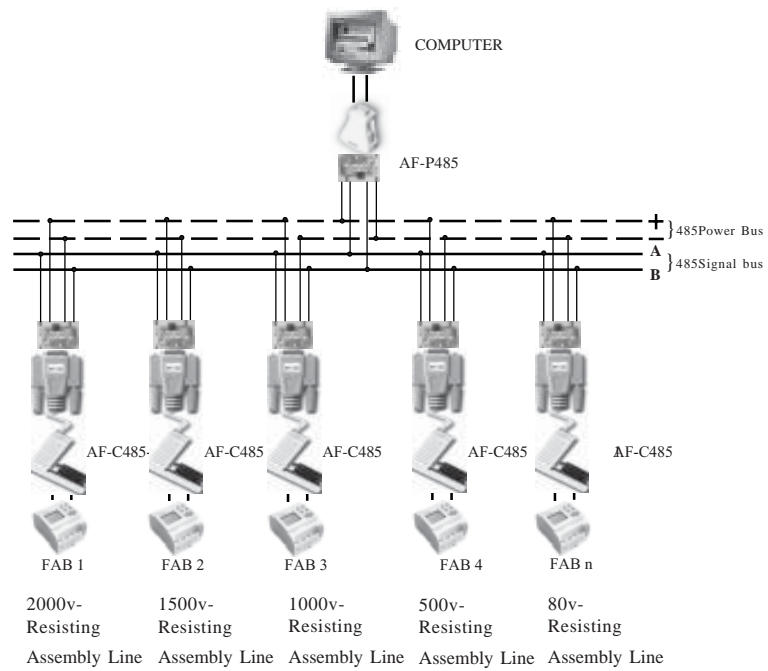

## FAB Intelligent Control

---



Control requirements and configuration:

1. Control of 2000V withstand voltage counting flow line, to be completed by FAB 1

1) I5 is used for counting the diodes entering the flow line (automatically giving the sum of the diodes to be tested);

2) I6 is used for counting of diodes with 2000V withstand voltage;

3) Q1 is used for labeling of diodes with acceptable withstand voltage;

4) Q2 is used for enclosing of diodes already labeled;

5) If the counting value of I6 is multiples of 1000, Q3 will be switched on to start the packing equipment;

6) Diodes that can not withstand 2000V voltage shall be transferred to 1500V flow line.

2. Control shall be completed by FAB 2 for 1500V withstand voltage flow line, by FAB 3 for 1000V withstand voltage flow line, by FAB 4 for 500V withstand voltage flow line and by FAB 5 for 80V withstand voltage flow line. The control requirements and configuration are the same as mentioned above.

3. Monitoring of all FAB is can be realized by installation of monitoring software FAB-SCADA on PC. Each FAB answers through bus 485 the instructions from PC, including diode counting and input/output (I/O) status of FAB; PC will display each acquired FAB data on the screen and can provide data storage and inquiry functions, to allow prompt analysis of the counting of different withstand voltage diodes.

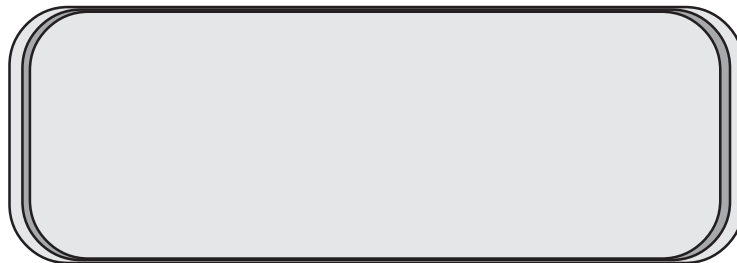



Chapter VIII Quality Guarantee

**Quality Guarantee** The product has been strictly tested for quality before delivery from our plant and it complies with (as appropriate) all product requirements listed in this manual. When properly installed it will work in accordance with its' specifications.

**Warranty Period** This product is warranted against defects in material and manufacturing for a period of one year from the date of delivery. During the warranty period, ARRAY shall be responsible for necessary repairs or replacement, as long as the product is proven to be inherently defective.

**Warranty Range** During the above mentioned Warranty Period, if the product is fails to perform in accordance with its' specifications and has not been misused it shall be delivered to a service centre, which ARRAY authorizes, for free repair. ARRAY reserves the right to repair or replace the product in accordance with it's discretion. In the event of product replacement the buyer will be informed and shall be responsible for reloading software, unless agreed otherwise. The buyer shall pay the shipping charge for delivery to the ARRAY service centre and the ARRAY service centre will repair or replace the product and deliver it to the buyer free of charge.

The above warranty does not include the following circumstances.

1. Improper installation testing or operation
2. Misuse
3. Damage caused by unauthorized dismantling of the product
4. Damage to consumable parts such as rubber cover, buttons, batteries, relays etc.

**FAB Intelligent Controller** \_\_\_\_\_

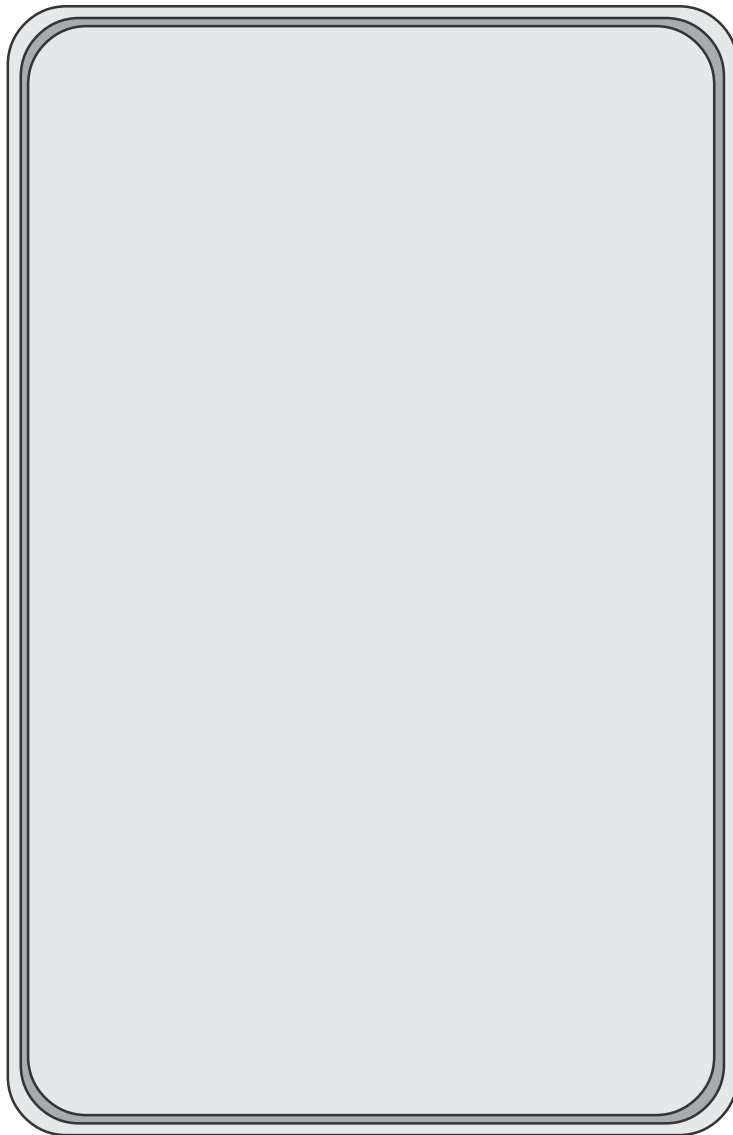



# QuickII SOFTWARE



### **QuickII: SOFTWARE**

Quick II is a programming software for a FAB controller (FAB), it is required to carry out programming and simulation on a computer. It can implement the preparation of a control program (function diagram) for FAB. It can also simulate the operation of the edited program and display the operation in a clear manner. The latter feature enables the accuracy of the edited program to be confirmed. QuickII can execute both short-distance and remote communication of FAB, and write an edited program into the EEPROM of the FAB.





**Chapter I Brief Introduction to Quick II**

In order to obtain a quick and initial understanding of Quick II we will, from this chapter forward, make a comprehensive introduction to Quick II with the help of visual pictures.

**1.1 Operating interface**

The operating interface of Quick II is friendly and all of its operations can be completed by clicking the mouse. By clicking **Start>Programs>Quick II** in the Windows taskbar, you can enter the main interface of Quick II, as shown in Fig. 1.2

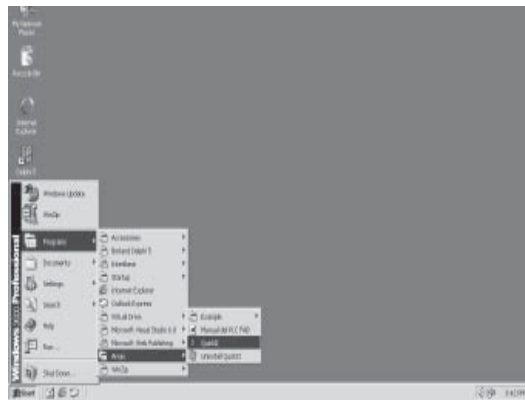
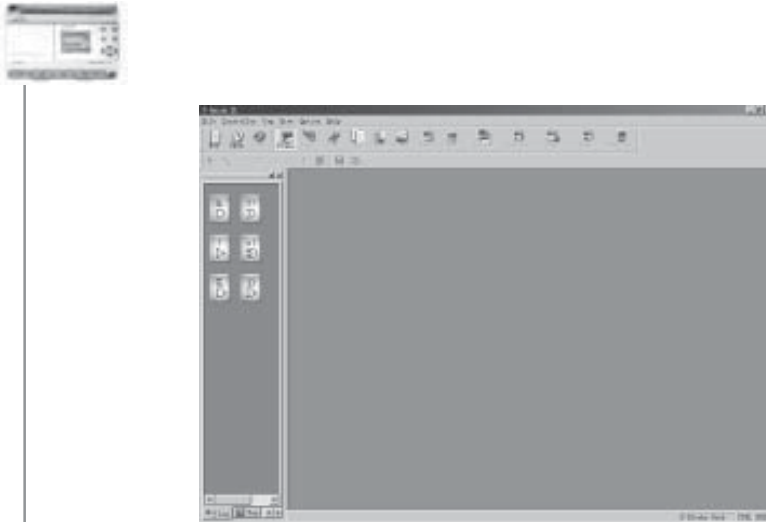

Fig. 1.1 Set up Quick II



**Fig. 1 . 2 Main Interface of Quick II**

For Quick II, the operating methods of pull-down Instruction Tools and Quick icons are adopted. All function blocks are directly distributed in the window. Using a mouse with Windows operation, you can perform; creating and editing, simulation running and monitoring of a FAB program quickly.

### **1 . 2 Two types of Editing windows**

Click **NEW**, then set the controller type and simulation type depending on requirements. Select a file name for storing in the computer. Two cascaded editing windows, the Logical Diagram Editing window and Field Simulation Graph Editing window, will appear in the window. You may select either one for editing purposes.

#### **1 . 2 . 1 FAB Logical Diagram Editing window**

FAB Logical Diagram Editing window is as shown in Fig. 1.3. In this editing window, you can click the desired block in the block library on the left to draw the Logical Function Diagram and set the block property. After the function diagram is completed, simulation can be run in this window and the program can be downloaded to FAB.

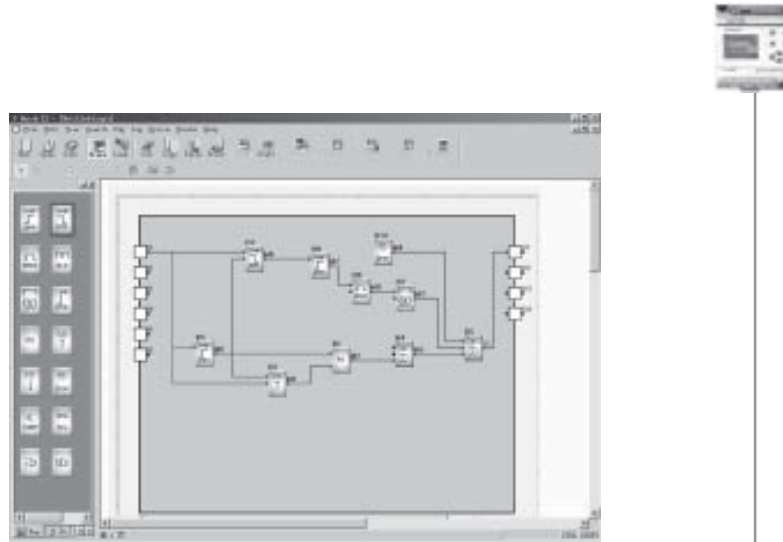

Fig. 1 . 3 FAB Logical Diagram Editing window

### 1 . 2 . 2 Simulation window

Quick II has two types of simulation window, the Standard Simulation window and the Simple Simulation window. The Standard Simulation (Graph editing) window is as shown in Fig.1.4. In this editing window, you can design the Field Simulation Graph with Draw, using the built in drawing tools, on the top of the editing window, based on the field device. The said Field Simulation Graph editing window is used to conform with the Function Diagram. When the Function Diagram and Field Simulation Graph are completed, you may activate simulation to execute real-time simulation of the field devices on the controlled site. The Simple simulation window is as shown in Fig.1.5, through which you can easily view the result of FAB operation.

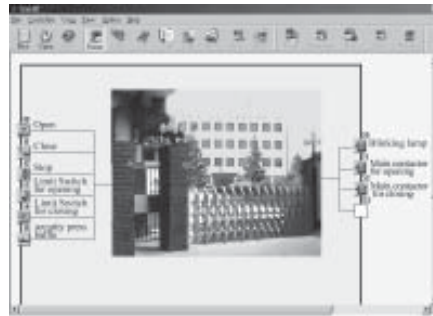

Fig. 1 . 4 Standard Simulation window

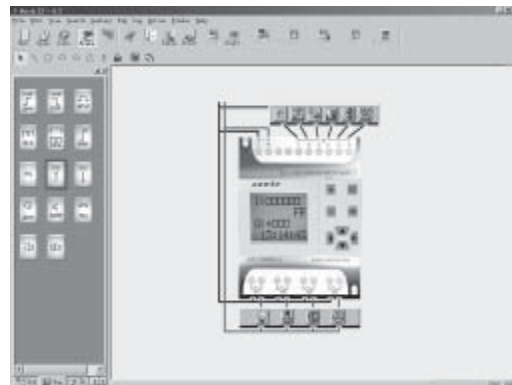

Fig. 1 . 5 Simple Simulation window

### 1.3 Main functions

#### 1.3.1 Editing function

The main function of Quick II is programming for FAB. By using the Logical Function Editing window of Quick II, you can create and edit your desired FAB programs using various function blocks of FAB and can also perform file operations such as save, print, etc.



**1 . 3 . 2 Simulation operation function**

After the program is edited, you can view the program operation result on the computer and conveniently check if the said program meets your control requirements. Here Quick II provides you with a completely new off-line test function, through which you can debug the program without installing the FAB on site. With this function, many inconvenience of the site test can be avoided.

**1 . 3 . 3 Real-time monitoring**

Quick II has a Real-Time Monitoring window. You can view the process of the control system and the running conditions of all FABs and control remote FABs, by connecting the FAB communication port to the computer you can view the process of the control system.

**1 . 3 . 4 Communication with FAB**

**1 . 3 . 4 . 1 Local FAB communication.**

Through use of an RS-232 communication port, communication between the FAB and a computer can be realized, allowing for easily downloading programs from the computer to FAB and uploading programs from FAB to the computer. Monitoring of operation conditions and controlling of FAB can also be carried out.

**1 . 3 . 4 . 2 Remote FAB communication**

In certain applications several sets of equipments may be located at disparate distances and far from each other. When frequent or urgent modification are needed, caused by unexpected events, during FAB operation, the problems can be easily solved by just connecting FAB to the telephone line through a modem.

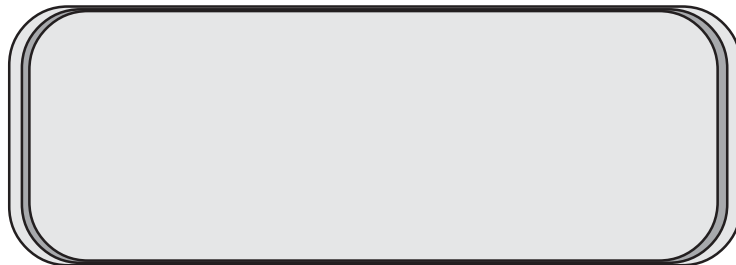



**Chapter II Installation and uninstallation**

**2.1 Installation of Quick II**

The installation of Quick II is very simple. A prompt dialogue box will appear automatically and you will complete the installation smoothly on the computer under its' guidance. The main steps are as follows:

1. Insert the CD-ROM with Quick II into the CD Drive and Installation Guidance will appear automatically. Select **Install>Quick II**. The dialogue box, as shown in figure 2.1, will appear. Then wait for installation instructions.



**Fig 2.1 Installation-Guidance window**

2. Enter the Installation window of Quick II, as shown in the figure 2.2.



**Fig 2.2 Installation-Introduction window**



If you click **NEXT** to enter the next step of installation, the User Name and Computer Name will be displayed, as shown in Fig. 2.3, and you can modify them. If you click **CANCEL**, the installation program will be terminated.

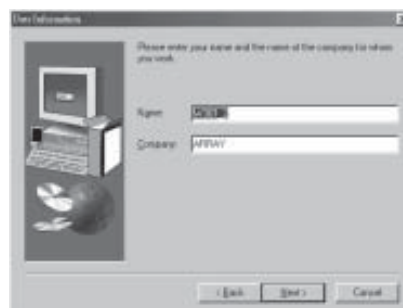

**Fig 2 . 3 User Name Setting Window**

3. Enter the Set Installation Path Setting dialogue Box, as shown in Fig.2.4. By clicking **BROWSE**, you can modify the current installation path (the original installation path is C:\ Program Files\ARRAY\Quick II) to your desired installation path:

If you click **NEXT**, it will enter the next step of installation and enter the Setup Type window for selecting installation type, as shown in Fig.2.5. Installation Type selecting window

If you click **BACK**, the previous installation window will appear, as shown in Fig.2.3.

If you click **CANCEL**, the installation program will be terminated.



**Fig 2 . 4 Installation Path Selection window**

4. Enter Setup Type window, as shown in Fig.2.5 and select your desired installation type.

If the **Typical** option is selected, the Quick II normal program will be installed.

If the **Compact** option is selected, the Quick II basic program will be installed.

If the **Custom** option is selected, the user will be allowed to select the Quick II program components.

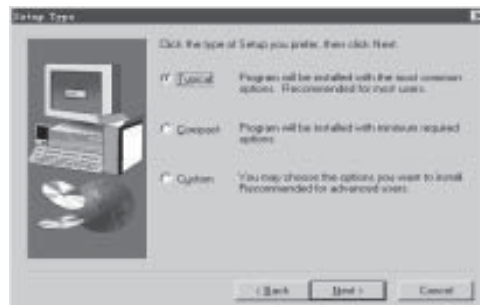

**Fig 2 . 5 Installation Type Selection window**

*Note: Selection of **Typical** option is recommended.*



5. If the **Custom** option is selected, it will enter Select Components window, as shown in Fig.2.6. Select and click the **element** you want to install, **I** will then appear in the corresponding box and the said element is selected and after being clicked again, it is cancelled (default of Quick II is to install all components when setup is completed).

Click **NEXT** to enter the next step of installation and the Setup Program Set Name dialogue box will appear, as shown in Fig.2.7.

Click **BACK**, the previous installation dialogue box will be displayed, as shown in Fig.2.5.

Click **CANCEL**, the installation program will be terminated.

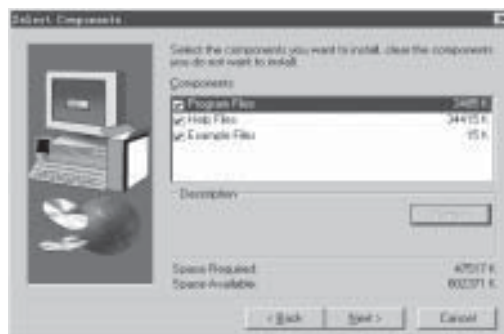

Fig 2 . 6 Installation Components Selection window

6. Set your desired program set name on the Set Up Program Set Name window as shown in Fig.2.7 . When setup is completed:

Click **NEXT**, installation of the program components will start, as shown in Fig.2.8.

Click **BACK**, the previous Selection window will be displayed to, as shown in Fig.2.6.

Click **CANCEL** and the installation program will be terminated.

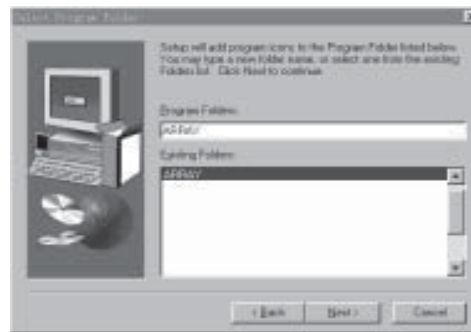

**Fig 2 . 7 Program Folder Selection window**

7. The installation program proceeds to the automated installation procedure. Click **CANCEL** if you want to terminate now.



**Fig 2 . 8 Quick II Installation window**

8. When the automated installation process is completed, the Setup Finished Window appears, as shown in Fig.2.9. Click **FINISH** to complete the installation process.



**Fig 2 . 9 Setup Finished window**



## 2 . 2 Uninstallation

There are two ways for the uninstallation of Quick II:

1. Remove from the program:

Under the Windows taskbar, click **>start >program>ARRAY** and select the said program folder.

Click **UNINSTALL** under the said program folder with the left mouse button, as shown in Fig. 2.10;

When a Confirm Uninstall dialogue box appears, click **Yes**.

When a Remove Window, as shown in Fig. 2.11, appears, removal can be done.

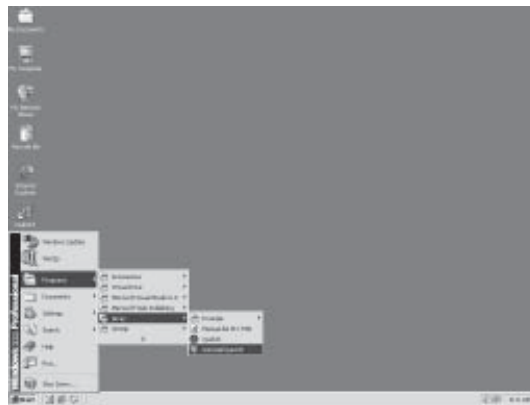

Fig 2 . 10 Uninstall window

This uninstallation method is more convenient for the users.

2. Remove from the console:

2.1 Under the Windows window, double click **My Computer** then open the **Control panel**, select **Add/Remove Program** on the Console Component and the Add/Remove Program dialogue box appears.



2.4 After selecting the ARRAY Quick II program folder in the said dialogue box, click **Add/Remove Program** and a dialogue box appears asking if you want to remove the program. Click **Yes** and the Remove window, as shown in Fig.2.10, appears.

2.5 Click **OK** to complete the removal and then close the Add/Remove Program window.



Fig 2 . 1 1 Remove window of Quick II

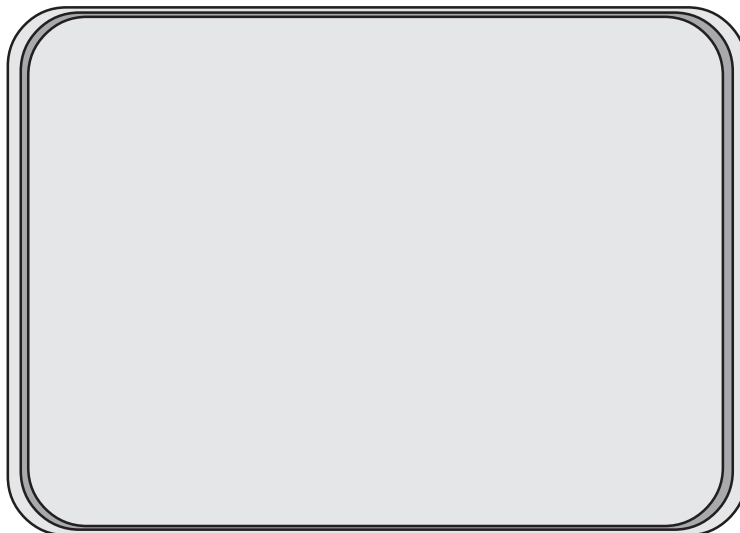



Chapter III Operation Instructions and Block Library

**3 . 1 Function Instructions**

When Quick II is used to edit FAB programs, some basic operations including files management, opening and closing of the Tool Bar and Status Bar access to Help information are completed by using pull-down menu under File, Controller, Communication, View, Option and Help. The Instruction Function list of.

Quick II is characterized by its flexibility and variation according to the main selection. It can be changed according to the current operation for convenience of your specific operations.

**3 . 1 . 1 File**

The instruction is mainly used for file management, including creation, opening, saving and printing of files.

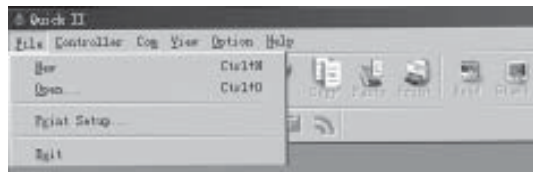

Fig 3.1 File Instructions Menu



| Instruction Name | Function                                       |
|------------------|--|
| New              | Open a new file                                |
| Open             | Open an old file                               |
| Close            | Close the current active Window                |
| Save             | Save a file                                    |
| Save As          | Save current file to a new path and a new file |
| Print            | Print a file                                   |
| Print Preview    | Preview the file printing result               |
| Setup Print      | Setup printing format                          |
| Exit             | Exit Quick II                                  |

### 3.1.2 Controller

The instruction is mainly used for reading programs from FAB. Start QuickII after its operating interface appears, click **Controller Function List**. The following is displayed:



Fig 3.2 Controller Instruction Menu

### 3.1.3 Communication

The instruction is mainly used for on-line setup of FAB with the upper computer



Fig 3.3 Communication Instruction Menu

## Chapter III Operation Instructions and Block Library



1. Configure communication: selection of communication mode and setup of communication port.
2. Stop communication: when it is not necessary for FAB to communicate with the upper computer, click this option to stop communication.

### 3.1.4 Display

This instruction is mainly used for selection of the opening/closing of the Field Simulation Graph window and Logical Diagram window as well as selection of various Tool Bars.

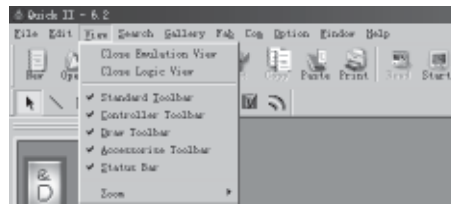

**Fig 3.4 Display Instruction Menu**

| Instruction name      | Function                           |
|-----------------------|------------------------------------|
| Close Simulation View | Close Field Simulation View window |
| Open Simulation View  | Open Field Simulation View window  |
| Close Logical View    | Close Logical View window          |
| Open Logical View     | Open Logical View window           |
| Standard Tool Bar     | Select Standard Tool Bar           |
| Controller Tool Bar   | Select Controller Tool Bar         |
| Draw Tool Bar         | Select Simulation view Tool Bar    |
| Accessories Tool Bar  | Select Block Library Tool Bar      |
| Status Bar            | Select Status Bar                  |
| Size zoom:            | Zoom in or zoom out the window     |



3.1.5 Options:

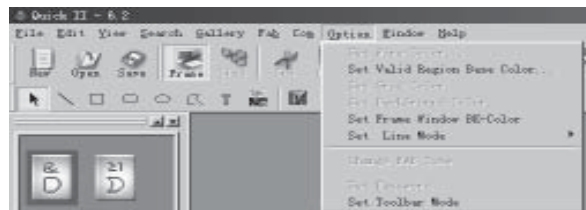

Fig 3.5 Options Instruction Menu

| Instruction                   | Function  |
|-------------------------------|---|
| Set Wire Colour               | Setup block on-line colour                          |
| Set Valid Regin Base Colour   | Setup Function Diagram significant draw zone colour |
| Set Grid Colour               | Setup Function Diagram grid point colour            |
| Setup Frame Windows BK-colour | Setup Window background colour                      |
| Setup Line Mode               | Setup block on-line types                           |
| Change FAB Time               | Modify FAB time                                     |
| Change FAB Address            | Setup FAB address                                   |
| Setup Password                | Setup programming                                   |
| Get FAB Address               | Get FAB Address                                     |
| Set Toolbar Mode              | Set Toolbar Mode                                    |
| Modify Output Status          | Modify Output Status                                |

3.1.6 Help:

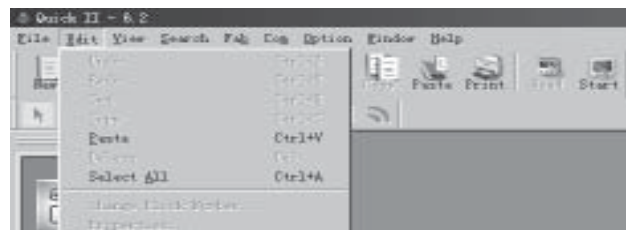

Fig 3.6 Access Help for Instruction Menu



- Contents: Contents and details of help.
- Search by subjects: Index of keywords.
- Use help: Instructions to help functions.
- About Quick II: Brief introduction to FAB.

### 3.1.7 Edit



**Fig 3.7 Edit Instruction Menu**

Undo: Undo the previous step operation and support consecutive operations.

Redo: Recover the contents undone by the previous step of operation and support consecutive operations.

Cut: Cut the contents in the area highlighted with the cursor.

Copy: Copy the contents highlighted with the cursor.

Paste: Paste the contents cut or copied.

Delete: Delete various graphic components.

Select all: Select all the contents in the current window editing box and setup the label.



### 3.1.8 Search

This instruction is mainly used for finding blocks in the function diagram that meet certain conditions.



**Fig 3.8 Search Instruction Menu**

Search by Label: find according to the comments for the blocks.

Search by Signal No: find according to the block number.

### 3.1.9 Image Library

This function is mainly used for providing various types of icons for you to plot the Field Simulation Graph.

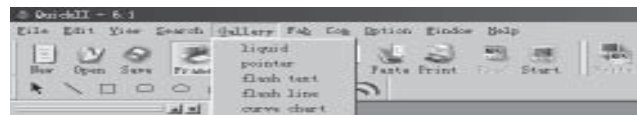

**Fig 3.9 Image Library Instruction Menu**

Liquid: storage Tank Icon.

Pointer: indicator Icon.

Flash Text: flashing Text Icon.

Flash line: streamline Icon.

Curve: curve Icon.

**3.1.10 FAB operation**

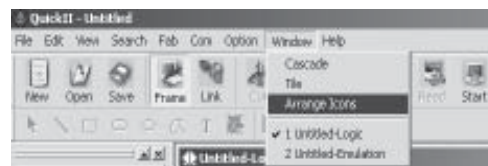

**Fig 3.10 Operation Instruction Menu**

| Instruction name     | Function   |
|----------------------|--|
| PC FAB               | write the program edited on the computer to FAB  |
| FAB PC               | read the program existing in FAB to the computer |
| Diagnosis of FAB     | detect the status of FAB                         |
| Simulation           | simulate FAB run                                 |
| Drive FAB            | start/stop FAB                                   |
| Read FAB Parameters  | upload FAB parameters                            |
| Write FAB Parameters | download FAB parameters                          |

**3.1.11 Windows**

This instruction is mainly used for the arranging of multiple opening windows. When more than two windows are opened, they can be arranged with this instruction;



**Fig 3.11 Windows Instruction Menu**



Cascade: Cascade sub-lists.

Tile: Display sub-lists in parallel.

Arrange: Arrange the sub-lists in the form of icons.

### 3.2 Tool Bar

After the Tool Bar is activated, the icon buttons of the Tool Bar will appear in the Edit window. You can use these icons directly without trying to locate them in the Function List. Tool Bar will let you complete your editing and drawing work faster and better.

#### 3.2.1 Standard Tool Bar

|                   |                       |   |                  |
|-------------------|-----------------------|---|------------------|
| Standard Tool Bar |                       |   |                  |
|                   | New                   |   | Copy             |
|                   | Open                  |   | Paste            |
|                   | Save                  |   | Print            |
|                   | Read Program from FAB |   | Block Link       |
|                   | Block Library Display |   | Start Simulation |
|                   | Cut                   | X | X                |



**3 . 2 . 2 Control Tool Bar**

|                  |                                  |  |                            |
|------------------|----------------------------------|--|----------------------------|
| Control Tool Bar |                                  |  |                            |
|                  | Write Program to FAB             |  | Run FAB                    |
|                  | Stop running FAB                 |  | Monitor FAB running status |
|                  | Diagnose FAB System Information. |  |                            |

**3 . 2 . 3 Draw Tool Bar for Field Simulation Graph**

By means of this Draw Bar, you can plot your system control site flow chart according to your actual control requirements and then you can view the operation conditions of all of the FABs during the said control process via communication with the FABs.

|                   |                          |  |                      |
|-------------------|--------------------------|--|----------------------|
| Standard Tool Bar |                          |  |                      |
|                   | Cancel Selection         |  | Draw Arbitrary Graph |
|                   | Draw Straight Line       |  | Input Text           |
|                   | Draw Square              |  | Insert Picture       |
|                   | Draw Round Corner Square |  | Insert Animation     |
|                   | Draw Circle              |  | Draw Bend            |



### 3.3 Block Library



Fig 3 . 12 Block Library

Separating various kinds of blocks: LOG represents logical blocks, which will be displayed when the button is clicked with the mouse. FUN represents the special function blocks, which will be displayed when the button is clicked. IN represents the input blocks, which will be displayed when the button is clicked. OUT represents the output blocks, which will be displayed when the button is clicked. Please refer to Chapter IV for details of different blocks.

#### 3 . 3 . 1 Block Library Operation

1. Click **LOG**, **FUN**, **IN**, **OUT** used for selecting block types under the Block Library , and corresponding blocks will be displayed in the Block Library Frame.
2. Move the cursor to the desired **block** and select it by clicking on it.
3. Click the corresponding **editing function block** in the Edit window and the selected block will be placed in the Logical Function Diagram.



**3 . 2 . 2 Control Tool Bar**

|                  |                                  |  |                            |
|------------------|----------------------------------|--|----------------------------|
| Control Tool Bar |                                  |  |                            |
|                  | Write Program to FAB             |  | Run FAB                    |
|                  | Stop running FAB                 |  | Monitor FAB running status |
|                  | Diagnose FAB System Information. |  |                            |

**3 . 2 . 3 Draw Tool Bar for Field Simulation Graph**

By means of this Draw Bar, you can plot your system control site flow chart according to your actual control requirements and then you can view the operation conditions of all of the FABs during the said control process via communication with the FABs.

|                   |                          |  |                      |
|-------------------|--------------------------|--|----------------------|
| Standard Tool Bar |                          |  |                      |
|                   | Cancel Selection         |  | Draw Arbitrary Graph |
|                   | Draw Straight Line       |  | Input Text           |
|                   | Draw Square              |  | Insert Picture       |
|                   | Draw Round Corner Square |  | Insert Animation     |
|                   | Draw Circle              |  | Draw Bend            |



3. Special Input: X represents empty, HI represents high potential and LO represents low potential. When the input is X, this terminal allows connection with a lead from another block. When the input is HI, no lead from any other block can be connected to this terminal and its status is always at high level. When the input is LO, this terminal allows connection with no lead from any other block and its status is always at low level.

**3.3.3.2 Setup of Special Properties**

Among the blocks of FAB, there are some special blocks that have special properties, including RS Relay Block, D/W Clock Switch, TEL Block, Broadcasting Play Block and Voice Recording Block. Setup of the properties of different special blocks is described as follows respectively.

1. Blocks with timers

All of the blocks with timers, such as MPLR, DPR, DDR, CPG, RPR and so on, have timing function. Their Block properties Setup dialogue box is as shown in Fig.3.14:



**Fig 3.14 Setting properties for blocks with Timers**

Time type: Three units, namely second, minute and hour, are available for selection;

Input time: Input the value for timing, and the time can be accurate to 0.01 second.

The properties of General Blocks shall be referred to for other settings.

2. Blocks with counters

Blocks with counters include UCN and DCN, whose Properties Setup dialogue box is as shown in Fig. 3.15:



**Fig. 3.15 Setting Properties for Blocks with Counters**

Number of counts: setup of the number of the counters, in the range of 1-999,999. The properties of General Blocks shall be referred to for other settings.

3. Properties of RS relay

The dialogue box of RS relay properties setting is as shown in fig. 3.16.



**Fig. 3.16 Setting Properties for RS Relay**

Special input: Please refer to general properties for X, HI and LO. P0 ~ P9 indicate the tone dial impulse input of 0 ~ 9 digit buttons on the telephone set. Please refer to general properties for other settings.



4. Property of TEL Block

The dialogue box is as shown in Fig. 3.17:

Phone code: Telephone number used for dial-up is keyed in here. The \*, # functions of the telephone are not supported. The length of the telephone number shall not be greater than 25 digits. Please refer to general properties for other settings.



Fig 3 . 17 Setting TEL Block Property

5. Properties of CW Clock Switch Block

The Setup dialogue box is as shown in Fig.3.18.

Clock setup: In this setting, the status of output can be regularly changed. Two options, Date style and Week style, are provided to meet the particular requirements of users.



Fig 3 . 18 Setting CW Clock Switch Block Properties

If Week Style is selected, and **Set Time** is clicked, the frame of setting time will be on and you can set up to 127 intervals for the time switch. Please note that you should set the time according to a time sequence. You can set a time point for CW block in QuickII very easily. Please see the following figure 3.

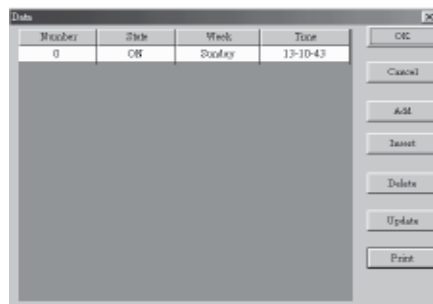

Fig. 3 . 19 Setting Clock Mode

In Fig. 3.19, there are some items such as Number, Start Week Time.

#### Time setting operations

**Add:** When you need to add a time, click **ADD** and a dialogue box will appear, as shown in Fig.3.20. Select the switch state ON/OFF and set the switch time. Then click **OK** and a time record is added.

*Note: They must be set in a time sequence.*

**Insert:** When you need to insert a time in the existing time setting combination, please click **INSERT** and a dialogue box will appear, as shown in Fig.3.20. Select the switch status **ON/OFF** and set the switch time. Then click **OK** and a time record is inserted.



**Fig. 3 . 20 Setting Time**

Delete: When you want to delete a time, put the cursor on the said time record and click **CANCEL**. When the Confirm Cancel frame appears, click **OK** to cancel the said time record.

Modify: When you want to modify a time, put the cursor on the said time record and click **MODIFY**. As a time setting frame, similar to that shown in Fig.3.20 appears, reset the time, click **OK** and the said time record is modified.

Print: When you want to print your set time on paper then click **PRINT**.

If DATE STYLE is selected, click **SETUP DATE**. As the Setup Date frame appears, the date and time can be set, as shown in Fig. 3.21.

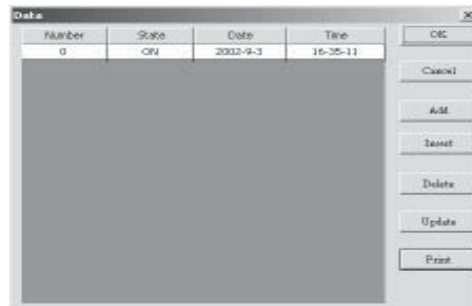

**Fig. 3 . 21 Setting Block Property for CW Clock**

## Chapter III Operation Instructions and Block Library

You can key in a new time or make changes through the keyboard in this box. Number, State, Date and Time item are set in the Setup Time box shown in Fig. 3.21.

The time setting operations are as follows:

**Add:** When you need to add a time, please click **ADD** and a dialogue box will appear, as shown in Fig. 3.21. Select the switch state **ON/OFF** and set the date and time of switch. Then click **OK** and a time record is added.

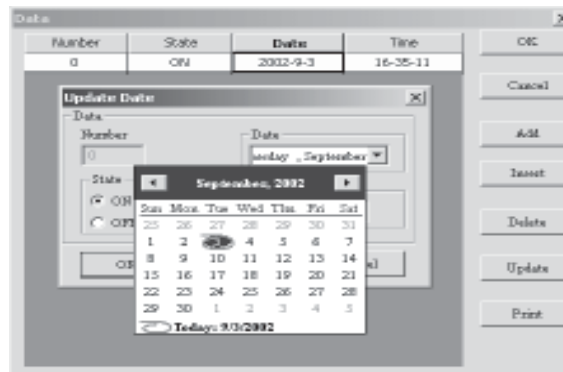

**Fig 3.22 Add A Time Record**

It should be pointed out that Quick II provides you with the best date setting method. You will have a permanent calendar chart appear, as shown in Fig. 3.22, only by clicking once the **Page Down** arrow on the right of the Date box. You may select whatever date you want to set on this permanent calendar and click **OK** to complete setting of the date. Therefore FAB can realize real-time control without any limitation.

**Insert:** When you need to insert a time in the existing time setup combination please put the cursor on the said time, click **INSERT** and a dialogue box will appear, as shown in Fig. 3.21. Select the switch status **ON/OFF** and set the time and date of switch. Then click **OK** to finish the setup.

**Delete:** When you want to cancel a time, put the cursor on the said time record and click **CANCEL**. As the Confirm Cancel frame appears,



Click **OK** to delete the time record.

**Modify:** When you want to modify a time, put the cursor on the said time record and click **MODIFY**. As a time setting frame, similar to that shown in Fig. 3.22, appears, reset the state, date and time, then click **OK** and the said time record is modified.

**Print:** When you want to print your set time on paper, what you need to do is simply click **PRINT**.

**Notes:**

(1) The time is arranged in an order from earlier to later and the time sequence shall be considered for adding or modifying any time record, for example: AM 9:00, AM 11:00, PM 3:00, PM 6:00, etc.

(2) In the case of multiple records, the said block will be divided into multiple blocks when it is written to FAB and you can view the number of blocks used by the current program in the State Bar of the Function Graph Edit Window.

(3) If the first time is set ON and the second time is set OFF, the two times share one common block, if two consecutive times are both set to ON or OFF, each of them should occupy a separate block.

### 6. Properties of Voice broadcasting and Recording Blocks

The Setup Properties dialogue box of Voice Broadcasting Block and Voice Record Block is as shown in Fig. 3.21. **Setting Output:** Set the ports for voice broadcasting and recording. The port here is a memory space oriented at voice storage. There 1 ~ 98 such ports in total. In addition, there is a No. 99 port (for record block), whose function is to clear all of the voice contents in No. 0 ~ 98 ports, so please be careful when using it.



Fig. 3 . 23 Setup the Properties of Voice broadcasting  
and Recording Blocks

7. Setup for Analog block.

The diagram of property of analog block AN is as fig 3.24.

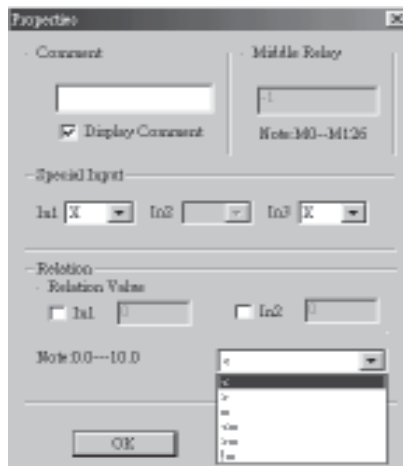

Fig 3 . 24 Setup of Property of Analog Block



The explanation of option listed in Fig 3.24 is as follows:

(1) comment: Users can add letters of explanation in this bar.

(2) Special input: HI, LO ,X, LM.

If X has been selected, this said port can be connected to Input port.

If LM has been selected, it means that this said port can be set to a fixed digital value. Please refer to (3) to know how to set the value.

(3) Relation Value

The range of LM is 0.0~10.0.

(4) Relation

It provides <, >, =, >=, <=, = 6 options. And this comparison block is for the comparison between input 1 and input 3.

For example.

When < has been selected,

if input 1 < input 3, then Q=1. if input 1 > input 3, then Q=0.





### Chapter IV Basic operations

This chapter introduces to you how to use Quick II to edit the Logical Function Diagram Program and draw the Field Environment Control Diagram, how to use it to simulate operation of the edited program and how to make the computer communicate with FAB so as to complete the writing of the program to FAB.

If you want to make a Function Diagram Program, you should first open a new empty file and put all the blocks required for satisfying the control requirements into the Edit Box. Then set the properties of different function blocks and link them up with lines according to their logical control relations, thus completing a Logical Function Diagram. Moreover, in order to help the user to find out if the edited function diagram can achieve the expected control effects, Quick II provides the user with a direct simulation function. You can run the simulation function either directly on the Function Diagram or on the Field Simulation Graph. In both cases, the detailed result of FAB running in accordance with the program can be observed, in the following, we will introduce QuickII with an example.

Example: using FAB to compose a multifunction switch for a staircase lighting system.

Control requirements:

1. Lighting is turned on upon pressing of the switch and automatically turned off after one minute.
2. Lighting flashes 5 seconds before automatically turning off.
3. Lighting is turned on upon twice pressing of the switch and maintained constantly on.
4. Lighting is turned off when the switch is pressed for 2 seconds and more.
5. Lighting is automatically turned on at 18:30 and off at 06:30 every day.



### 4.1 Open File

#### 4.1.1 Open a new file

Operating method

1. To open a new file, click **NEW** option under the Function List file or the **icon** in the Tool Bar, as shown in Fig. 4.1.



Fig. 4.1. Open a new file

2. Now a dialogue box will appear, as shown in Fig. 4.2:



Fig. 4.2. Options box for controller type

In the above figure, controller type options are provided in the left box and you can select your desired **FAB** type by clicking on it.

c.6 input 4 output: FAB with 6 input and 4 output

d.12 input 8 output: FAB with 12 input and 8 output

In the above figure, Simulation type options are provided in the right box and you can select your desired **simulation type** and click on it.

- a. Standard type: DRAW tool or other picture transferring method (e.g. transferring of BMP, TIF or other pictures) can be to plot Field Simulation Graph in this Simulation window, as shown in Fig. 4.3.

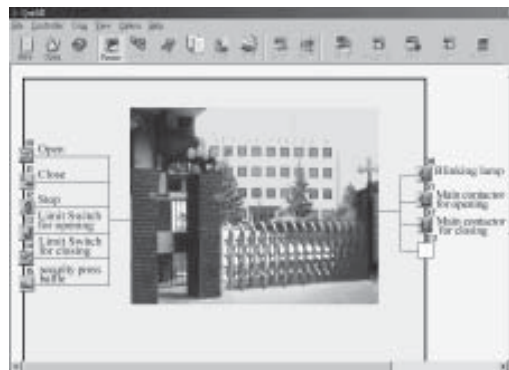

Fig. 4.3. Standard Simulation window

- b. Simple type: This Simulation window gives you a clear FAB outline diagram, with this you can view the status of each input and output after the simulation function is activated.

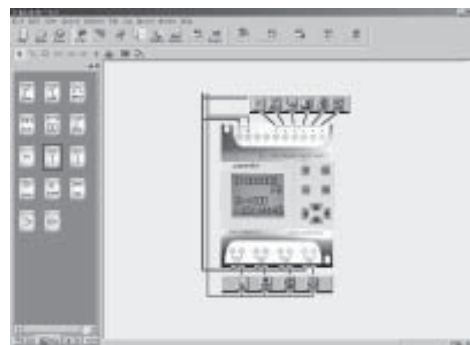

Fig 4.4 Simple Simulation window



3.(1). When the controller type and emulation type are selected, click **OK** to open a new group of Function Diagram Editing window and Control Field Simulation Graph Editing window, as shown in Fig.4.5.

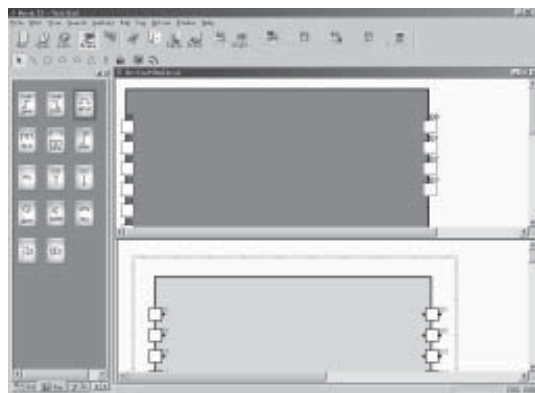

Fig. 4 . 5. Editing Window for new file

#### 4 . 1 . 2 Open an existing file

Operating methods:

1. To open a file, click the **OPEN** option under the Function List or the icon on the Tool Bar with the left mouse button, as shown in Fig. 4.6.



Fig. 4 . 6 open an existing file

2. Click to open the **dialogue box**, as shown in Fig 4.7

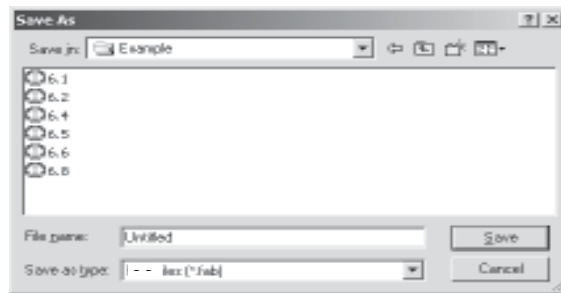

Fig. 4.7 Open an existing field dialogue box

3. Click the file to be opened and then the click **OPEN** and the file opens. You can execute modification, print or other operations of the file.

## 4.2 Edit Function Diagram Program

### 4.2.1 Place blocks

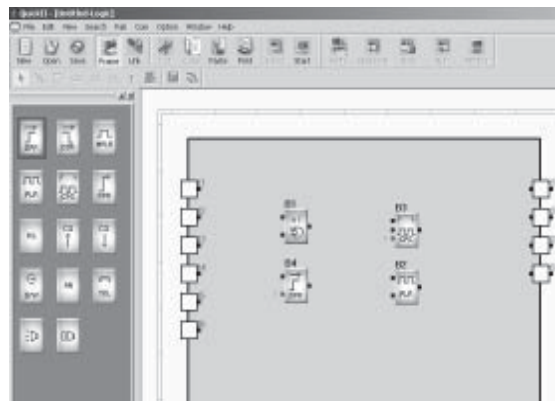

Fig. 4.8 Place blocks

## FAB Intelligent Controller

---



The desired block can be directly selected from the Block Library on the left of the Edit window and dropped in the Edit in box using the mouse.

Operating procedure:

1. Select the corresponding block group. To select the Basic Block click **LOG**; to select the Special Block, click **FUN**.
2. Select your desired block by clicking on it.
3. Move the cursor to the proper position in the Function Diagram Editing box and then click on this position, thus the **block** is placed.
4. Place all required blocks by repeating the above mentioned steps.

Example: There are totally 10 blocks required for the staircase lighting system, as shown in Fig. 4.9. Place all these 10 blocks in the Edit box.

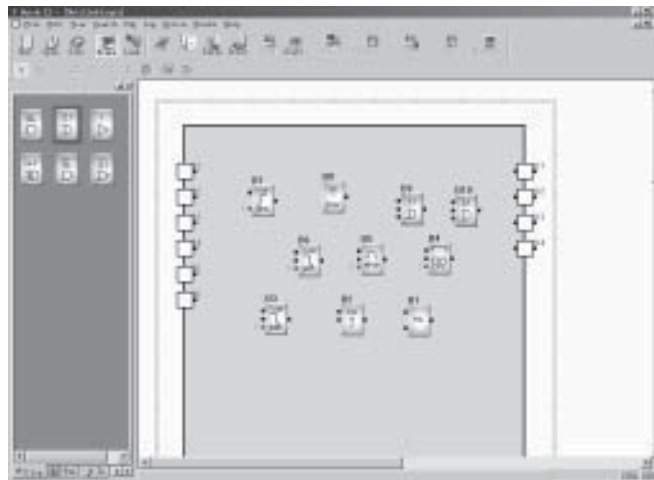

**Fig 4 . 9. Put the blocks required in the Edit box**

A brief description of the Block Library is given here:  
The Block Library stores all of the Basic Function Blocks, Special Function Blocks and I/O Blocks required for editing the Function Diagram. Click **LOG** under the Block Library to display the Basic Function Blocks; click **FUN** to display Special Function Blocks; click **IN** to display Input Blocks and **OUT** to display Output Blocks, as shown in Fig. 4.10(A), 4.10(B), 4.10(C) and 4.10(D).



Fig. 4.10(A) Special Function Blocks



Fig. 4.10.(B) Basic Function Blocks



Fig. 4.10(C) Input Function Blocks



Fig. 4.10.(D) Output Function Blocks



The graphs in the In Library and Out Library are only for you to select the input and output devices corresponding to the actual equipment, as shown in Fig. 4.8, so that the simulation run will have a more straight forward feeling, without any actual logical operation function.

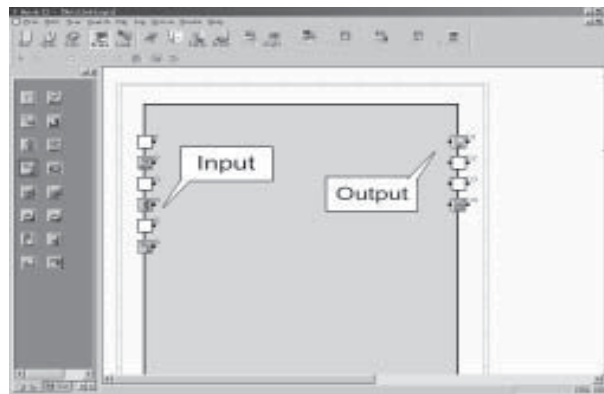

**Fig 4 . 11. Usage of Input and Output Function Blocks**

*Note: The graphs in the In Library can only be placed in the Input Ports but not in the Output Ports; and vice versa, the graphs in the Out Library cannot be place in the Input Ports.*

### **4.2.2 Edit block properties:**

Different blocks have different properties, which may be set according to the control requirements.

Operating methods:

1. Select a **function block** in the Function Diagram Editing box and click on it. An Edit Function List appears, as shown in Fig. 4.12. Then select **Properties** in the function list. Or you may double click the said **function block** directly.

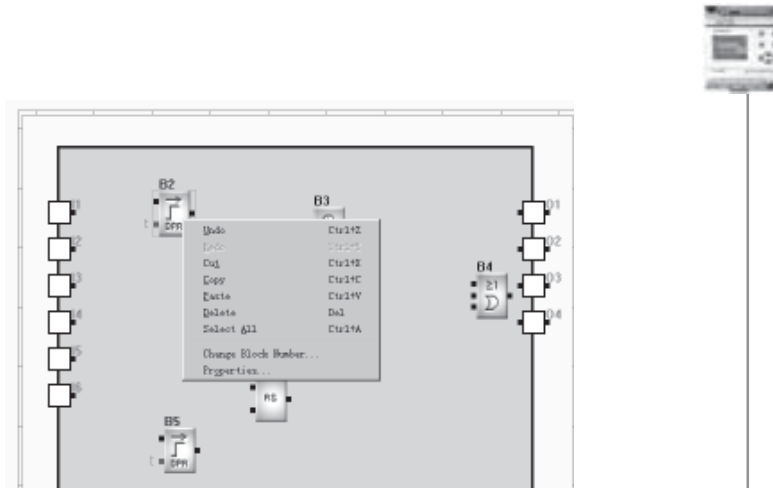

Fig. 4 . 12. Operation Menu of Blocks

2. A Setup Properties dialogue box appears, as shown in Fig. 4.13. Set the attributes according to your requirements.



Fig. 4 . 13 Dialogue box for setting block attributes

Comment: for filling in Comment String, no more than 20 characters.  
 Middle Relay: for setting the Middle Relay connected with the current block (the value range of the Middle Relay is 0 ~ 126).  
 Special Input: special input, in which X is empty, HI is high proportion and Lo is low proportion.



3. Click **OK** to complete the setup.
4. Set the properties of all blocks by repeating the above operating steps.

*Note: Different blocks have different properties setup, especially the Special Function blocks. Please refer to Chapter III, Section 3.4 for details.*

#### 4.2.3 Link:

After the blocks required for plotting the whole Function Diagram are placed and their properties are setup, it is necessary to establish links according to the logical control relations so as to make a complete function diagram. This software provides two link modes, i.e. automatic link and manual link.

Operating method

1. Click the **Set line mode** option under the Option Function List with the left mouse button and then click the **Auto** or **Manual** in the sub-option, as shown in Fig. 4.14. The default mode is automatic link mode.

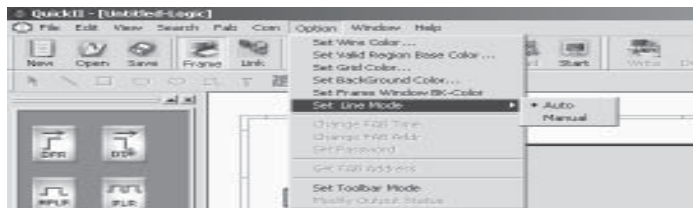



Fig. 4.14 Select the link mode

2. After the link mode is set up, click the icon  and the cursor changes to the shape of a pen, i.e. into the link status.
- 3 a. With automatic link selected in the first step, as the cursor is moved to the I/O ports of the blocks, its shape will change into a +, indicating that an **end point** can be determined through clicking the mouse. Now click the output **ports (or input ports)** of a block, requiring a link, then move to the input ports (or output ports) of the **next block** and click, thus the link is automatically established by the system.



When the shape of the mouse cursor changes into +, click on it. This method is suitable for the case in which the program is simple and the number of blocks is small.

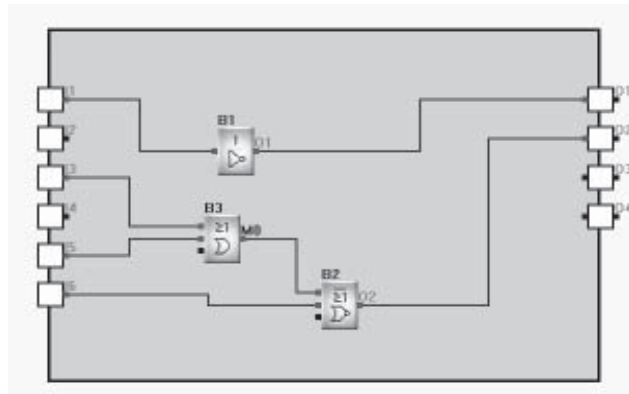

Fig 4 . 15 Link the line between blocks

3 b. Whether you select the manual link or automatic link in the first step, you can link the line as follows. Move the cursor to the start point of the connect line (it means that any input or output of a block), its shape will change into a + click and move the cursor to another **point**, and click again. At the ends of the lines, there will appear mark numbers, such as L5, L6 and so on, as shown in Fig 4.16.

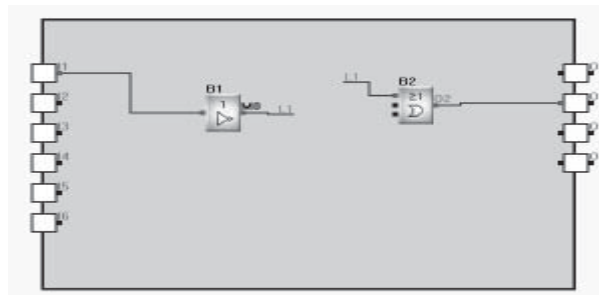

Fig 4 . 16



The operation is as follows:

Move the cursor to the **mark number** which needs change, click on it, Fig 4.17 will be shown. Select the change the line number, then Fig 4.18 will be shown. And you can modify the mark number in Fig 4.18.

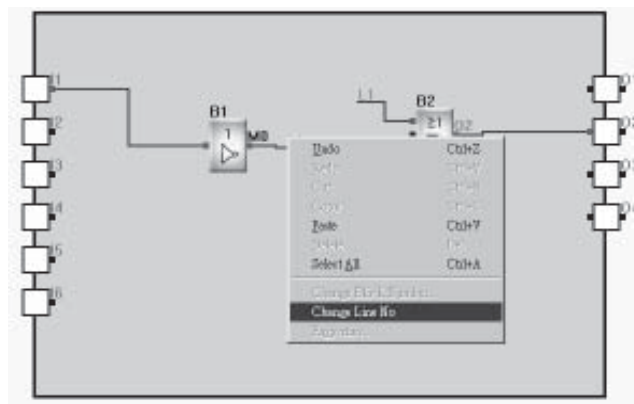

Fig 4 . 17 Change line No



Fig 4 . 18 Modify number

3 c. If the **manual link** is selected in the first step, click the **output port** of the former block, moving the mouse cursor according to your desired path, click at **turning**, thus forming a turning point, and go on moving the mouse cursor to the input port of the next block. And the link line can be set in the similar way.

4. Click again and the **link state** will be cancelled.



### 4 . 2 . 4 Move the link or block:

In case that there are a lot of links and blocks in your Function Diagram the diagram may be difficult to read due to so many crisscrossing lines, you can move some of the links or blocks to make the diagram tidy and easier to read.

Operating method:

1. Click the **link** or **block** to be moved and it will turn to a red colour.
2. Put the cursor on the **link** or **block** to be moved and drag it to the proper position.
3. Click again to complete the move.
4. Move all of the links and blocks that need to be moved with the same method to make the whole function diagram tidy and clear.

### 4 . 2 . 5 Delete block or link

When you want to delete unnecessary blocks or wrong links, the operation steps are as follows:

1. Select the link or block to be deleted.
2. Press the **Delete** key on the keyboard, or click the right mouse button and select the **Delete** option, thus the link or block is deleted.

### 4 . 2 . 6 Simulation operation

Quick II has an Simulation Run Function in addition to the editing of function diagram. When programming is completed, the Simulation Run Function may be activated for checking if the program meets your control requirements.

The operating method is as follows:

1. To activate simulation, Click the **Simulation** option under Instruction FAB Operation Menu and then click **Start**, as shown in Fig. 4.19, or directly click the **icon** in the Tool Bar. Now you can see the result of program running through the input and output status in the frame, as shown in Fig. 4.20.



**Fig. 4 . 19. Start the Simulation Instruction**

2. Please observe that your programs are running properly.
3. Click  again to terminate the simulation function.

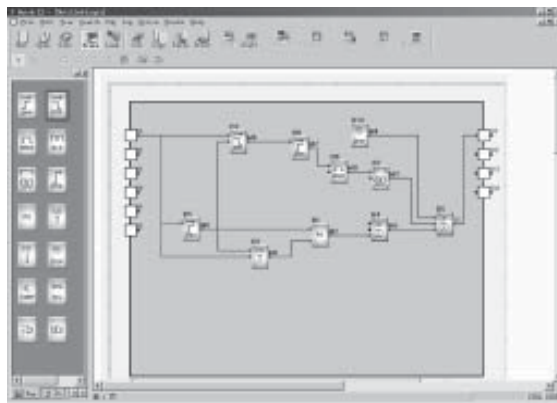

**Fig. 4 . 20. The Simulation operation of FAB Program**

In the above Simulation Graph, you can see the ON or OFF status of all inputs and outputs, as well as the input status and the current status of timing and counting of all blocks. So you can easily judge through this Simulation Function if the edited program meets the control requirements.

### 4.2.7 Save and print

Operating methods for files saving:

1. To save a program, click **Save** or **Save as** under the Function List with the left mouse button, as shown in Fig. 4.21, or click the **icon** on the Tool Bar;

2. The next dialogue box appears, as shown in Fig. 4.22, in which you can set the path and file name for save;
3. Click **Save** or **Save as** and save is completed.

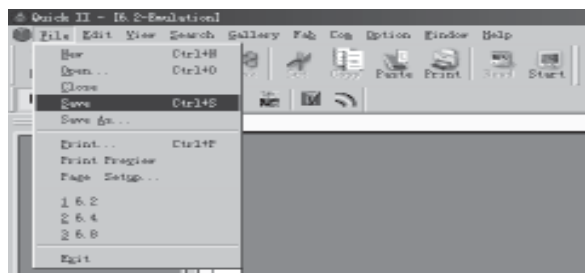

Fig. 4 . 21. Save file

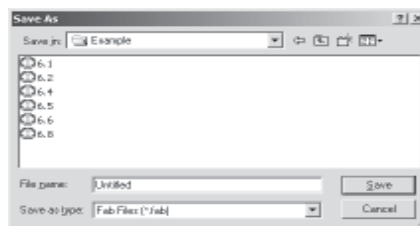

Fig. 4 . 22 Save the dialogue box

Operating methods for printing files:

1. Click the **Print** option under the File Menu.
2. A dialogue box appears, as shown in Fig. 4.23. Set your print requirements according to the prompt given on the frame.
3. Click **OK**.

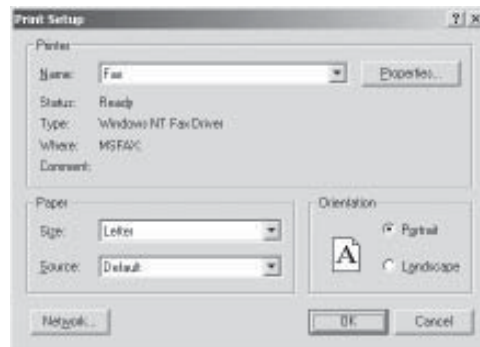

Fig. 4 . 23. Print file

#### 4.2.8 Write/Read

When the program is edited and has been proved through the simulation test to meet your control requirements, the Com. port of the computer can be connected with FAB directly through the programming interface or through a modem and the interface. In this way, remote and local communication between the computer and FAB will be realized so that programs can be uploaded to and downloaded from FAB. All these operations are very simple in Quick II.



Fig. 4 . 24. FAB Communication Connection Frame

Operating methods is as follows:

1. Click **Configuration** option under the Communication Instructions Menu, as shown in Fig. 4.25.

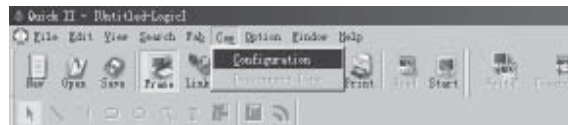

Fig. 4.2: Communication Configuration

2. A dialogue box appears, as shown in Fig. 4.26.



Fig. 4 . 26. Communication Configuration

3. Fill in the FAB address.
4. Setup the connection mode:
  - 1) For download, select modem mode by clicking on **Modem**.  
(Note: the modem here is the modem already installed in your Windows) and select the telephone number for dial-up.
  - 2) For local writing, select **Serial Port** and then the Serial Port **selection** by clicking on it to prepare the com port.
  - 3) Click **OK** to complete the setup.
  - 4) If the communication link is still not established, a Prompt window will pop up for you to reselect another modem or communication port



### 5. Write/Read

1) Click **PC FAB** or the **FAB PC** option under the FAB Operation Menu, as shown in Fig. 4.27. A Confirm Password window will appear, as shown in Fig. 4.28.



**Fig 4 . 27 Write/Read**

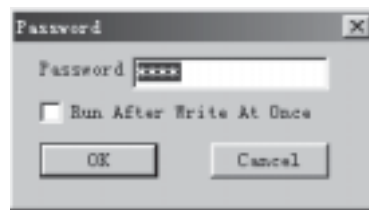

**Fig. 4 . 28. Password Confirm**

#### **Notes:**

1. The communication setup must be completed before communication can be established between the computer and FAB so as to complete the upload/download of the program.
2. During download from computer to FAB, if Run After Write At Once is selected, FAB will run the program,, after download, at once. If the option of not running at once is selected, or when the power supply to hardware is lost and then reconnected, click RUN under FAB, and FAB will start the program execution.



### 4.3 Plot Field Simulation Graph

When the Standard Simulation Edit Window of Quick II is in activated status, you can directly draw in the Edit box using the icons in the Draw Bar or insert BMP or animation Picture using BMP or Animation in the Tool Bar. This makes Quick II more convenient for you and you can easily draw a desired Field Simulation Graph with it. If the Draw Bar is not displayed, it can be selected from the Instructions Function List.

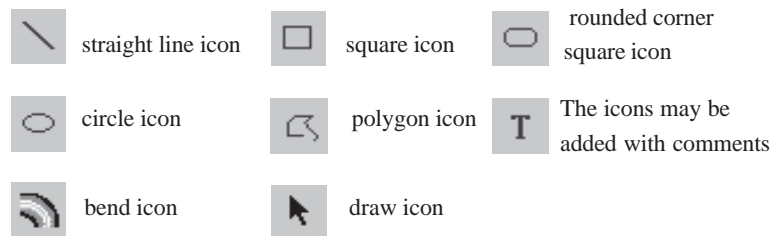

Fig 4 . 29 Draw Bar in Simulation Frame

#### 4.3.1 Plot with Draw Icons:

Operating method:

1. Click the Draw icon corresponding to the field environment in the Draw Bar:



2. Move the cursor into the **Editing box**, hold the left mouse button down and drag the mouse to make the graph in the desired nature and size;

3. Click to **fix the graph**;



4. If it is necessary to move a graph or change its shape and size, select the **graph to be changed** and drag the mouse cursor to move the graph or click the **boundary of the graph** to zoom it.



#### 4.3.2 Insert Graph File directly

 is the icon for inserting a BMP File and  is the icon for inserting an Animation File.

Operating methods:

1. Select the icon  or .
2. Move the cursor into the editing box.
3. Click the left mouse button and an **Insert dialogue box** appears, as shown in Fig. 4.2:

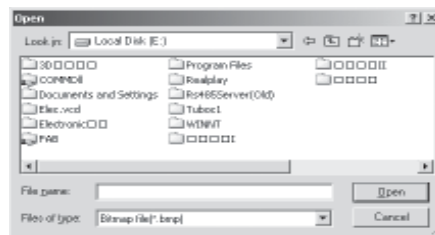

Fig. 4.30. Insert BMP file

4. Select the path for and name of the Picture File to be inserted.
5. Click **Open Old File** to insert the said picture into the Simulation Graph editing box. Draw a complete Field Simulation Graph as shown in Fig. 4.31.

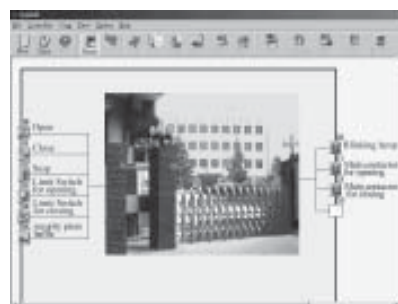

Fig. 4.31 Standard Field Simulation Graph



## FAB-SCADA SOFTWARE

## CHAPTER 1 Introduction to the FAB-Scada System

### 1.1 General Introduction

FAB-Scada System is a system for Supervisory Control and Data Acquisition. It can collect digital and analog inputs from the field, carry out local or remote real-time control over the fields controlled by the FAB Controller (FAB) and provide, with the necessary resource, a management function.

FAB-Scada System Software is an easily operated and widely used industrial software for the utilisation of the network function of the FAB. It uses a FAB as the terminal control unit and it is a network system that collectively carries out the real-time data acquisition and supervisory control over a group of FAB's that separately carry out the auto-control task. With the FAB-Scada System Software, you can build a complete supervisory management system from PC's to FAB's for the control, according to the specific field environments and requirements, of a system.

FAB has the basic functions of a common PLC, FAB also has some special additional features: real-time clock function, input and transmission of analog signals, voice function, network and remote supervisory control function and so on. In this manual we will introduce you to how to use a network of FAB's and ancillary devices together with the FAB-Scada System.

### 1.2 Network Structure of FAB

There are two methods of supervisory control system which uses FAB as the site-control unit. You may build the following two supervisory control systems according to different control requirements.

Scheme 1: Network of RS 485 Buses (As in Fig. 1-1), this is suitable for a control system of small scale and short distance (within a distance of 1.2 kilometres).

Scheme 2: Network System of Supervisory control by use of a Modem (As in Fig. 1-2). This network is suitable for a control system of a small scale distributed over a long distance.

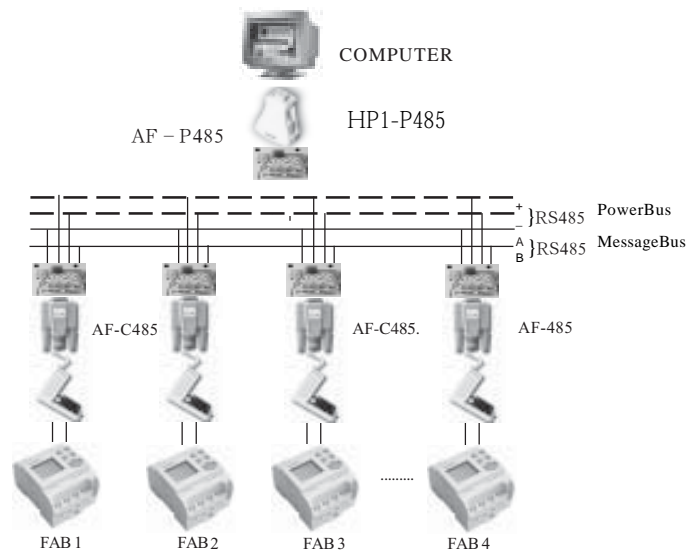

Fig. 1-1 Serial Communication Using RS485

**1.2.1 Network of RS485 Buses**

The preceding diagram is the schematic diagram of the control system using FAB as the field-control unit. For FAB, which has a communication port, it is convenient to use this method via RS485 buses.

The upper device, a computer, communicates with FAB's using a computer serial port via RS485 buses. In this system, a computer port can communicate with up to 255 FABs. Expanded, a computer can communicate with an extended number of FABs.

This system is a small structure and can be easily built with other devices, machines, etc., it also greatly simplifies the DCS system. Compared with other field bus networks, it can provide a clear field supervisory diagram from the top to the bottom of the system. It can also provide a very cost effective solution for you. Building this form of control network only needs the installation of communication adaptors type A F - C232, AF-P485 or AF-C485.

*Note: This system is suitable for small scale control with a spread not greater than 1.2 kilometres, for example modern residential quarters, factories and so on.*

**1.2.2 Network System for Remote Control via a Modem**

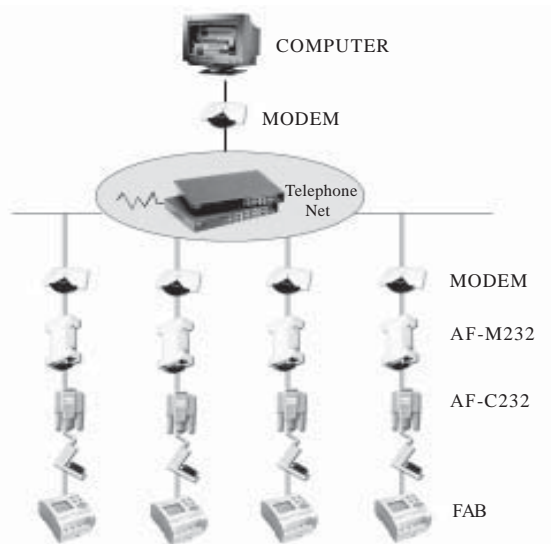

**Fig. 1-2 Remote control Using Modem**

You may need to carry out long distance (no limit via a touch tone telephone network) supervisory control, whether using one FAB or many FABs. This is achieved by using the design method illustrated in the above figure by the use of a telephone network and a Modem.

When building this supervisory control network, you will need to equip it with an AF-M232, AF-C232 and a standard Modem together with telephone network, also to select an AF-MUL voice module. The features of this kind of monitoring network is as follows:

1. PC, the upper device, scans the FAB control unit at the control end in sequence, to achieve real-time control.
2. When achieving the long distance real-time control using a FAB, the PC will provide the application function in the down-loading and subsequent changing (as required) of the programs for each of the FABs in the network.

3. Being set to monitor the breakdown status of a station, the FAB, being the lower device, will give alarm signals to the computer, being the upper device, if a breakdown is taking place. When the network is equipped with an AF-MUL voice module, it will broadcast a local audible voice alarm and dial a preset telephone number to confirm the alarm status to the predetermined location.

**1.3 More Detailed Introduction to the FAB-Scada System**

FAB-Scada System provides the users with a friendly secondary development interface and makes it possible for you to build a control system as required. It may be the collective control of intelligent residential quarters or of computers dispersed in cities.

The display in Fig. 1-3 is the FAB-Scada System control displaying the main tableau. In this tableau, you only need to click the mouse and invoke the control flow diagram to monitor the field data and state of different control network spots, observe the resources, print the report and so on.

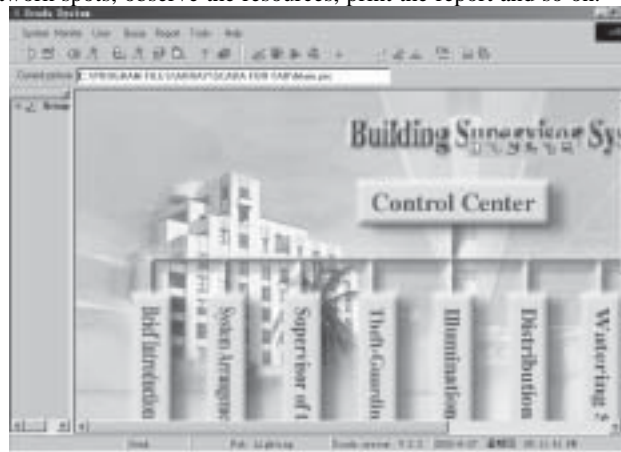

**Fig. 1-3 Main Diagram of FAB-Scada**

In order to make it possible for you to build your own control system, FAB-Scada Software provides you with a friendly secondary development interface as shown in Fig. 1-4. In this interface you may freely build the network system of choice by using the draw tools.

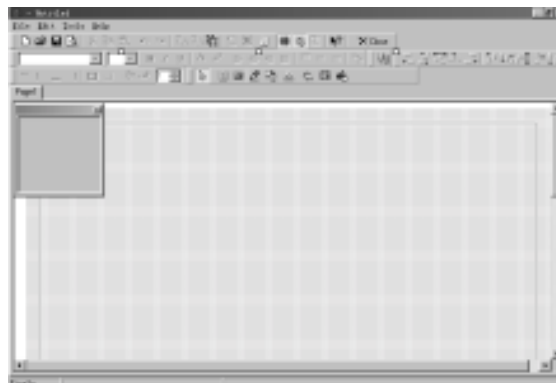

**Fig. 1-4 Drawing Interface**

## Chapter 2 Installation of FAB-Scada System

FAB-Scada System can be used in the environment of WIN9X/WINNT/WIN2000 and so on and the hardware requirements are computer based with a processor above 586. A knowledge of the Microsoft Windows operating systems is assumed.

Detailed installation steps are as follows:

Step 1. Insert the **CDROM disc** into the disc drive. The installation system will run automatically and the following installation interface will appear.

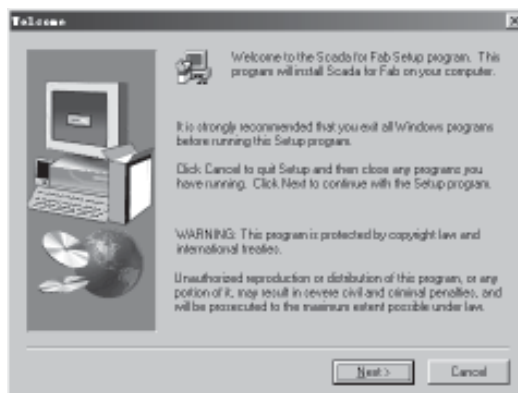

Fig. 2-1 Installation Interface 1

Step2. Click **Next** to continue in Fig. 2-2. Key in the users information and then click **Next** again to continue in Fig. 2-3.

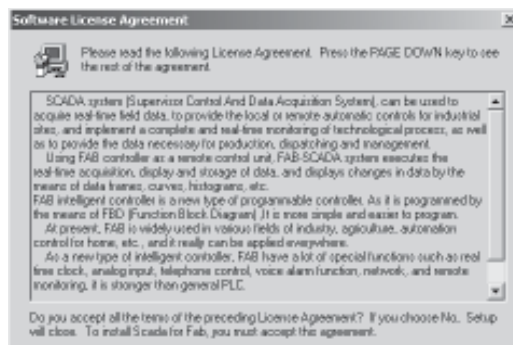

Fig. 2-2 Installation Interface 2



Fig. 2-3 Installation Interface 3

Step 3. Setup the destination directory. Click **Browse** and then you can set up the destination directory. The system default destination directory is C:\Program Files\ARRAY\Scada For FAB.

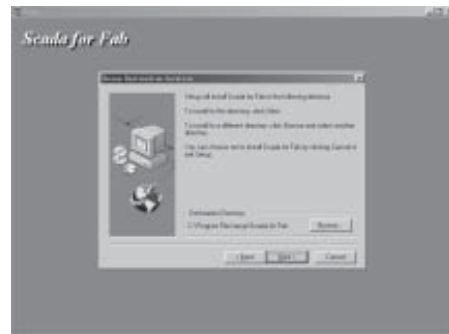

Fig. 2-4 Installation Interface 4

Step 4. Setup Installation/Deletion Folders. (This item will appear in the function menu of Control Panel Add/Delete). You select, for example, **Scada for FAB** Completing the setup, click **Next** to continue in Fig. 2-5.

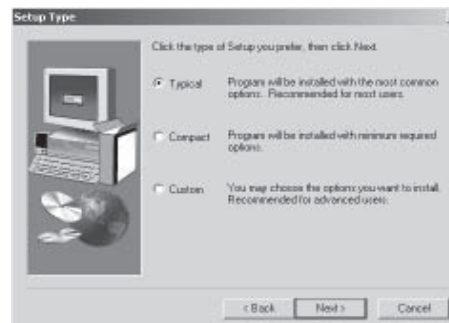
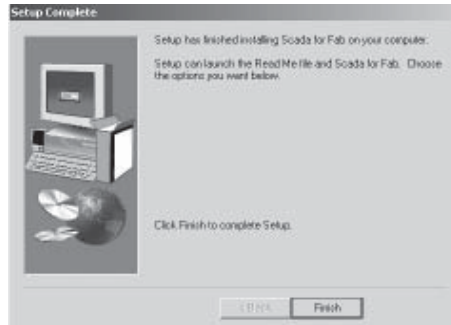

Fig. 2-5 Installation Interface 5

Step 5. In Fig. 2-6, if you want to run the system immediately, select **Yes** to launch the program. If you don't want to run the system immediately then click **Finish**.



**Fig. 2-6 Installation Interface 6**

Step 6. Run FAB-Scada System. Select **Start> Program>Scada for FAB** and then click the **quick icon**.

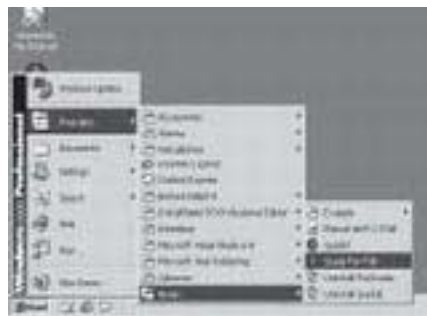
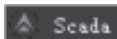

**Fig. 2-7 Run FAB-Scada System**

Step7. Uninstall the system. This task needs to be carried out when the system is not needed or the system does not work normally. (Certainly, data needs to be backed up before the software is uninstalled. We will explain how to backup the programme in the following chapters). Then use add and remove programs under the system Control Panel, Fig.2-8, highlight **Scada for FAB** and then click **Add/Remove** and follow the prompts.

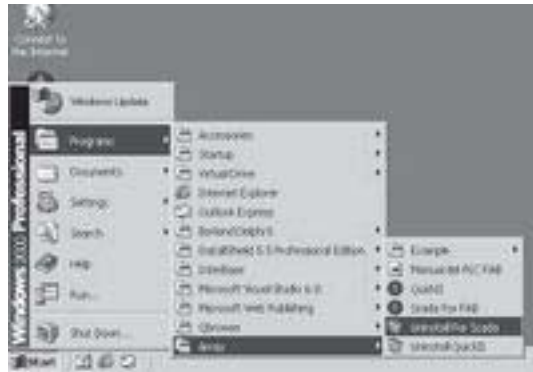

Fig. 2-8 Uninstallation System 1



Fig. 2-9 Uninstallation System 2



## Chapter 3 Operation Instructions and Quick icons

### 3.1 Instructions and Icons in the Control Interface

In the menu bar of FAB-Scada run time system, there are some main operating instructions such as System, Monitor, User, Query, Report, Tools and Help. They are used to complete the configuration of the system and to control and monitor the values. We will introduce their functions one by one in the following text and tableau.

#### 3.1.1 System (Operation Instructions for System Management)



Fig. 3-1 System instruction

Set FAB time: set the current time of the computer to the FABs and this is equivalent to the quick icon.

Printer: print the report and this is equivalent to the quick icon

Deploy: when you edit a control system, you can package all of the diagrams under the FAB-Scada directory and related files into one engineering file and then deploy it to other computers. When the engineering files are transferred to other computers the installation of all of the diagrams and equipping files under the FAB Scada system environment is complete. This feature is equivalent to the quick icon.

Exit: close the FAB-Scada system and this is equivalent to the quick icon.

#### 3.1.2 Monitor (Operation Instructions for Monitor Setup)

Operation menu for Monitor Setup include Clear alarm, Draw tools, Station Design, Add/Delete FAB, Design FAB, Communication and Batch Control.

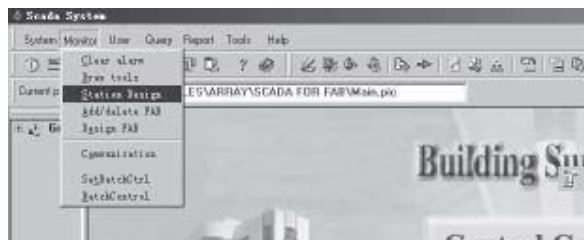





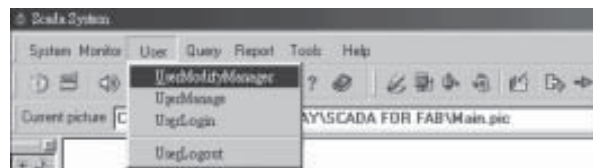

Fig. 3-2 Operation Instructions for Monitor Setup

- Clear alarm: Clear alarm information and reset and is equivalent to the quick icon. 
- Draw tools: Open or close the drawing interface and is equivalent to the quick icon. 
- Station design: design a station and is equivalent to the quick icon. 
- Add/delete FAB: setup an specified number of FAB controllers in a station and is equivalent to the quick icon 
- Design FAB: design each input/output of FAB and is equivalent to the quick icon. 
- Communication: display communication data.
- Set Batch Ctrl: set Batch Process. Being used for the lifetime-control of the ON/OFF of all the FAB output.  
(To complete all of the actions in one step.)
- Batch Control: execute the Batch Process.

**3.1.3 User (Users-Management Instructions)**

Users-Management menu is for the management of the operator setup of the whole system, including User Modify Manager, User Manage, User Login and User Logout.



**Fig. 3-3 Users instruction**

- User Modify Manager:change the name and password of the system manager. The default name is Manager and the default password is '0001'
- User Manage: add normal users after the system manager login.
- User Login: users use this menu item to login FAB Scada system.
- User Logout: users use this menu item to logout FAB Scada system.

**3.1.4 Query (Query Instructions of the System)**

In FAB-Scada System, the menus may be used to query the history records of all measurement values, line diagrams and so on.



**Fig. 3-4 Query instruction**

History: Show the history data of a telemetry signal (analog value).

SOE: Show all the history data of the switch state (digital value).

### 3.1.5 Report

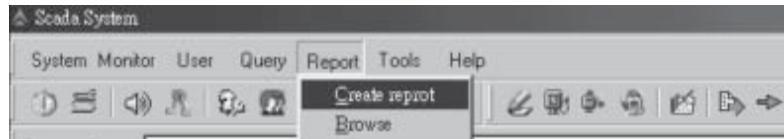

Fig. 3-5

Create Report: start a new report.

Browse: browse the report.

### 3.1.6 Tools

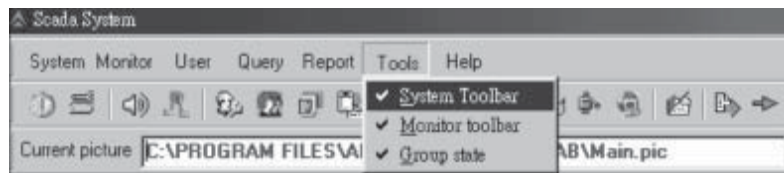

Fig. 3-6 Tools instruction

System Toolbar: open/Close the System Toolbar.

Monitor Toolbar: open/Close the Monitor Toolbar.

Group state: the state of the group.

### 3.1.7 Help

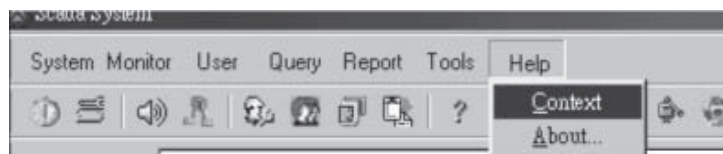



Fig. 3-7 Help instruction

Context: the context help of FAB-Scada.

About: brief introduction to FAB-Scada.

### 3.2 Operation Instructions and Quick icons in the Drawing Interface

Starting FAB-Scada system, the monitor interface will be displayed first. Users needs to login to enter the system, and click **Monitor/Draw Tools** or the **quick icon**  to enter the drawing interface. The drawing interface is mainly used to edit the site control diagram, connect the site material objects in different control fields and assign physical content to them.

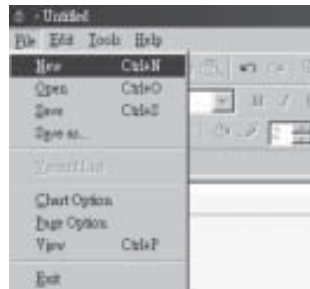



Fig. 3-8 File instruction

#### 3.2.1 File (Files management)

**New:** Open a new drawing page, use the **quick icon**  or click **Ctrl+N**.

**Open:** open an existing drawing page, use the **quick icon**  or click **Ctrl+O**.

**Save:** save the edited drawing page, use the **quick icon**  or click **Ctrl+S**. The default saving directory is .\FAB-Scada.

***Note:** Please do not change the saving directory randomly. For the file to be invoked by the system successfully, the file must be saved in this directory.*

**Save as:** change the directory of the existing edited page and save it.

**View:** view the edited drawing diagrams.

**Exit.** exit the drawing interface.

#### 3.2.2 Edit

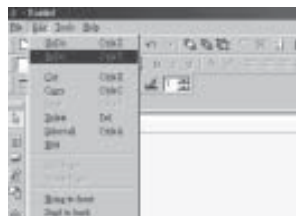

Fig. 3-9 Edit instruction

Undo: undo the editing contents of the previous step.

Redo: clear the undo.

Cut: cut the selected contents.

Copy: copy the selected contents.

Paste: paste the copied or cut contents.

Delete: delete the selected contents.

Select all: select the contents of the whole page.

Bring to front: move to the upper layer.

Send to back: move to the lower layer.

### 3.2.3 Tools

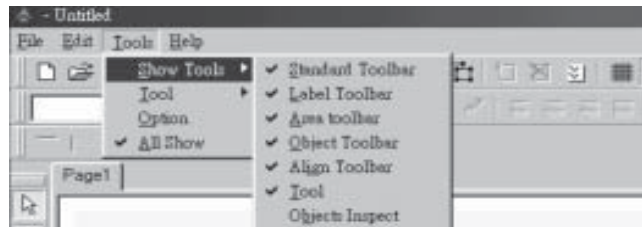

Fig. 3-10 Show tools instruction

Show Tools: open/close Toolbars.

Tool: select the tools.

Show all: open all Toolbars.

### 3.2.4 Help

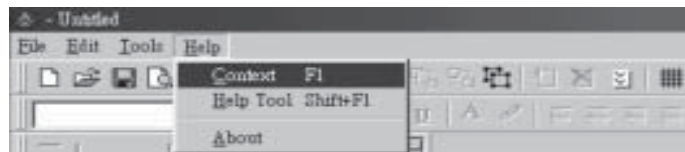

Fig. 3-11 Help instruction

Context: the context help.

Help Tool: the Help Tools.

About: introduction to FAB-Scada versions.



## Chapter 4 Build a Supervisory Control System

In previous chapters we have introduced the FAB-Scada System Software, this is an industrial software using FAB intelligent controllers as the field control unit. On the basis of FAB-Scada System software, you can build a supervisory control system from computer to FAB according to the specific field environment and control requirements.

To build a complete control system, a Station has to be designed first, then the necessary FABs will be setup. After this the control input/output signals relevant to each input/output port and relevant field flow diagram will need to be setup. The system diagram will be linked to corresponding field control point one by one, thus the system control shall be realised. In order to realise the above procedures, FAB-Scada System Software provides all necessary operation instructions, these instructions will be introduced in detail in the following text and tableau.

For example, you are about to build a control system for a group of residential quarters. The group of residential quarter comprise 100 households, each of which needs a FAB. Each household uses a FAB as the field controller for the theft monitor, the gas leakage monitor, the room illumination monitor, the air-conditioning control, the exhaust fan and the access doors, etc. In the central control room, a computer is set up for real-time control of all FABs and thus the state of all of the monitored households. If there is an alarm situation occurring in a household, the relevant FAB will automatically initiate an alarm and also send the prerecorded emergency call to the preset telephone number.

We can select the networking methods of Scheme 1, communicating via RS485 buses, to complete real time control in this example.

### 4.1 Station design

**Explanations:** Generally speaking, a Station is formed by a computer and FABs (1~255). The computer is for the human-machine interface, and for carrying out real time control over FABs, local or remote, via an RS485 network or telephone line connection via a Modem to realise real time control over various input/output equipment.

The operation for designing a new system is as follows: (You should login first)

1. Click **Monitor>Station Design** to open **Set Station** dialog box or click the **quick icon** 

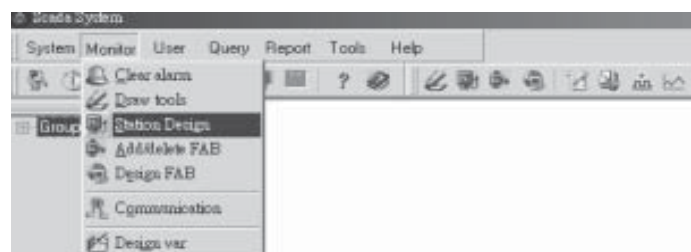

Fig. 4-1 Monitor Instruction Menu

2. A station design dialogue box will automatically appear in the system, as shown in Fig. 4-2.



**Fig. 4-2 Station Designing dialogue box**

3. If you design a Station for the first time, click **Create** in the right of Fig. 4-2 to enter station setup dialogue box, as shown in Fig.4-3. If your system already has a designed station, then click **Modify** to modify the existing station and enter station setup dialogue box. Or click **Delete** first to delete the existing station and then click **Create** to enter the Station Setup dialogue box.



**Fig. 4-3 Station Setup dialogue box**

The field contents are as follows:

| Field Name   | Content                      | Remarks                      |
|--------------|------------------------------|------------------------------|
| Station Name | Name of the Station          | Sun Garden #1 in the example |
| Comm         | COM Series Connection Port   | COM1 in the example          |
| Save (Sec)   | Interval of Resources Saving | Preset value is 300 second   |
| Use Modem    | Use Modem or Not             | Not selected in the example  |

4. In the Station Setup dialogue box, as shown in Fig. 4-3, the Station Name and Comm must be entered and cannot have duplicates, it must be unique. When editing is complete, click **OK** , this finishes the setup of the Station Name and the Communication method, then the dialog box, as shown in Fig. 4-4 will appear.



**Fig. 4-4 Dialogue box for Definition and Modification of the Station name and Driving Method**

5. Select **OK** and finish the Station design, and the Station Name being Station and Communication being COM2. These does not apply if **Create** is selected. If **Modify** is selected, you can modify the Station Name. And if **Delete** is selected, the existing station is deleted.

*Note: The FABs using the same COM port are considered to be one station. When designing a station, the COMs related to a station should be identical. For upgrade of an existing system, with the expansion or reduction of the system management and the changes of the communication methods, stations can be added or deleted using **Add/Delete**.*

#### 4.2 Add/Delete FAB

There are 100 FAB control units in this example. If you need to add a FAB in the same Station, you can build them one by one. The operation is as follows:

1. Click **Monitor>Add/delete FAB** per Fig. 4-5, or click the **quick icon**  in the Toolbar, the dialogue box, as shown in Fig. 4-6 will appear.

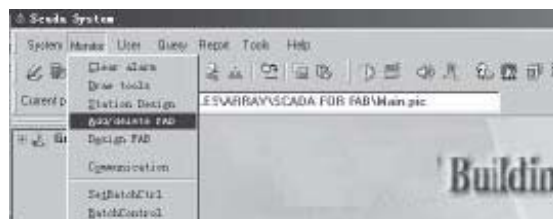

**Fig. 4-5 Operation Instructions of Add/Delete FAB**

2. In the dialogue box, as shown in Fig. 4-6, the Station Name is displayed at the upper left hand corner. If you click **Add**, you can add a FAB in the station. If you click **Delete**, you can delete a FAB in the Station. If you click **Modify**, you can modify the selected FAB.

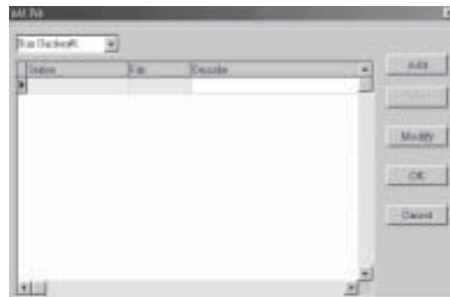

Fig. 4-6 Adding or Modifying FABs Dialogue box 1

2.1 Click **Add** and enter the next Dialogue box as in Fig. 4-7. Enter the FAB name, Address, Type and Mark.

*Note: The Addresses should be unique and be consistent with the FAB name. For example, for the first FAB, the name is FAB 1, the Address is 0, the Type is 20-point type and the Mark is 1. Other parameters cannot be modified at the same time.*



Fig. 4-7 Adding or Modifying FABs Dialogue box 2

| Field Name    | Content                                  | Remarks                       |
|---------------|--|-------------------------------|
| FAB name      | The Name of the Controller               | SGB001                        |
| Description   | Description and Explanation              | No 01 building of Sun Garden1 |
| Mark          | Using Marks (0-Closing 1-Opening)        |                               |
| FAB address   | The Address of the FAB                   | The same as the FAB           |
| Address       |  |                               |
| FAB Type      | The Type of FAB (10 (point), 20 (point)) |                               |
| Analog        | Tele-metering Data                       |                               |
| Digital       | Tele-communicating Data                  |                               |
| Pulse         | Tele-pulsating Data                      | Not yet available             |
| Protocol Type | The Type of the Protocol                 | Not used                      |
| Enabled       | Being Used                               |                               |
| Phone Code    | The Telephone Number                     |                               |

2.2 Click **OK** to end the setting up of FAB 1, as in Fig. 4-8.

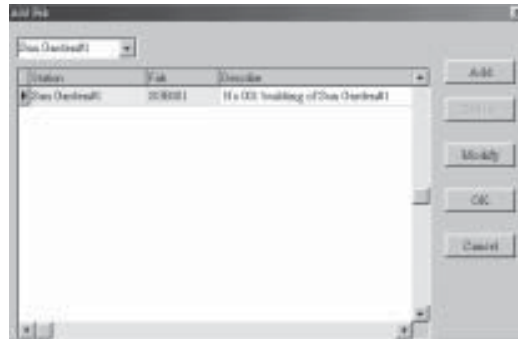

**Fig. 4-8 The Controllers Adding Competition Dialogue box**

2.3 Repeat the above operations and add 100 controllers into the Station Sun Garden #1 one by one as in Fig. 4-9.

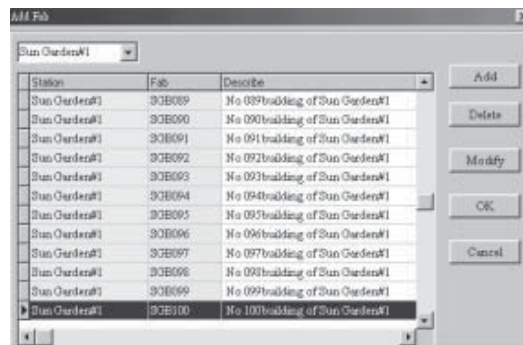
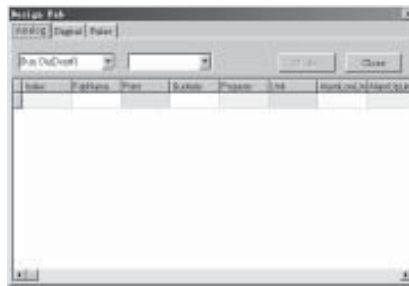

**Fig. 4-9 Completing the Add of 100 Controllers**

### 4.3 Define the FAB I/O Port

After building the Station and having added corresponding FABs, you need to define the I/O ports of the FABs to make them consistent with the input signals both in the environment and the field equipment. In the system, the default values of I/O ports are: Digital input point~Digital input point10. If they are inconvenient in actual use. You then need to modify the definition of the FAB I/O port. The detailed operations are as follows:

Step 1. Click **Monitor>Design FAB** or the **quick icon**  , the system will display the FAB definition interface, as in Fig. 4-10.



**Fig. 4-10 FAB Defining Dialogue box**

There are two types of I/O Port signals:

- (1). Tele-metering: the input simulating value of the FAB.
- (2). Tele-communicating: the ON/OFF state of the FAB.

The setup of the three I/O types are determined according to the demands of the users. The dialogue frames for the setup of the three types signals: tele-communicating, tele-metering, tele-pulsating are as follows:

A. Digital Points properties definition dialogue box

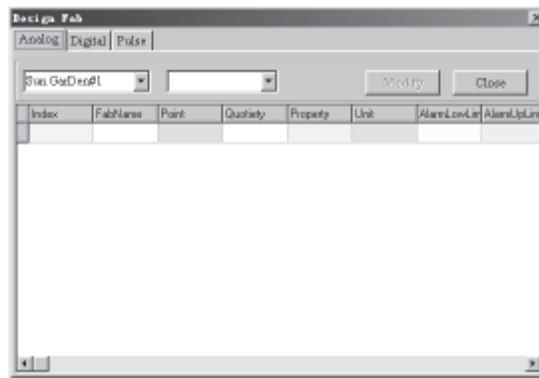

**Fig. 4-10.1 Tele-communicating Point Properties Definition Dialogue box**

The content of each rail is as follows:

| Rail Name      | Content                | Remarks            |
|----------------|------------------------|--------------------|
| Point          | Defining the I/O Port  |                    |
| Alarm Level    | The Level of the Alarm |                    |
| Property       | Property               |                    |
| Explain        | Explanation            |                    |
| Alarm          | Alarm or Not           | Not                |
| Control        | Controllable or Not    |                    |
| Sound          | Sound Alarm or Not     |                    |
| Normal Open    | Always Being Open      | Select one of them |
| Normal Close   | Always Being Closed    |                    |
| From off to on | From Closed to Open    | Select one of them |
| From on to off | From Open to Closed    |                    |
| Both           | Select the Both States |                    |
| Normal Colour  | The Normal Colour      |                    |
| Alarm Colour   | The Alarm Colour       |                    |

**Explanations:**

(1). Alarm Level: the alarm system can be set into 6 levels. Level 1 is the highest level. The alarm level for each port can be set according to the urgency of the alarm.

(2). Controllable or Not Controllable: if the port is set to be controllable, then the computer can control its ON/OFF directly.

(3). Sound Alarm Enable and Disable: the alarm message is prerecorded. The addresses of the alarm message are set by Sound On Address and Sound Off Address

B. Analog ports properties definition dialogue box

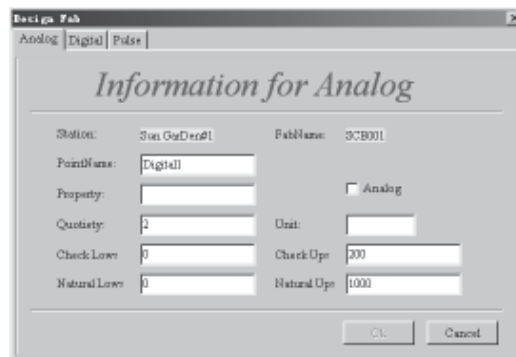

**Fig. 4-10.2 Tele-metering Point Properties Definition Dialogue box**

The content of each rail is as follows:

| Item        | Content                  | Remarks |
|-------------|--------------------------|---------|
| Point       | Defining the I/O Port    |         |
| Sum         | Accumulating the Input   |         |
| Simulation  | Setting as tele-metering |         |
| Property    | Property                 |         |
| Quotient    | Proportion coefficient   |         |
| Unit        | Unit                     |         |
| Check low   | The Lowest Limit         |         |
| Check up    | The Upper Limit          |         |
| Natural low | The Lower Limit          |         |
| Natural up  | The Upper Limit          |         |

Step 2. Click the **name of the station** to be controlled and the **name of the port** to be detected, the resources, signals and corresponding message of the FABs at the station will be displayed automatically. For example, in Interface 4-10, click Station Name **Sun Garden #1** and FAB Name **SGB001** the interface as in Fig. 4-11 will be displayed.

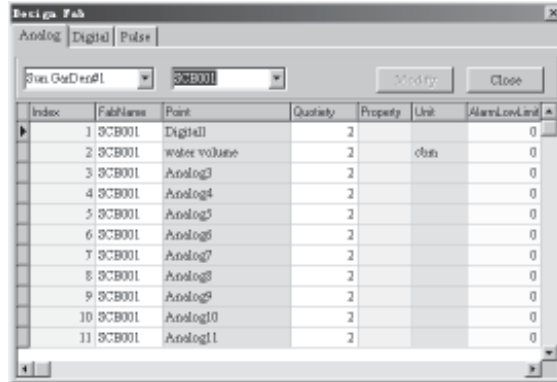

Fig. 4-11 Defining the FAB I/O Ports

In the table, the corresponding resources of the 20 I/O ports (12I/8O) of SGB001, 1~20 are displayed. Select the **item** to be modified and click **Modify**, the following dialogue frame in Fig. 4-12 will be displayed.

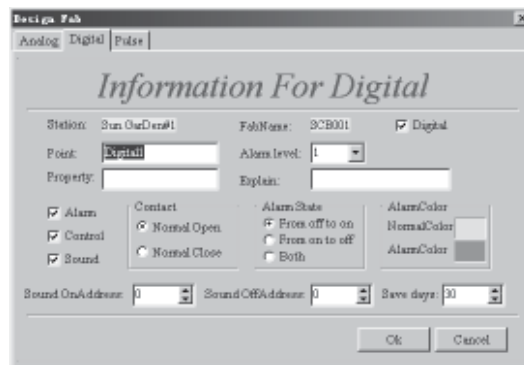

Fig. 4-12 Defining the Port II of FAB SGB001

In this example, Port II of FAB SGB001 is a tele-communicating port:

Point Name: Infrared Detector.

Alarm Level: 1 (The alarm levels of the system may be different from each other. And the highest level is 1.).

The point is an alarm port, and is non-controllable and provides for an audible alarm.

The contactor is normally open.

The alarm state is from OFF to ON.

Normal Colour is green, (It may be set by clicking the rectangle on the left of the Normal Colour.)

Alarm Colour is red.

Step 3. Define **Port I2 of FAB SGB001** using the same method, as the above, in Fig. 4-13.

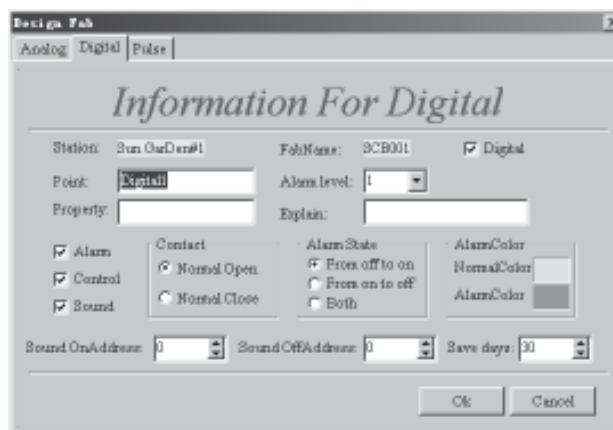

Fig. 4-13 Defining the Port I2 of FAB SGB001

Port I2 of FAB SGB001 is a tele-communicating port.

The Point Name is gas detector.

The alarm level is 1. (The alarm levels are set into 6 levels by the system and the highest level is 1.)

The point is an alarm port.

The port is controllable and provides for an audible alarm.

The contactor is normally open.

The alarm state is from OFF to ON.

The normal colour is green.

The alarm colour is red.

Step 4. Set Port I3 as the Light detector by the same method as above.

Step 5. Set **Port I4, Port I5 and Port I6** as **Water volume-Gas volume-Electricity value** respectively, as in Fig. 4-14.



Fig. 4-14 Defining the Tele-metering Port

Step 6. Define **Port I7~I12** as **spare ports**, not being used for the time being.

Step 7. Define **Port O1~O5** as **Fan Lamp Door lock, Cooking pot, Air conditioner**, respectively. They are all tele-communicating ports as in Fig. 4-15.

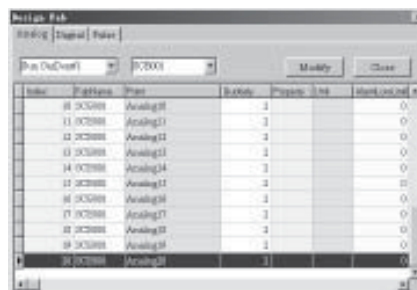



Fig. 4-15 Defining O1,O2,O3,O4,O5

Step 8. Define Port I8~2O(O6~O8) as spare ports. They are not used for the time being.

In the above, the definition of all of the input and output ports of FAB SGB001 are complete. Then define all of the input and output ports of FAB SGB002 by the same methods as above. The only difference is that the ports number of FAB SGB002 are 21~40. Using the same procedure as above, complete the definition of the input and output ports of all 100 FABs.

Note: The sound file name of the sound alarm is sound.wav. In the example, for the tele-communicating port 1, Sound On Address is 0 and Sound Off Address is 12. For tele-communicating port 2, the address of Sound On Address is 1 and the address of Sound Off Address is 13. By recording the different files, the voice prompting function can have different messages .

#### 4.4 Drawing Monitoring Interface

The FAB-Scada System provides some drawing editing function and allows the you to edit all kinds of monitoring diagrams according to the actual situation. To illustrate a complete system click the **Monitor Set-Drawing Tools** in the main function listing or click the **quick icon**  The following drawing interface, as in Fig. 4-16, will automatically be displayed in the system.

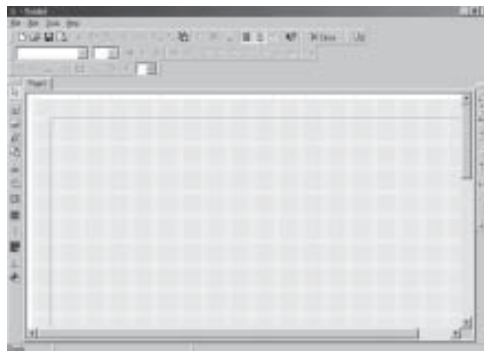

Fig. 4-16 Drawing Interface

##### 4.4.1 Operation Instruments In Drawing Interface

There are four main pull-down menus: File, Edit, Tools and Help.

File is mainly used for files management, such as New, Open, Save and Page Set as in Fig. 4-17.

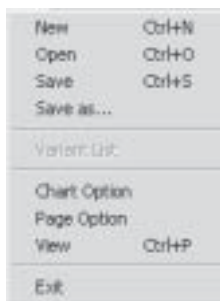

Fig. 4-17 File Menu

Edit is mainly used for the function of cutting, copying or deleting of the drawings as in Fig. 4-18.

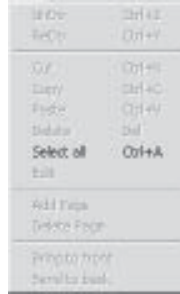

Fig. 4-18 Edit Menu

Tools has four options and the first two options have their own sub-function listing. And their main function is for the open and close of all other tool bars as in Fig. 4-19.

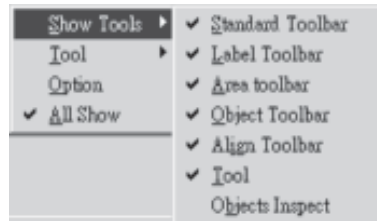

Fig. 4-19 Tools Menu

Help is used to open the help files as in Fig. 4-20.

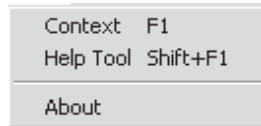

















Fig. 4-20 Help Menu

4.4.2 Drawing Tools













1. Basic tools: mainly used for the editing of the text.

|            |                        |                                  |
|------------|------------------------|----------------------------------|
| BasicTools |                        |                                  |
| New        | Set as the upper layer | Return to the pre-step operation |
| Open       | Add a Page             | Help                             |
| Save       | Delete a Page          | Set as the Bottom Layer          |
| Preview    | Select All             | Close the Drawing Interface      |
| Cut        | Page Set               | Cancel the Pre-step operation    |
| Copy       | Paste                  | Show the Grid                    |











2. Text property Tools: mainly used for the text edit in the procedure drawing.

| Text Property Tools          |   |   |
|--|---|---|
| Font Set                      | Size Set                             | Gothic Set                                   |
| Italic Set                    | Underline Set                        | Font Colour Set                              |
| Paragraph In the Middle       | Right-justify                        | Align In the Middle                          |
| Right-justify                 | Halve the Interval                   | Paragraph on the Top of the Page             |
| High Metering Properties Set  | Paragraph at the bottom of the Page  | Horizontal and Vertical Paragraph Switching  |









3. Main Drawing Tools: used for the building of the building frame, hot area definition and FAB definition

| Main Drawing Tools                                   |  |
|--|--|
| Define text and Tele-metering Point                  | Draw Horizontal and Vertical Line  |
| Insert Basic Frame (Rectangle, ellipse and so on.)  | Define Tele-Communicating Point   |
| Insert Spot-Diagram                                 | Define hot area                   |
| Define Pulsating Value                              | Define FAB                        |
| Define FAB    | Define FAB                        |
| Define FAB    |  |

4. Justifying Tools: Used for arranging the texts and the diagrams in the files in specified order.

| Justifying Tool Bar            |  |
|--|--|
| Left Justify                    | Right Justify               |
| Equal horizontal spacing        | Halve intervals vertically  |
| Align in the middle vertically  | Align in the centre         |
| Bottom Justify                  | Top Justify                 |
| Equal vertical spacing          | Align Group in the Centre   |

5. Grids Setting Tools: Used for the frame lines and the colours of the diagrams setting.

| Internet Setting Tools                       |   |
|--|---|
| Top line rim                                 |    |
| Right line rim                               |    |
| Whole line rim                               |    |
| Set drawing pen colour                       |    |
| Set the colour degree of the form background |    |
| Bottom line rim                              |  |
| Left line rim                                |  |
| Cancel line rim                              |  |
| Set drawing pen width                        |  |

#### 4.4.3 Drawing the Monitoring Diagram

##### 4.4.3.1 Page Setting

This function is mainly used for the page size and background colour setting, etc. Select File-**Page Option** or double click the **page zone**. The page setting Dialogue box will be displayed, as in Fig. 4-20.

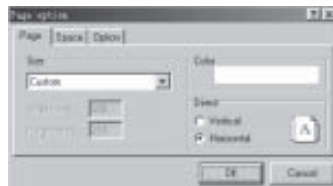

Fig. 4-20 Page-setting Dialogue box

Select the Page Number: In the tabulate, select or self-define the size of the page. Double click the **rectangle zone in the Colour** to set the background colour of the page as in Fig. 4-21. And the page can be set in long or cross direction.

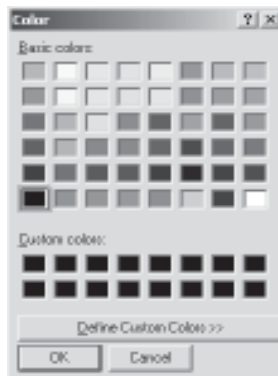

Fig. 4-21 Colour Set

Select the Space Page to set the blank space at the margin. If you select **Enable** then the blank space will be effective and at the same time the size of the blank space zone can be modified, as in Fig. 4-22.



Fig. 4-22 Set the Size of the Blank Space

#### 4.4.3.2 Draw the Monitor Diagram

In this system basic drawing tools are provided, such as inserting basic objects, pictures, inserting BMP picture files, inserting animated pictures, invoking the information and resources of the FABs, drawing the basic picture frame and inserting the special objects pictures.

**Step 1:** Insert basic objects  and BMP pictures:

Previously we mentioned that we provide some component pictures frequently used in the automation control system, such as a valve, water pump, electric motor and so on, for the users to invoke directly. These can be invoked from user-made BMP picture files. The detailed operations are as follows.

1. Click the button and move the mouse to the **drawing interface**, the dialogue block as in Fig. 4-28 will be displayed.



Fig. 4-23 Set the Background Diagram of the Page

2. According to your needs, click the required **component picture** in the following pictures. For example: click **Valve**, then valves of all shapes will appear.



Fig. 4-24 Set the Background Picture of the Page

Similarly, you may select the other diagrams, here we will omit the detailed procedure. When you select the **Image** option, as in Fig. 4-30, you may insert the **BMP picture files**.



**Fig. 4-25 Inserting BMP Picture Files**

Select **Load** in the above figure, the system will prompt the files-opening dialogue frame as in Fig. 4-26. Select and open the home2.bmp and click **OK** thus the home2.bmp will be added to the diagram editing. You can move the inserted pictures and zoom them in and out.



**Fig. 4-26 Files Opening Dialogue Frame**

After inserting a selected picture, you may obtain the ideal visual effects by zooming in/out and moving the position. Simultaneously, the adjusting tools previously noted, can adjust the picture position as required. The picture can then be set to different colours.

**Step 2. Insert Basic Shape Form**

1. Click the **quick icon**  then move the mouse to the **drawing interface**. The following dialogue frame, as in Fig. 4-27, will be shown.



**Fig. 4-27 Insert Some Basic Shape Form**

2. Click any **basic shape form** you need, then the shape form can be easily inserted into your drawing interface. The system provides for 8 types of basic shape forms, including: the block flow diagram, the circumference diagram, the block flow with round corners and the cylinder diagram, etc.

**Step 3. Insert Animated Pictures**

This function is mainly used to dynamically show the state of the input and output of equipment. For example, the exhaust fan is working, and so on. You may need to formulate some animated pictures of the exhaust fan running and save the pictures in the form of an animated picture. For example, to save the animated pictures file as fan.gif.

1. Click the **quick icon**  and move the mouse to the **drawing interface**, then the dialogue frame, as in Fig. 4-28, will be shown in the system as below.

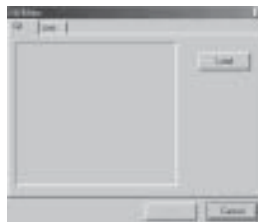

**Fig. 4-28 Insert Animated Picture 1**

2. Select and click **Load**, the system will prompt the path to save the file fan.gif ,Click the **file name** and **confirm**, then the files will be inserted.

3. Select and click **Link**, the system will display the dialogue frame as in Fig. 4-30. Select the FAB I/O Port of the working station that actually corresponds to the exhaust fan and then click **Confirm**. The animated picture insertion and interconnecting is then complete. When the exhaust fan is running normally, the required operating conditions being satisfied, its state will be transferred in real-time to the monitoring system. It will be shown in the designed animated pictures. With this function you may observe the running state of any equipment graphically.

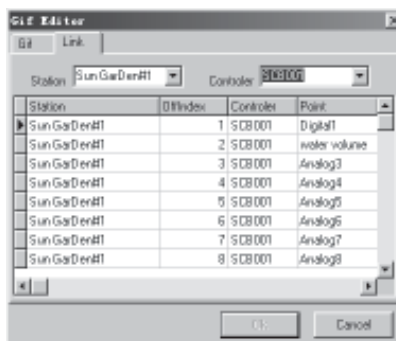
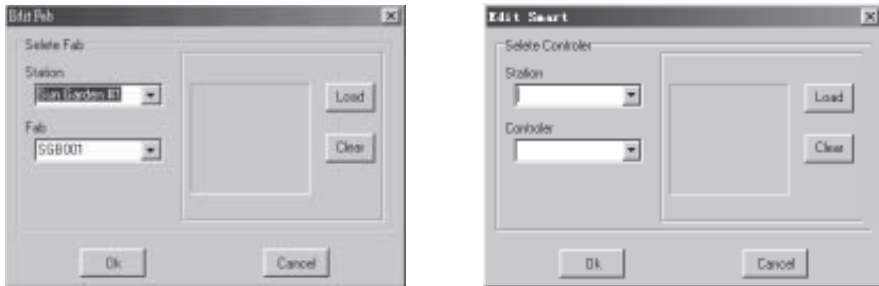

**Fig. 4-30 Connect the Input and Output of Animated Picture and FAB**

**Step 4. Insert FABs**

The system provides the function which enables the FAB to be inserted directly, with the resources of the input and output ports, and directly show in the running diagram. If an input/output port is a switch value, the ON/OFF state can be seen in the monitoring interface. If an input/output port is an analog or a pulse value, the value of the analogue or pulse can be shown in real-time in the monitoring interface. Before running the function you need to save the pictures of the FAB under the path .\SCADA.

1. Select and click the icon  and move the mouse to the drawing interface, the dialogue frame as in Fig. 4-31 will be shown in the system. Then select the corresponding FAB.



**Fig. 4-31 Insert FABs**

2. Write down the picture of the corresponding FAB, as in Fig. 4-32, and the click **Confirm**. Thus the insertion of the FAB is complete.

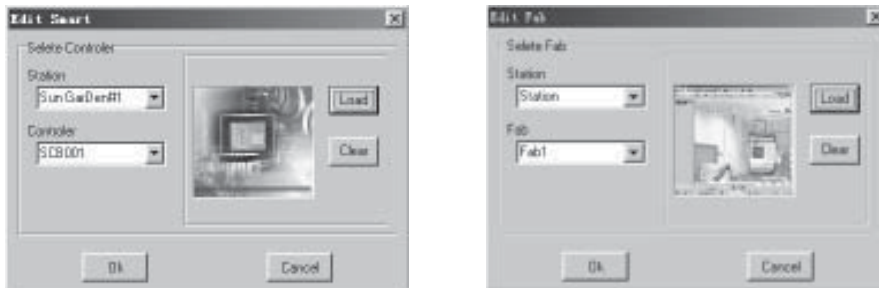

**Fig. 4-32 Interface of Inserting FABs**

**Step 5. Insert OLE Objects**

The system provides for a direct access function for all the of the pictures of measuring instruments. This function is mainly used for the access of the tele-metering signals.



1. Select and click  and then move the mouse to the drawing interface, then the dialogue frame, as in Fig. 4-33, will be shown in the system.
2. Select the corresponding icon button of the required object and connect to the corresponding tele-metering signal port. The port: such as manometer, thermometer, level gauge and so on, will then be monitored in real-time



Fig. 4-33 Insert OLE Objects

**Step 6. Insert Chart Pictures**

This function is mainly used for the direct access of tele-metering signals and provides for the block flow diagram, the circumference diagram, the block flow with round corners, the cylinder diagram and so on. This feature makes the monitoring of the tele-metering signals more straight forward and clear.

1. Select and click the **quick icon**  and then move the mouse to the **drawing interface**, and the dialogue frame, as in Fig. 4-34, will be shown in the system.

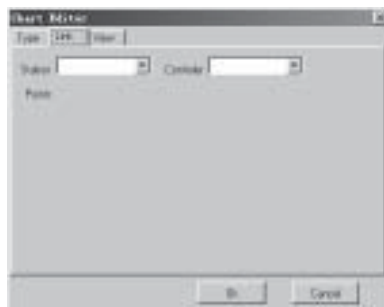

Fig. 4-34 Insert Chart Diagram and Form

2. Select the **Input port of the FAB** to be defined. Click **Type** and select the required shape form, as in Fig. 4-35.

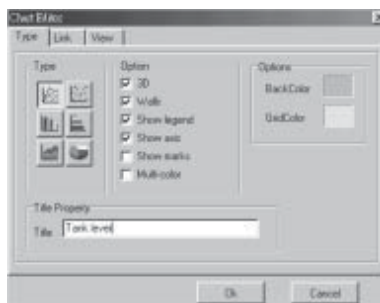

Fig. 4-35 Select the Diagram

3. Click **Confirm** to confirm and the setup is completed. During the normal execution of the system, the diagram will be shown as the analog value received from the site.

**Step 7. Define Hot Area**

As for any complex monitoring system, you cannot monitor by the use of one diagram. You will need many diagrams for monitoring. You will need to build lines between the pictures to realise the related switching between the graphics.



**Fig. 4-36 Define the Hot Area**

As in Fig. 4-36, the main monitoring diagram, there are Brief Introduction of ARRAY-System Arrangement Diagram and so on. Click **Supervisor of the Office**, and then the corresponding household monitoring diagram, as in Fig. 4-37, will be shown in the system. This link is called the Hot Area.



**Fig. 4-37 Family Monitoring Diagram**

The methods of hot area definition is as follows:

1. Click the **quick icon** of the hot area  move the mouse to the **position in which to put the hot area**, then move it together with the rectangle appearing and click the **position where the rectangle appears**, then the dialogue frame, as in Fig. 4-38, will be shown. If you want to modify the defined hot area, just double click **the hot area** in the drawing diagram and the hot area definition dialogue frame, as in Fig. 4-38, will be opened.

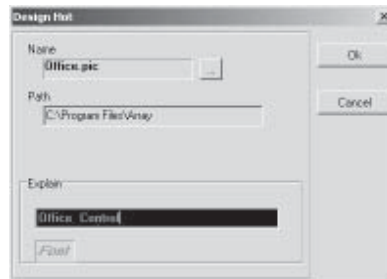

**Fig. 4-38 Define Hot Area**

(1) Name: Select the **Name files** and click the **rectangle zone** on the right of Picture, and the file open dialogue block, as in Fig. 4-39, will be seen. Select the **directory path** (the same directory as the FAB-Scada). If the Office.pic file exists, select the **picture file** and then the diagram corresponding to the Hot Area household Monitor is set as the picture Office.pic

(2) Explain: the explanation of the picture files. Input a paragraph of **abstract explanation** in the editing diagram on the left of Explain, and the words will be displayed in the picture diagram. If there is no input, the diagram will display the background contents in the transparent manner, thus to realise the hot area definition of the background. For example, all the hot areas on the main diagram are produced on the same background diagram.

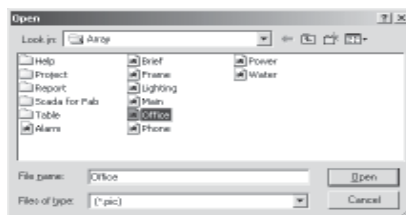

Fig. 4-39 Select the Picture Files

(3) Font: Set the font of the explanation word. Double click the left zone of **Font**, the font setting dialogue frame, as in Fig. 4-40 will be seen. The shape, size, colour and so on can be set in the dialogue block.

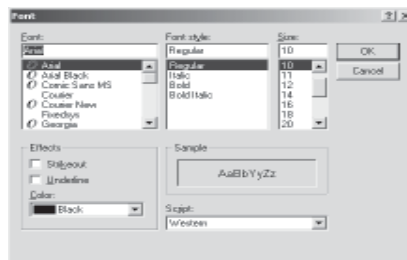

Fig. 4-40 Set Font Properties

2. Set Hot Area background. Click the **quick icon**  of the background setup, the dialogue block, as in Fig. 4-41 of colour will be seen. The background colour can then be set in the diagram.

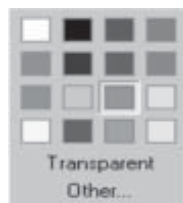



Fig. 4-41 Set the Background of the Hot Area

**Step 8.** Setup the Input and Output ports.

After editing a monitoring diagram, all of the input and output ports of the FAB in the diagram need to be shown so as to achieve the monitoring of the ports. As for different signal ports, such as tele-communicating, tele-metering and tele-pulsating, you will have different setup methods and the details are as follows:

1. Setup the Tele-communicating Point

Select and click the **quick icon**,  then a small green check (meaning the monitoring point) will appear in the diagram and at the same time the system will prompt the dialogue frame, as in Fig. 4-42. In the Link page click the **station-listing frame** and select the station named **Sun Garden#1**, at the same time list all of the FABs of the station in the controller-listing frame. Then select the first **FABSGB001** and select the **Infrared detector** (when the FAB is defined). All of the I/O ports of the FABs will be shown in a list. Thus the definition of a tele-communicating point is done. During the normal operation of the system, the state of the II of the SGB001 will be shown by the green check.

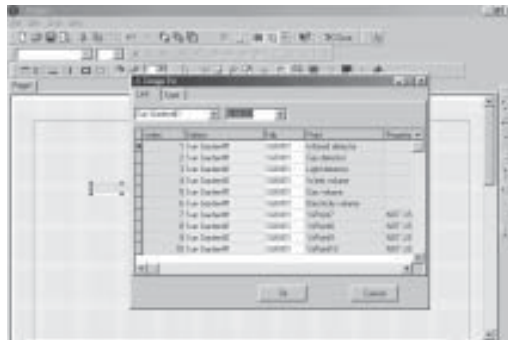

**Fig. 4-42 Tele-communicating Port Setup Dialogue Frame**

2. Setup the Tele-metering Point and theText Frame

Select and click the **quick icon**  and move the mouse to the **corresponding position**. The following dialogue, in Fig. 4-43, will appear.

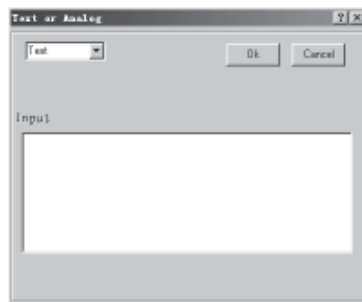

**Fig. 4-43 Tele-communicating Point and Text Frame Setting up Dialogue Frame 1**

There are two options: Text and Remote measurement (digital input) in the pull-down menu at the upper-left corner in the diagram. Select **Text**, and the text can then be placed. Enter the text in the Input zone and then click **OK**. The text is then placed. The text is used for the title and for explanatory notes and can be used for tele-communicating and tele-metering points.

Select **Remote measurement**, and the tele-metering point can be placed. Select and click the **Link page** and then the dialogue frame for placing tele-metering point, as in Fig. 4-44, will be displayed. The two pull-down menus are used for selecting the station name and the FAB name.

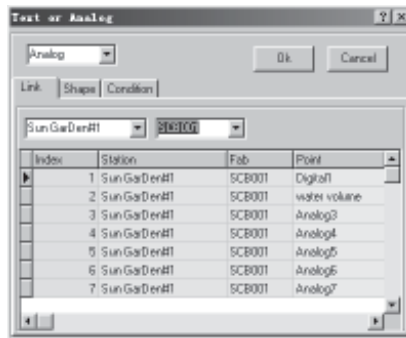

Fig. 4-44 Tele-metering Point Setup Dialogue Frame

Select **Sun Garden #1** in the station-listing table and select **SGB001** in the list of FAB's. Thus the listing menu will show all of the information of the tele-metering SGB001. Select **Remote measurement point 3** in the listing table and click the **OK** button. Thus the placement of the tele-metering point Remote measurement point 3 and the connection of the relative resources are completed. The details are as in Fig. 4-45.

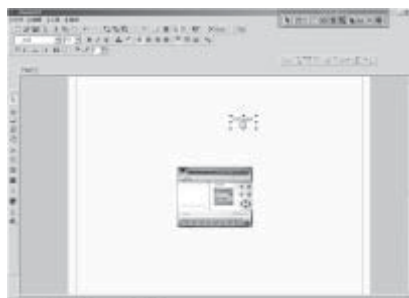

Fig. 4-45 Complete the Setup of Tele-metering Point Placement

Select and click **Shape** in Fig. 4-46, and you can select the shape form of the tele-metering point unit as in Fig. 4-46.

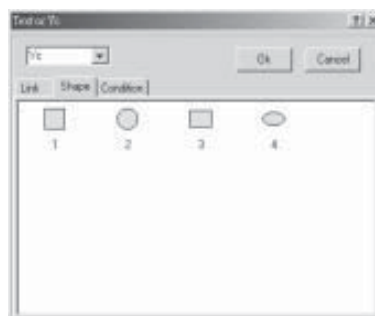

Fig. 4-46 Select the Shape Form of the Tele-metering Point

#### 4.4.3.3 Analyse the Communicating State

Click the menu **Monitor/Communication** as in Fig. 4-47.

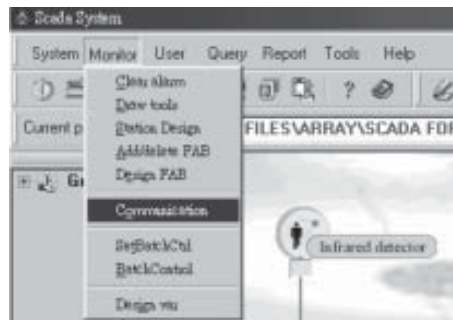

Fig. 4-47 Monitor/Communication

The FAB-Scada System provides the function of showing the binary codes of the FAB as in Fig. 4-48.



Fig. 4-48 Analysing Diagram of the Communicating State

**Function:**

- (1). The dialogue block records the communicating time, the number of the accepting character, the length of the frame, the time of the errors and calculates the rate of error codes.
- (2). If you need to observe carefully the current information, just click **Stop** to pause.
- (3). The current resources in the files which may need to be analysed and/or used can be saved.
- (4). The original resources of the current frame can be printed.

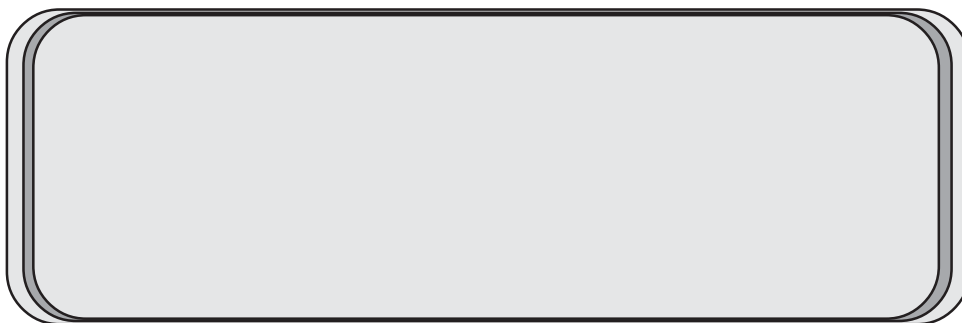

## Chapter 5 User Management

When considering the security of the system, it is necessary for you to manage all of the customers in the whole system. Only the users with the appropriate authorities can enter the system to observe or modify it. User Management mainly includes Modify Manager Name, Append, Delete and User Login function items as in Fig. 5.1.

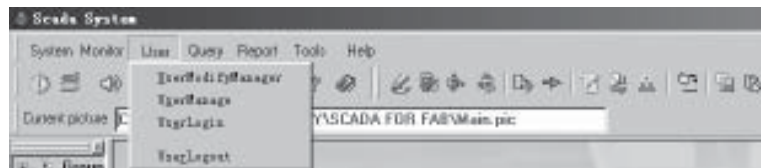

Fig. 5-1 User Management

### 5.1 Modify Manager Name

Select **User>User Modify Manager** function item, as in Fig. 5-2 or click the **quick icon**

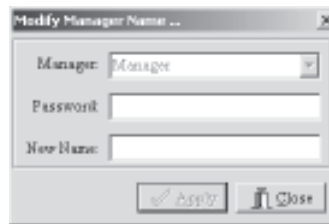

Fig. 5-2 Modify Manager Name

In Fig. 5-2, select **Manager** and enter the **password 0001** then enter the **new manager name** and click **OK**. The function of modifying the manager name is done. (The default manager name is Manager and the default password is 0001)

### 5.2 User Management

This function item is only for the use of the manager. It mainly includes Append, Delete and Modify Password (including the manager's password). The details are as follows in Fig. 5-3.



Fig. 5-3 User Management

### 5.2.1 Append

Select and click **Append** as in Fig. 5-4. In the interface enter **the user name, password**, and then confirm the password. If the user's name exists, the system will prompt for it to be re-entered. The password and its confirmation must be the same. Finally click the **OK** button.

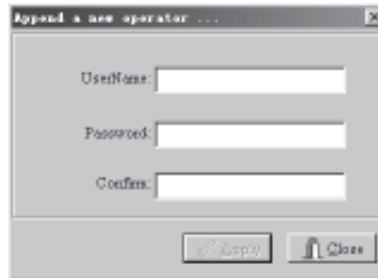

Fig. 5-4 Append

### 5.2.2 Delete

In Fig. 5-5, select the **user's name** to be deleted in the listing table and click **Delete**, then the prompting dialogue block as in Fig. 5-6 will be displayed to prompt you whether you really want to delete the user.

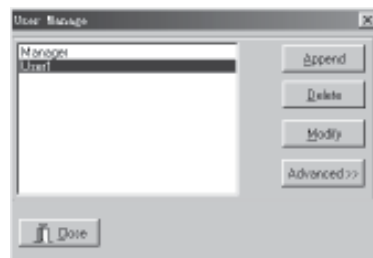

Fig. 5-5 Delete



Fig. 5-6 Confirming Dialogue Frame

### 5.2.3 Modify the Password

Click the **user's name** (including the manager) to be modified and then click **Modify**, as in Fig.5-7. Enter the **old password** and the **new password**, and then confirm the **new password**. The new password is to be **entered twice**. Finally click the **OK** button and the password is changed.

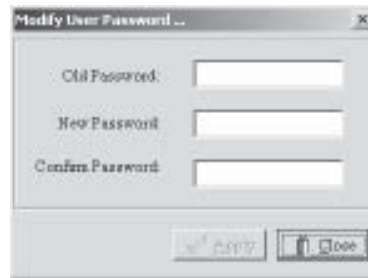

Fig. 5-7 Dialogue Frame for Modifying Password

### 5.2.4 Query the User Information

Select and click **Advance**, the dialogue block as in Fig. 5-8 will be displayed and the information of all the users will be shown in the listing table. Clicking **Advance** again will cancel the listing table shown.

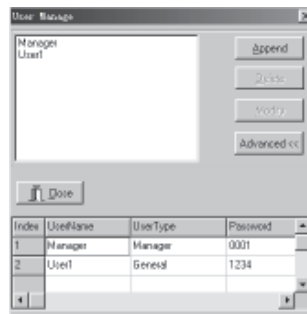

Fig. 5-8 Querying the Users' Information Dialogue Frame

### 5.3 User Login

When entering the system, the user is authorised, within the scope of the authority, to carry out general operations. The user must login ,as in Fig. 5-9, for more advanced operations. Login can only be tried for three consecutive times. If the user fails to login after third time, the system will exit automatically. If the user does not carry out any operation after login the system will automatically cancel the authorities of the current user and authorise the user as general operator again. If the user must log in if there is a need to carry other operations.

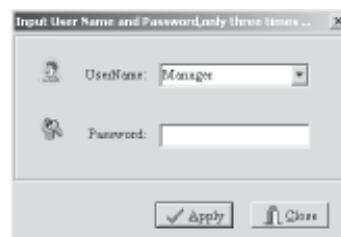

Fig. 5-9 User Login Dialogue Frame

*Note: After entering the password the Enter key or the OK button must be clicked!*

#### 5.4 User Logout

The user will need to logout when the user is out of the office. Other users will need to login as required. This feature provides the security for the system.

#### 5.5 Explanations for User Authorities

Manager: (one only): Having access to all of the functions.

General User: (may be several): Not having access to the following functions.

[Deploy] [Clear Alarm] [Draw Tools] [Station Design]  
[Add/Delete FAB] [Design FAB ] [BatchControl]  
[UserModifyManager] [UserManage] [Backup DB] [Create Report]

User with Lowest Authority: (Non User): Not having access to the following functions.

[Deploy] [Clear Alarm] [Draw Tools] [Station Design]  
[Add/Delete FAB] [Design FAB ] [BatchControl]  
[UserModifyManager] [UserManage] [Backup DB] [Create Report]  
[Set FABTime]

Explanation: When all of the users logout of the system , the system will automatically be set to the state of lowest authority.



## Chapter 6 System Configuration

The System Configuration includes the following function such as Set FABTime, Print, Deploy and Exit. Click the main menu **System** and select the operation item from the pull-down menu, or click the **quick icons**, as illustrated, to carry out the desired operations.

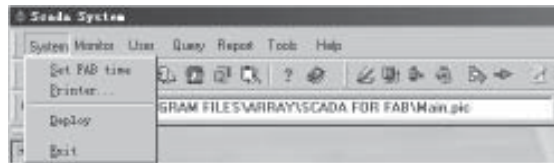

Fig. 6-1 System Configuration Instruments Selecting Menu

### 6.1 Set FAB Time

At the time when the system has been completed, or after a period time when the system has been running, it is necessary to set the time for each FAB using the upper computer as the reference time. This step is necessary to guarantee the agreement of the times between each FAB and the upper computer. The detailed procedure to accomplish this is as follows:

1. Select and click the option **System>Set all FAB Time** then a dialogue frame to carry out the operation of setting the time will be displayed in the interface, as in Fig. 6-2.



Fig. 6-2 Dialogue Frame for Setting FAB Time

2. Select **Yes** to realise the function of time setup.

This function is used for synchronizing the time of all FABs to the time of upper computer so that the upper computer can effectively manage all of the FABs simultaneously.

### 6.2 Print

1. Select and click the options **System Print**, then a dialogue block required to carry out the print setup operation will be displayed in the interface as in Fig. 6-3.

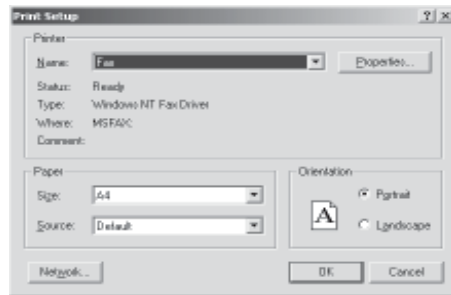
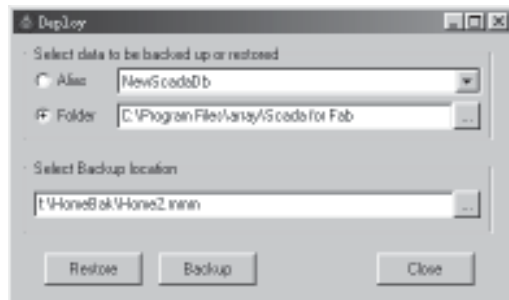

**Fig. 6-3 Print Setting Dialogue Block**

**6.3 Deploy**

After editing a monitoring system, you will be able to package all of the diagrams and relative configuration files into a project files. For example, the household-monitoring system can be packaged into a text file named Home2.mmm and it can then be deployed to other computers. Other computers may unpack the text file and rerun all of the diagrams and configuration files. The detailed operations are as follows:

Select and click **Deploy** or the **quick icon**,  then the following dialogue block, as in Fig. 6-4, will be displayed in the interface.



**Fig. 6-4 Dialogue Block for Back-upping and rerunning**

**1. Backup**



(1) Select the database: In Select data to be backed up or restored to select **Alias** is to package the data base and to select the **quick icon**  on the left of Folder is to select the current path of FAB Scada. For example, c:\Program Files\ARRAY\SCADA for FAB is to say that FAB Scada is under the directory of c:\Program Files\ARRAY\SCADA for FAB.

(2) Set the **saving directory** and **file name** for the packaging files. For example: Set the path as f:\HomeBak and set the file name as Home2.mmm.

(3) Select and click **Backup**, the system will package and zip files.

With the above procedures, FAB-Scada will package all of the files under the directory of c:\Program Files\ARRAY\SCADA for FAB into the file f:\HomeBak\Home2.mmm.

## 2. Rerun

- (1) Select the **path** to be rerun or click the **quick icon**  of **Folder** and set the path as: D:\Scada
- (2) Select the **file** to be packaged or click **quick icon**  Select **Backup location** and find the file F:\HomeBak\Home2.mmm.
- (3) Select and click **Restore**, and the system will enter the state of disconnecting the package.

3. After the completion of disconnecting the package, the system will prompt to restart the FAB-Scada system.

By the use of above procedures, FAB Scada reruns the packaged files Home2.mmm under the directory F:\HomeBak to the directory D:\Scada

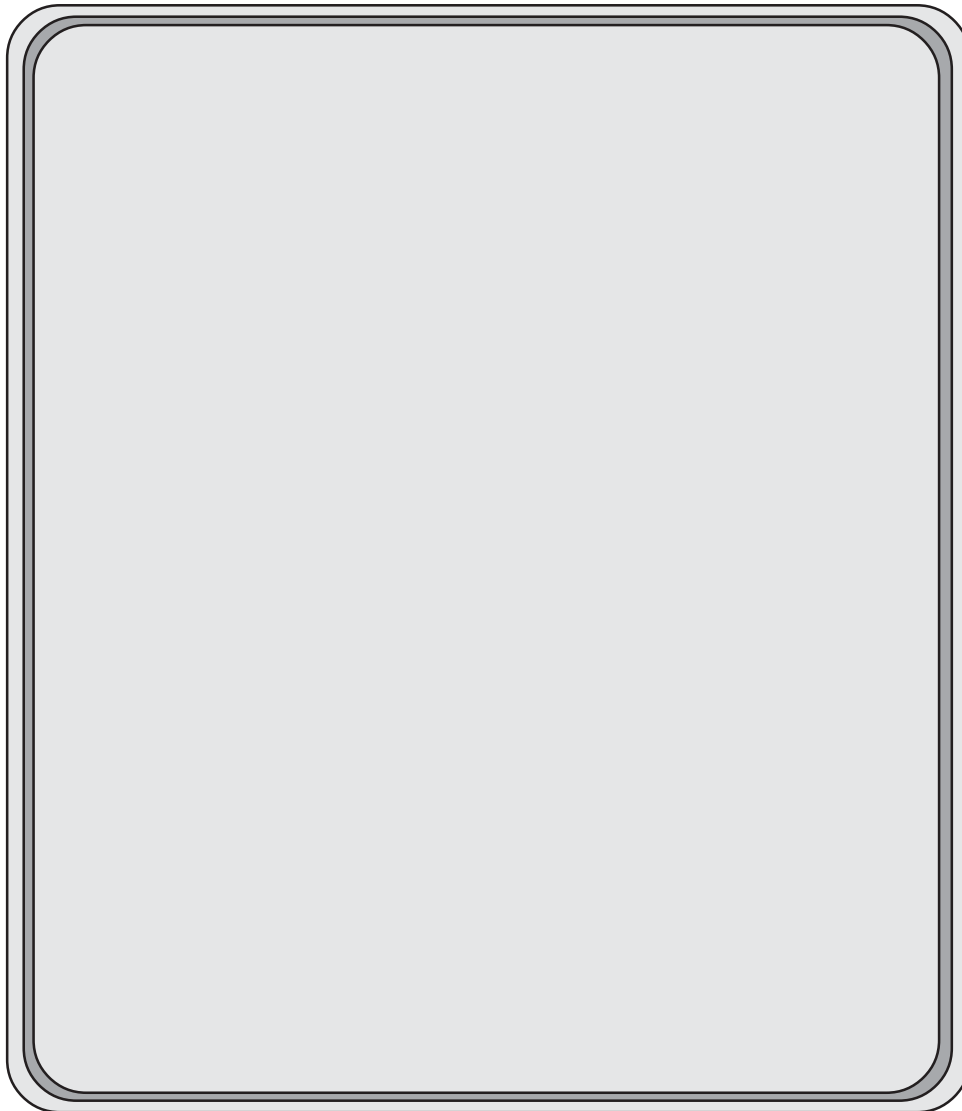

## Chapter 7 Data Query

Many different type of data are produced in the process of the system operation. The FAB-Scada software provides the function of data querying and backup..

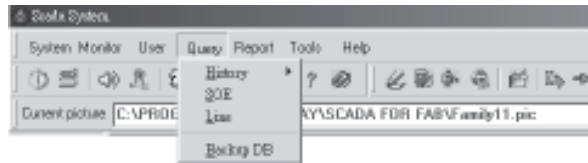

Fig. 7-1 Data Query

### 7.1 Data Query

#### 1. The Tele-metering History Data Query:

Select and click **Query>History>Remote measurement**, the dialogue block as in Fig. 7-2 will be displayed. Select **Sun Garden #1** in the station-listing table and select **FAB 2** in the FAB listing table, then select the date. The system will list all of the related data and show the history changes of the tele-metering point in the form of a line diagram.

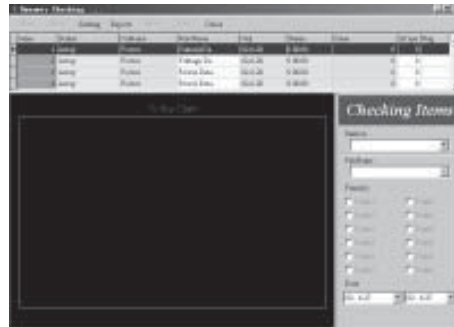



Fig. 7-2 History Data of Tele-metering Point

2. The Tele-communicating Data Query

(1) Data Query: As in Fig. 7-3, select the conditions to be queried in the figure and then click the **quick icon**. 

The relationship between the conditions is AND. Thus the relative data will be shown in the interface.



Fig. 7-3 Tele-communicating Data Query

(2) Alarm Off: Double click the **top of the record** to cancel the alarm. Then click **Yes** in the dialogue block shown at the same time, as in Fig. 7-4.



Fig. 7-4 Alarm Off

(3) Delete the Records of Alarm Off or Over the Save Days: Click **Delete**, and the dialogue block, as in Fig. 7-5, will be displayed on the interface.



Fig. 7-5 Records Deleting Dialogue Block

Select the **record type** to be deleted in the dialogue block Alarm Off /Over the Save Days, then select the **user** as manager and enter the **password**. Click the button **OK** will change FAB-Scada into the operation state. Click **OK** and the system will display the confirmation dialogue block. Select **Yes** to delete the record. It will take a while if a large amount of data is to be deleted.

(4) Design the Report: Select and click **Design** and you will then enter the diagram of the designing report ,as in Fig. 7-6. You can then design various reports according to your requirements.

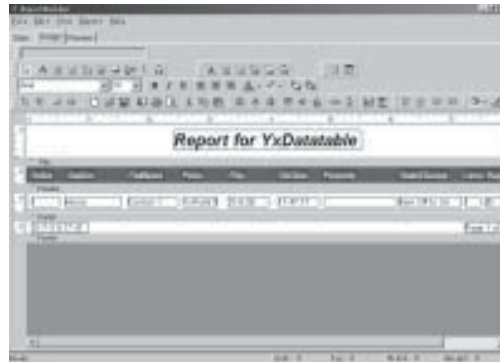



Fig. 7-6 Design the Report

5. Print the Report: Select and click **Print**.

### 7.2 Backup the Data Base

After a period of running the FAB-Scada System it needs to be backed up to maintain the database and in order for the FAB-Scada System to run effectively. Click **Query>Backup** or the **quick icon**,  then the dialogue block, as in Fig. 7-7, will be displayed.

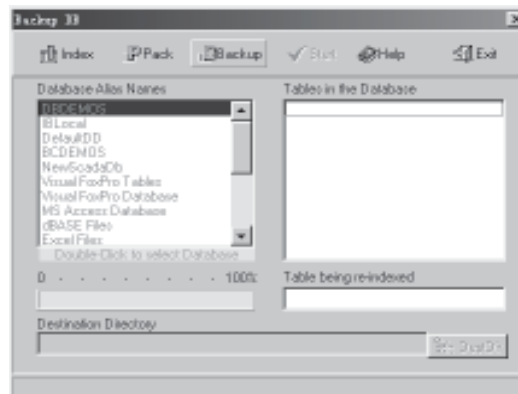

Fig. 7-7 Backup Dialogue Block

(1) Index the Database: Click **Index** and the listing table frame under the Database Alias Names will change from gray to black. The database name of the FAB-Scada System is NewScadaDB. Double click the option **NewScadaDb**, and the listing table of Table in the Database will show all of the table menus of NewScadaDB

(2) Pack the Database: After selecting the database, it is necessary to package the database. Click **Pack**. The system will then enter the packing state.

(3) Backup the Database: After packing the database, click the **Backup**, the system will then enter the backup state.

(4) Select the Saving Directory of the Database. Select and click the **DestDir** to do the selection.

After the completion of the above procedures, click **Start**, and the system will carry out the backup of the database. After the backup, click **Exit** to exit the database backup dialogue frame.

2.3 Modify the properties of the listing option. First select the **listing option** to be modified and then click the **right mouse button**. Then the dialogue block, as in Fig. 8-23, will be shown. Select the **Property function** option, then the **dialogue block**, as in Fig. 8-26, will be shown. In the dialogue block, modify the Description and FilePath, and then click **Apply**. Thus the modification is completed.



## Chapter 8 Report

The Report function options include Create Report and Browse Report as in Fig. 8-1.



Fig. 8-1 Report

### 8.1 Create a Report

Select the function option **Report>Create Report** or click the **quick icon**,  the designing interface, as in Fig. 8-2 will then be displayed.

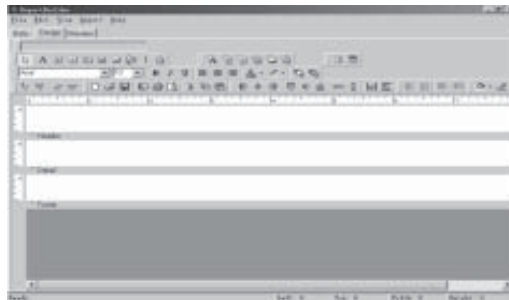

Fig. 8-2 Report Creating Interface

The main procedures are as follows:

1. Select Database Original: Click the page key **Data** and then select **File>Data Settings**. Then carry out the selection as in Fig. 8-3.

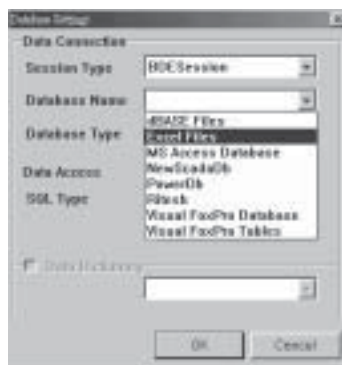
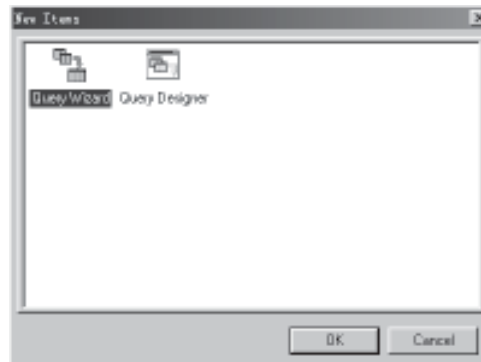

Fig. 8-3 Select the Database Original

2. Select the Table Menus

2.1 Select File-New and then click **Query Wizard**.



**Fig. 8-4 Select the Listing Table 1**

2.2 Double click the table name in Fig. 8-5. For example, select **Remote signal datatable**, and it will appear in the listing table frame on the right. Then click the button **Next**.

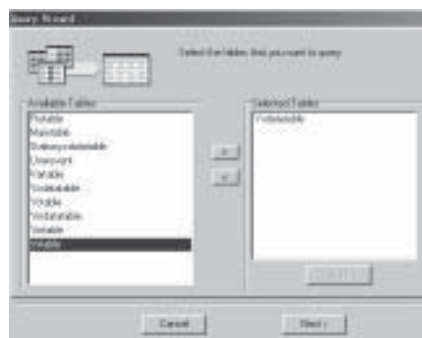

**Fig. 8-5 Select the Listing Table 2**

2.3 Choose the fields, as in Fig. 8-6. All Fields means choosing all of the fields and Choose Fields means choosing the required fields. Then click **Next**.



**Fig. 8-6 Select the Fields**

2.4 Select the Calculating Fields, as in Fig. 8-6: No Calculations means no calculating fields and Add Calculations means adding the calculating fields. Then click **Next**.



**Fig. 8-7 Select the Calculating Fields**

2.5 Select the Grouping Fields as in Fig. 8-7. No Grouping means no grouping fields and Select Grouping Field means adding grouping fields. And then click **Next**.



**Fig. 8-8 Select the Grouping Fields**

2.6 Select the **query condition** as in Fig. 8-9. All Row means selecting all of the records and Define Search Criteria means selecting the records to be queried. Then click **Next**.

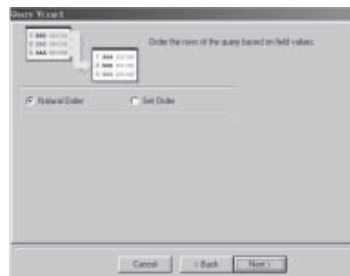

**Fig. 8-9 Select the Query Conditions**

2.7 Select the ordering conditions as in Fig. 8-10. Natural Order means not ordering and Set Order means selecting the ordering fields. Then click **Next**.

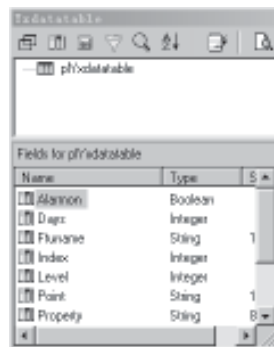

**Fig. 8-10 Set Ordering Fields**

2.8 Click **Finish**, as in Fig. 8-11. Then the listing table of the database that has been set will be displayed, as in Fig. 8-12.



**Fig. 8-11 Last Step of Selecting the Listing Tables**



**Fig. 8-12 The Completion of Selecting Listing Tables**

3. Select the page key **Design** and enter the report design window:

3.1 Title: For example, as in Fig. 8-13, set the title of the report as Report for Remote signal DataTable.



**Fig. 8-13 Design the Title of the Report**

3.2 Design the Head of the Report. For example, as in Fig. 8-14, set the **labels** such as Index, Station, FAB Name and so on.

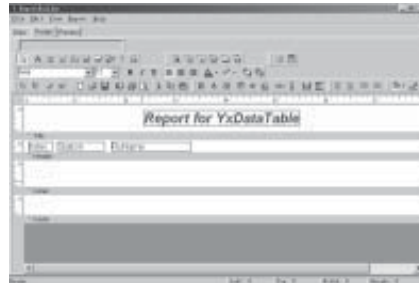

**Fig. 8-14 Design the Head of the Report**

3.3 Design the Body of the Report. For example, as in Fig. 8-15, set the **fields** such as Index, Station, FAB Name and so on.

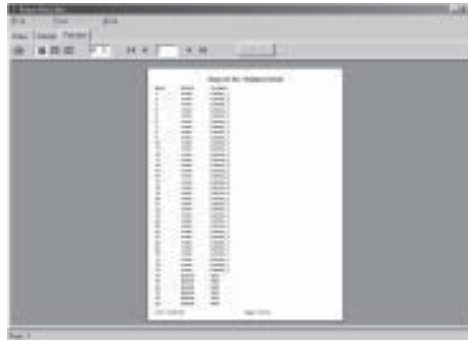

**Fig. 8-15 Design the Body of the Report**

3.4 Design the Report description: For example, as in Fig. 8-16, set the **system variable** as DateTime, PageSetDesc.

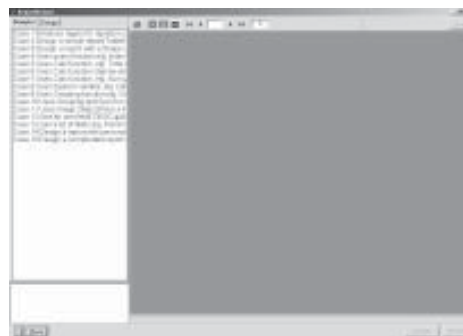

**Fig. 8-16 Design the Date and the Page Code**

4. Preview the Report: Select and click the page key **Preview** as in Fig. 8-16. And the diagram as in Fig. 8-17 will be displayed.

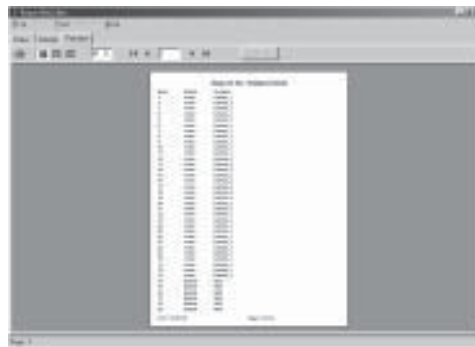
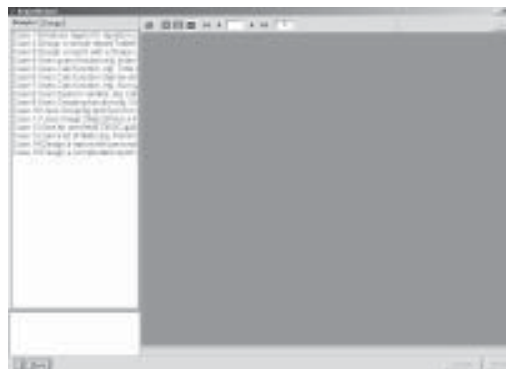

**Fig. 8-17 Preview the Report**

**Explanation:** Refer to Report Builder Users Manual for detailed help information.

**8.2 Browse**

Select **Report>Browse** or click the **quick icon** ,  then the diagram, as in Fig. 8-18, will be displayed.

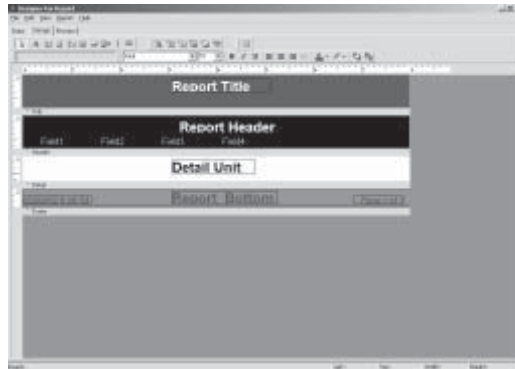

**Fig. 8-18 Reports-Browsing Interface**

1. The example of browsing the report. Select the page key **Examples**. Click the **listing option** in the listing table, the browsing results will be shown in the sub-interface as in Fig. 8-19. Double click the **listing option**, the designing interface will be shown, as in Fig. 8-20. The example cannot be changed.

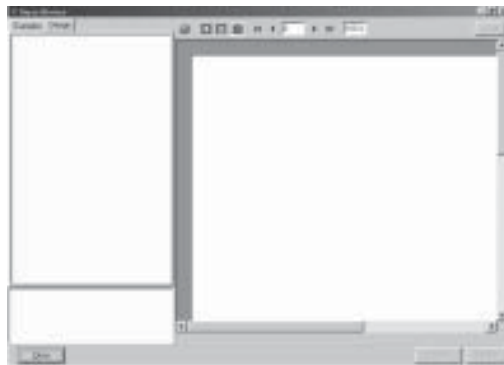

**Fig. 8-19 Click the Listing Option Once**



**Fig. 8-20 Click the Listing Option Twice**

2. Design the Report: Select the page key **Design** and the listing table is empty, if opened for the first time, as in Fig. 8-21.

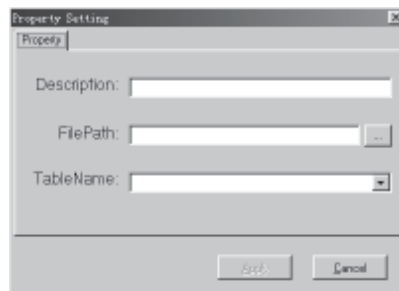

**Fig. 8-21 Select the Page Key-Design**

2.1 Add the Designed Report to the Table List. Click the right key of the mouse in the listing table, and the dialogue block as in Fig. 8-22 will be shown. Select the function option **Append** and the dialogue block, as in Fig. 8-23 will be shown.



**Fig. 8-22 Click the Right Key of the Mouse**



**Fig. 8-23 Select the Function Option-Append**

Referring to Fig. 8-21, enter the **name** describing the use of the report in the position of Description and the path and name of the report in the position of FilePath or click the **quick icon**  to open the dialogue block for selecting the files to be opened.

Then click **Apply**, as in Fig. 8-24. A new record is added to the listing table frame as in Fig. 8-25.

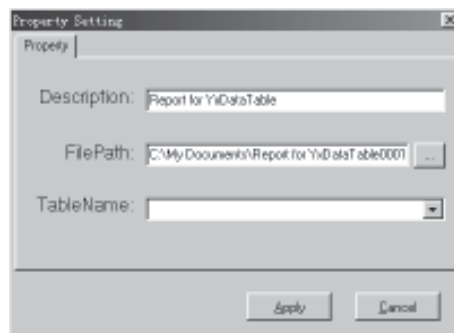

**Fig. 8-24 Entering the Options**

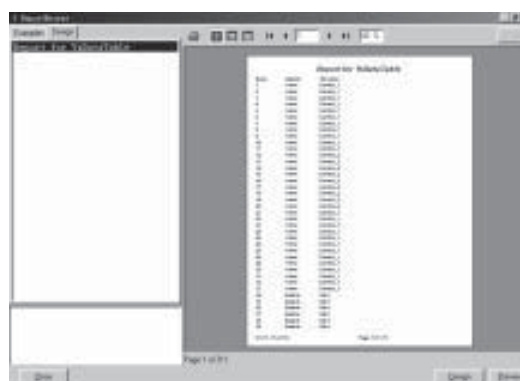

**Fig. 8-25 The Page After Clicking 'Apply'**

At this time, you can preview the report by clicking the mouse **once** and design the report by clicking the mouse **twice**.

2.2 Delete the listing option from the listing table. First select the **listing option** to be deleted and then click the **right mouse button**. Then the dialogue block, as in Fig. 8-22 , will be shown. Select the **Delete** function option.

2.3 Modify the properties of the listing option. First select the **listing option** to be modified and then click the **right mouse button**. Then the dialogue block, as in Fig. 8-23, will be shown. Select the **Property function** option, then the **dialogue block**, as in Fig. 8-26, will be shown. In the dialogue block, modify the Description and FilePath, and then click **Apply**. Thus the modification is completed.

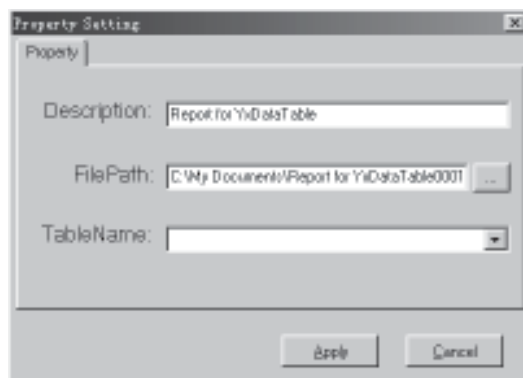

Fig. 8-26 Properties Modifying Dialogue Block

