	<p>PRESET COUNTER</p>	<h1 style="margin: 0;">LC2H Counters</h1>
---	----------------------------------	---

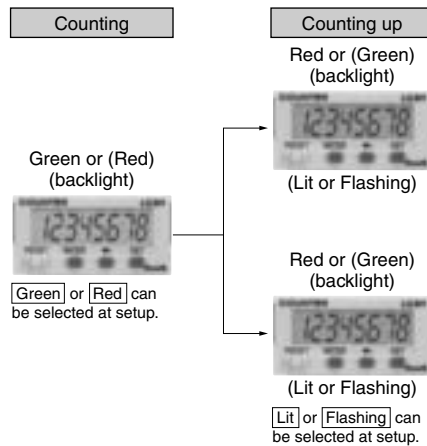

FEATURES



- 1. Preset function equipped in half size (24 × 48 mm 0.945 × 1.890 inch).**
- 2. Display has backlight for instant recognition.**



- 3. 8.7 mm 0.343 inch Character Height (previously 7 mm 0.276 inch)**
Easy-to read character height increased from 7 mm to 8.7 mm 0.276 inch to 0.343 inch.



- 4. Plenty of Digits**



- 5. Counting Speed Switchable between 30 Hz and 5 kHz**
- 6. Conforms to IP66 Protective Construction (Front panel surface)**
Weatherproofing supported by using optional mounting frame and rubber gasket
- 7. Includes reassuring lock mode and lock switch to prevent erroneous operation.**
- 8. Screw terminals are constructed to protect fingers to ensure safety.**
- 9. Complies with CE marking.**

PRODUCT TYPES

No. digits	Counting speed	Output mode	Output	Operating voltage	Part No.
8 digits	30 Hz/5 kHz switchable	<ul style="list-style-type: none"> Maintain output/hold count Maintain output/over count One shot/over count One shot/recount 	Transistor (1a)	24 V DC	LC2HP-FEW-B-DC24V
Options		Mounting frame	Use for waterproofing (front panel surface)		ATH3803
		Rubber gasket			ATH3804

Note: Mounting frame and rubber gasket are not included.

SPECIFICATIONS

Item		Descriptions
Rating	Rated operating voltage	24 V DC
	Rated power consumption	Max. 1.5 W
	Rated control capacity	100 mA 30 V DC
	Input mode	Addition/Subtraction (selectable by front switch)
	Max. counting speed	30 Hz/5 kHz (selectable by slide switch on side)
	Counting input	Min. input signal width: 16.7 ms at 30 Hz/0.1 ms at 5 kHz, ON time : OFF time = 1 : 1
	Reset input	Min. input signal width: Min. 30 ms
	Input signal	<ul style="list-style-type: none"> • Non-voltage input using contacts or open-collector connection • Input impedance; when shorted: Max. 1 kΩ, when open: Min. 100 kΩ • Residual voltage: Max. 2 V
	Output mode	<ul style="list-style-type: none"> • Maintain output/hold count • One shot/over count • One shot/recount (Selectable by front switch)
	Display method	7-segment LCD (Switch between red and green for backlight, and between lit and flashing for count up.)
	Digit	-9999999 to 99999999 (-7 digits to +8 digits) (0 to 99999999 for preset value)
Memory	EEP-ROM (Overwriting times: 1.0×10^5 operations or more)	
Contact arrangement		1 Form A (Open collector)
Electrical life (contact)		1.0×10^7 operations (at rated control voltage)
Electrical	Allowable operating voltage range	85 to 110% of rated operating voltage
	Break down voltage (Initial value)	Between input and output: 1,500 V AC, for 1 min.
	Insulation resistance (Initial value)	Between input and output: 100 MΩ (at 500 V DC)
Mechanical	Functional vibration resistance	10 to 55 Hz (1 cycle/min), Single amplitude: 0.15 mm 0.006 inch (10 min. on 3 axes)
	Destructive vibration resistance	10 to 55 Hz (1 cycle/min), Single amplitude: 0.375 mm 0.015 inch (1 hr. on 3 axes)
	Functional shock resistance	Min. 98 m/s ² (4 times on 3 axes)
	Destructive shock resistance	Min. 294 m/s ² (5 times on 3 axes)
Operating conditions	Operation temperature	-10 to 55°C +14 to +131°F (without frost or dew)
	Storage temperature	-25 to +65°C -13 to +149°F (without frost or dew)
	Ambient humidity	35 to 85% RH (non-condensing)
Protective construction		IP66 (front panel with mounting bracket and rubber gasket)

Part names

1. Front reset key

This key resets the count value. It does not work when the lock switch is ON.

2. Mode key

Use to switch between each mode.

3. Setting key

Used to set digits of preset values or set each mode.

4. Set key

Use to set preset values or to switch between modes.

5. Lock switch

Disable the operation of the front panel reset key and the mode key. With the lock switch on, Lock is displayed for about two seconds when the reset key or mode switch is operated.

6. Count speed switch

Use this switch to switch the count speed between 30 Hz and 5 kHz.

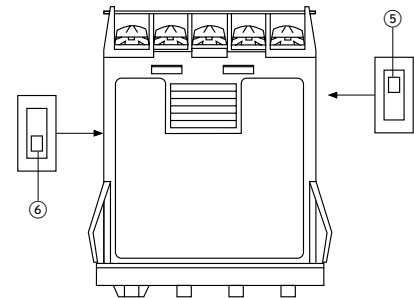
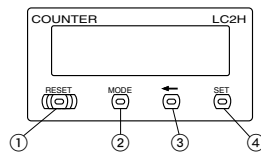

		*: Default setting when shipped.	
⑤	Lock switch (unit display 1)	(Terminal block side) ↑ (LCD side)	OFF* ↑ ON
⑥	Count speed switch (unit display 2)	(Terminal block side) ↑ (LCD side)	5kHz ↑ 30Hz*

Notes: 1. Make the switch setting before installing to panel.
2. Please turn the power off if you change the setting of the count speed switch when the power is on. The setting will become valid when the power is turned back on.

Dimensions

• External dimensions

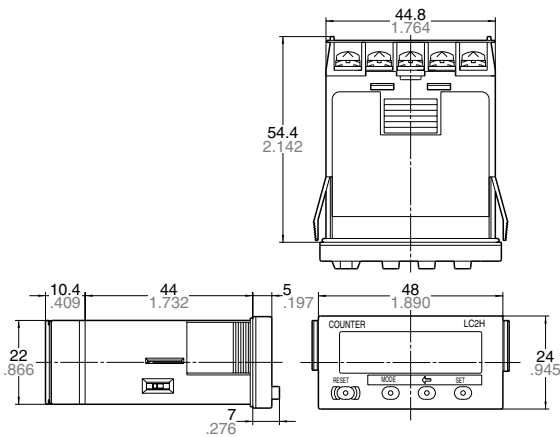

• Panel cut out dimensions

The standard panel cut out is shown below. Use the mounting bracket (ATH3803) and the rubber gasket (ATH3804). (Only installation frame type)

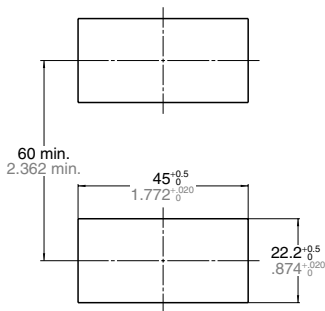

• When installing repeatedly (sealed installation) (Only installation frame type)

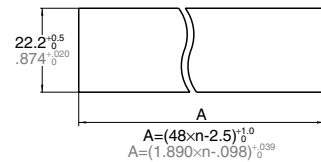

Notes: 1. Suitable installation panel thickness is 1 to 4.5 mm 0.39 to 0.177 inch.
2. Waterproofing will be lost when installing repeatedly (sealed installation).

How to set

1. Preset value setting mode

This is the mode for setting preset values.



1) Pressing the MODE key takes you to the preset value setting mode.

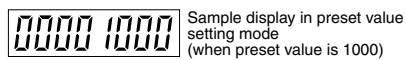

- Pressing the setting key moves the flashing digit left by one. Following the highest digit it returns to the lowest digit and each time the digit setting key is pressed it moves one to the left.
- Pressing the set key increases the value by one. (After 9 it returns to 0 and then changes to 1, 2, 3, etc.)
- Pressing the front panel reset key sets the displayed preset value and returns you to the regular operation mode.
- In the preset value setting mode if you do not operate the digit setting key or the set key for ten seconds or more you will be returned to regular operation. In this case the preset value will not change.

2. Lock mode

This mode prohibits everything except the preset value setting mode.



- Pressing the set key while holding down the mode key takes you to the lock mode.
- The display reads "Un-Lock" after entering the lock mode (initial setting).

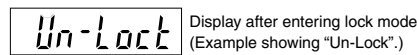

- Pressing the setting key changes the display between "Lock" and "Un-lock".

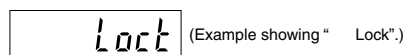

- Pressing the front panel reset key sets the content displayed and returns you to regular operation mode.

Note: You will not be returned to regular operation mode if you do not press the front panel reset key.

- When the lock mode display reads "Lock", you will not be able to move to the backlight setting mode, the input setting mode, or the output setting mode.

3. Backlight setting mode

This is the mode for setting the backlight during count up.

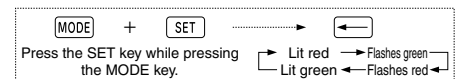

- Pressing the SET key two times while holding down the MODE key takes you to the backlight setting mode.
- The display in the backlight setting mode reads "LEd".



- The LED backlight will be red (initial setting).
- 23/
- The backlight changes from flashing green to flashing red to lit green and to lit red with each press of the setting key.
- Pressing the front panel reset key sets the current backlight color and returns you to regular operation mode.

Note: You will not be returned to regular operation mode if you do not press the front panel reset key.

4. Input setting mode

This is the mode for setting addition or subtraction.

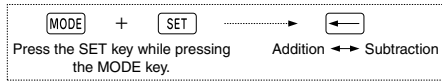

- 1) Pressing the SET key three times while holding down the MODE key takes you to the input setting mode.
- 2) The display after entering the input setting mode reads “UP” (initial setting).



- 3) Pressing the setting key changes the display to “dn” (subtraction) and pressing it again changes it to “UP” (addition). The display alternates between “dn” and “UP”.

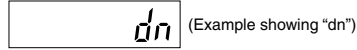

- 4) Pressing the front panel reset key sets the content displayed and returns you to regular operation mode.

Note: You will not be returned to regular operation mode if you do not press the front panel reset key.

5. Output setting mode

This sets the operation mode.

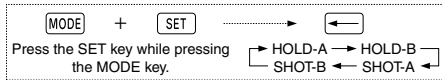

- 1) Pressing the SET key four times while holding down the MODE key takes you to the output setting mode.
- 2) The display reads “HoLd-A” (initial setting) after entering the output setting mode.

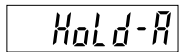

- 3) Pressing the setting key causes the display to change as follows:
HOLD-B (Output maintain/over count I)

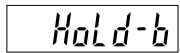

SHOT-A (One shot/over count)



SHOT-B (One shot/recount I)

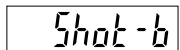

HOLD-A (Output maintain/hold count)

- 4) Pressing the front panel reset key sets the display content and returns you to regular operation mode.

Note: You will not be returned to regular operation mode if you do not press the front panel reset key.

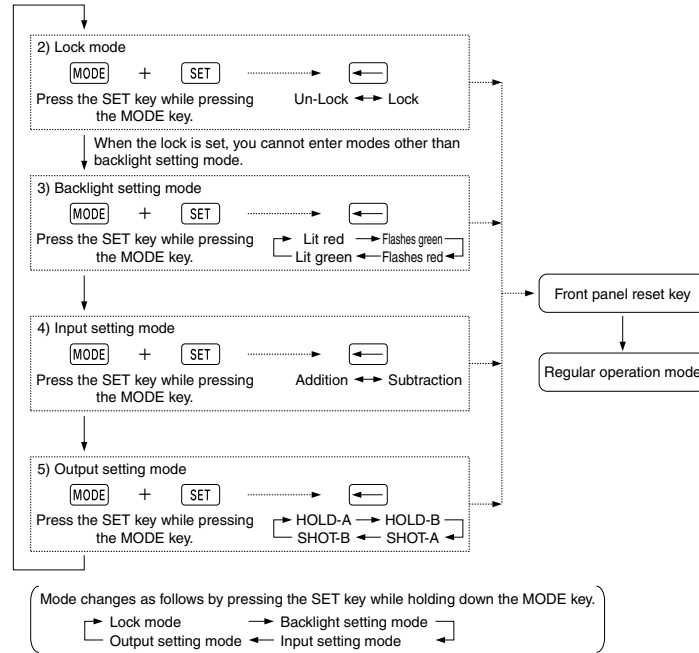

Please be aware that after doing a front panel reset key and returning to regular operation mode, the preset values, count value and output will be as shown in this table.

	Preset value	Count value	Output change
Lock mode	×	×	×
Backlight setting mode	×	×	×
Input setting mode	×	Addition: “0” Subtraction: “Preset value”	ON→OFF
Output setting mode	×	Addition: “0” Subtraction: “Preset value”	ON→OFF

Note: “x” sign: No change

Changing the preset value

1. It is possible to change the preset value even during counting. However, be aware of the following points.

- 1) If the preset value is changed to less than the count value with counting set to the addition direction, counting will continue until it reaches full scale, returns to zero, and then reaches the new preset value. If the preset value is changed to a value above the count value, counting will continue until the count value reaches the new preset value.

- 2) Suppose that the counter is preset to count down. Whether a preset count down value is smaller or larger than the count value, the counter counts down to “0 (zero)”.

2. If the preset value is changed to “0”, the counter will not complete count-up. It starts counting up when the counting value comes to “0 (zero)” again.

- 1) Addition (up-count) input when counting is set to the addition direction, counting will continue until full scale is reached, return to zero, and then complete count-up.
- 2) Subtraction (down-count) input when counting is set to the subtraction direction, counting will continue until full scale “-9999999” is reached, and then the display will change to “- - - - -”.

OPERATION MODE

Output mode	Operation	Example when input mode is either addition or Subject:ubtraction
Output maintain/ hold count HOLD-A	Output control is maintained after count-up completion and until resetting. During that time, the count display does not change from that at count-up completion.	<p>Output: OFF → ON Counting able/unable: ← Able → Unable →</p> <p>Addition: 0 1 2 3 4 ··· n-1 n</p> <p>Subtraction: n n-1 n-2 n-3 n-4 ··· 1 0</p> <p>n: Preset value</p>
Output maintain/ over count I HOLD-B	Output control is maintained after count-up completion and until resetting. However, counting is possible despite completion of count-up.	<p>Output: OFF → ON Counting able/unable: ← Able →</p> <p>Addition: 0 1 2 3 ··· n-2 n-1 n n+1 n+2 n+3</p> <p>Subtraction: n n-1 n-2 n-3 ··· 2 1 0 -1 -2 -3</p> <p>n: Preset value</p>
One shot/ over count SHOT-A	Output control is maintained after count-up completion for a fixed time (approx. 1 sec.). Counting is possible despite completion of count-up.	<p>Output: OFF → ON (One shot pulse width: approx. 1 sec.) Counting able/unable: ← Able →</p> <p>Addition: 0 1 2 3 ··· n-2 n-1 n n+1 n+2 n+3</p> <p>Subtraction: n n-1 n-2 n-3 ··· 2 1 0 -1 -2 -3</p> <p>n: Preset value</p>
One shot/ recount I SHOT-B	Output control is maintained after count-up completion for a fixed time (approx. 1 sec.). Counting is possible despite completion of count-up. However, reset occurs simultaneous with completion of count-up. While output is being maintained, restarting of the count is not possible.	<p>Output: OFF → ON (One shot pulse width: approx. 1 sec.) Counting able/unable: ← Able →</p> <p>Addition: 0 1 2 3 ··· n-1 0 1 2 3 4</p> <p>Subtraction: n n-1 n-2 n-3 ··· 1 n n-1 n-2 n-3 n-4</p> <p>n: Preset value</p>

Cautions for use

1. Input and output connection

1) Input connection

(1) Contact input

Use highly reliable metal plated contacts. Since the contact's bounce time leads directly to error in the count value, use contacts with as short a bounce time as possible. In general, select input to have a maximum counting speed of 30 Hz.

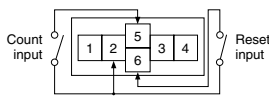

(2) Non-contact input (Transistor input)

Connect with an open collector. Use transistors whose characteristics satisfy the criteria given below.

VCEO = Min. 20 V

IC = Min. 20 mA

ICBO = Max. 6 μA

Also, use transistors with a residual voltage of less than 2 V when the transistor is on.

* The short-circuit impedance should be less than 1 kΩ.

(When the impedance is 0 Ω, the current coming from the count input terminal is approximately 5 mA and from the reset input terminal is approximately 1.5 mA.)

Also, the open-circuit impedance should be more than 100 kΩ.

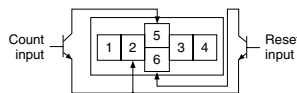

(3) Input wiring

When wiring, use shielded wires or metallic wire tubes, and keep the wire lengths as short as possible.

2) Output connection

Since the transistor output of counter is insulated from the internal circuitry by a photo-coupler, it can be used as an NPN output or PNP (equal value) output.

As NPN output

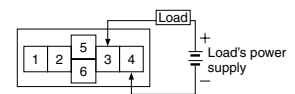

As PNP output

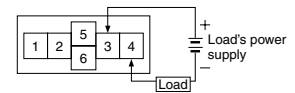

2. Self-diagnosis function

If a malfunction occurs, one of the following displays will appear.

Display	Contents	Output condition	Restoration procedure	Preset values after restoration
Err-00	Malfunctioning CPU	OFF	Enter front reset key or restart counter	The preset value at start-up before the CPU malfunction occurred.
Err-01	Malfunctioning memory*			0

* Includes the possibility that the EEPROM's life has expired.

3. Terminal connection

1) When wiring the terminals, refer to the terminal layout and wiring diagrams and be sure to perform the wiring properly without errors.

2) After turning the counter off, make sure that any resulting induced voltage or residual voltage is not applied to power supply terminals (1) through (2). (If the power supply wire is wired parallel to the high voltage wire or power wire, an induced voltage may be generated at the power supply terminal.)

3) Have the power supply voltage pass through a switch or relay so that it is applied at one time.

PRECAUTIONS IN USING THE LC2H SERIES

CAUTIONS FOR USE

1. Insulation sheet

Before using a panel mounting type, please pull and remove the insulation sheet from the side of the product in the direction of the arrow.

In consideration that the product might be stored for long periods without being used, an insulation sheet is inserted before shipping. Remove the insulation sheet and press the front reset button.

• LC2H total counter (one-touch installation type)

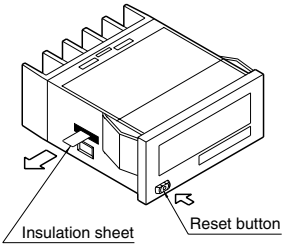

• LC2H total counter (installation frame type)

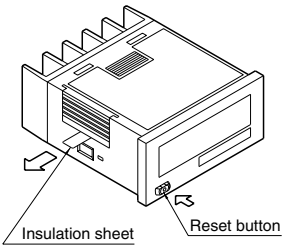

2. Waterproof construction

• LC2H total counter (installation frame type)

The operation part of the panel installation type (installation frame type) is constructed to prevent water from entering the unit and a rubber gasket is provided to prevent water from entering the gap between the unit and the panel cutout.

There must be sufficient pressure applied to the rubber gasket to prevent water from entering.

Be sure to use the mounting reinforcement screws when installing the mounting frame (ATH3803).

Note: The one-touch installation type is not waterproof.

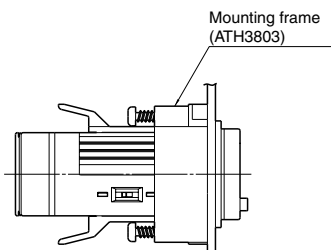

• LC2H preset counter

1) The front plate will not be waterproof when this product is installed on a panel. To make the front plate waterproof, please install the following.

When using the waterproof type (IP66: panel front only), install the counter to the front plate with mounting frame ATH3803 (sold separately) and rubber gasket ATH3804 (sold separately). Be sure to tighten using mounting screws.

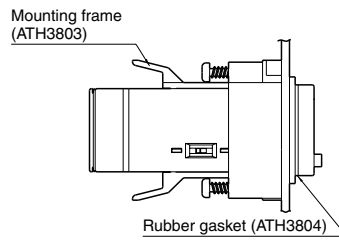

When installing the mounting frame and rubber gasket please remove the pre-attached o-ring.

2) Panel installation order

- (1) Remove o-ring.
- (2) Place rubber gasket.
- (3) Insert counter into panel.
- (4) Insert mounting frame from the rear.
- (5) Secure with mounting screws (two locations)

3. Do not use in the following environments

- 1) In places where the temperature changes drastically.
- 2) In places where humidity is high and there is the possibility of dew. (When dew forms the display may vanish and other display errors may occur.)

4. Conditions of use

- 1) Do not use on places where there is flammable or corrosive gas, lots of dust, presence of oil, or where the unit might be subject to strong vibrations or shocks.
- 2) Since the cover is made of polycarbonate resin, do not use in places where the unit might come into contact with or be exposed to environments that contain organic solvents such as methyl alcohol, benzene and thinner, or strong alkali substances such as ammonia and caustic soda.

5. Cautions regarding battery replacement

- 1) Remove wiring before replacing the battery. You may be electrocuted if you come into contact to a part where high voltage is applied.
- 2) Make sure you are not carrying a static electric charge when replacing the battery.
- 3) Battery replacement procedure
For LC2H total counter (one-touch installation type)
 - (1) Remove the up/down hook of the case using a tool.
 - (2) Pull the unit away from the case.
 - (3) Remove the battery from the side of the unit. Do not touch the display or other parts.
 - (4) Before inserting wipe clean the surface of the new battery.
 - (5) Insert the new battery with the "+" and "-" sides in the proper position.
 - (6) After replacing the battery, return the unit to the case. Verify that the hook of the case has properly engaged.
 - (7) Before using, press the reset button on the front.

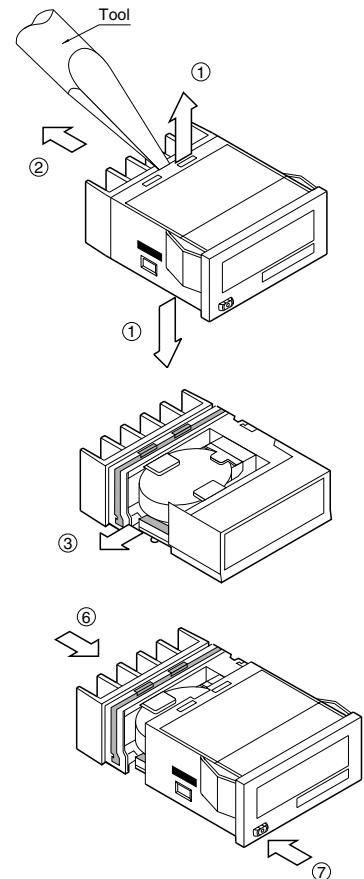

For LC2H total counter
(installation frame type)

- (1) Remove the battery cover from the case.
- (2) Remove the battery from the side of the case. The battery will come loose if you put the battery side face down and lightly shake the unit.
- (3) Before inserting wipe clean the surface of the new battery.
- (4) Insert the new battery with the “+” and “-” sides in the proper position.
- (5) After replacing the battery, return the battery cover to the case. Verify that the hook of the battery cover is properly engaged.
- (6) Before using press the reset button on the front.

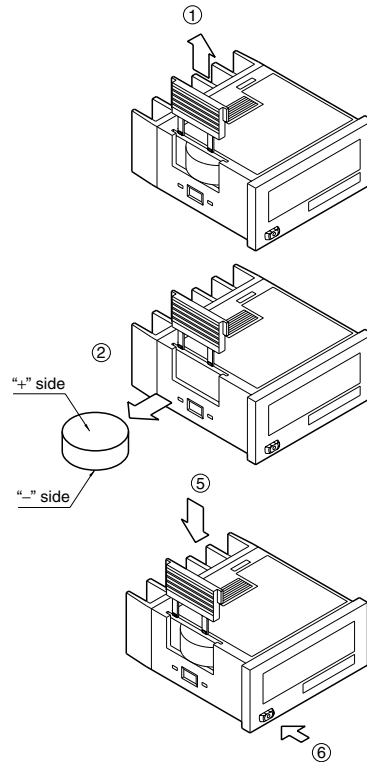

Options

1. Accessories (for LC2H total counter)

Panel cover (black)



Part No.: AEL3801

You can change the design of the front panel by replacing it with this black panel cover. The counter comes with an ash gray panel cover as standard.

Note: No panel cover accessory (black) is available for the LC2H preset counter.

2. Lithium battery (3 V)



Part No.: ATH3802

Packaged with the LC2H (excluding the PC board mounting type).

Warning

- Make sure the “+” and “-” polarities are positioned correctly.
- Do not throw the old battery into a fire, short circuit it, take it apart, or allow it to come into contact with heat.
- The battery is not rechargeable.

3. Installation parts

Mounting frame

(Suitable for installation frame type LC2H total counter and LC2H preset counter)

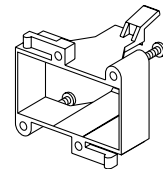

Part No.: ATH3803

Packaged with the mounting bracket type LC2H total counter

Rubber gasket

(Suitable for installation bracket type LC2H total counter and LC2H preset counter)



Part No.: ATH3804

Packaged with the mounting bracket type LC2H total counter