

**UL File No.: E122222**  
**CSA File No.: LR39291**

**FEATURES**

**1. Two-stage presetting (upper and lower limits)**

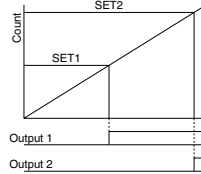

**2. Bright and Easy-to-Read Display**  
A brand new bright 2-color backlight LCD display. The easy-to-read screen in any location makes checking and setting procedures a cinch.

**3. Simple Operation**  
Seesaw buttons make operating the unit even easier than before.

**4. Short Body of only 64.5 mm 2.539 inch (screw type) or 70.1 mm 2.760 inch (pin type)**

With a short body, it easily installs in even narrow control panels.

**5. Conforms to IP66's Weather Resistant Standards**

The water-proof panel keeps out water and dirt for reliable operation even in poor environments.

**6. Screw terminal and Pin Type are Both Standard Options**

The two terminal types are standard options to support either front panel installation or embedded installation.

**7. Changeable Panel Cover**

Also offers a black panel cover to meet your design considerations.

**8. Conforms With EMC and Low Voltage Directives**

Conforms with EMC directives (EN50081-2/EN50082-2) and low-voltage directives (VDE0435/Part 2021) for CE certification vital for use in Europe.

**9. Low Price**

All this at an affordable price to provide you with unmatched cost performance.

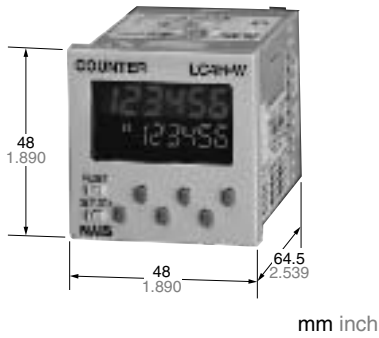

11-pin type



Screw terminal type

**PRODUCT TYPES**

Digit	Count speed	Output mode		Output	Operation voltage	Power down insurance	Terminal	Part No.	
		Output 1	Output 2						
6	30 Hz (cps)/ 5 KHz (Kcps) switchable	<ul style="list-style-type: none"> <li>Maintain output/over count I</li> <li>Maintain output/over count II</li> <li>Maintain output/over count III</li> <li>One shot/over count (4 modes)</li> </ul>	<ul style="list-style-type: none"> <li>Maintain output/hold count</li> <li>Maintain output/over count I</li> <li>Maintain output/over count II</li> <li>Maintain output/over count III</li> <li>One shot/over count</li> <li>One shot/recount I</li> <li>One shot/recount II</li> <li>One shot/hold count (8 modes)</li> </ul>	Relay (1a+1a)	100 to 240 V AC	Available	11 pin	LC4HW-R6-AC240V	
					24V AC / 24V DC		Screw	LC4HW-R6-AC240VS	
							12-24 V DC	11 pin	LC4HW-R6-AC24V
					100 to 240 V AC			Screw	LC4HW-R6-AC24VS
							Transistor (1a+1a)	24V AC / 24V DC	11 pin
					Screw				LC4HW-R6-DC24VS
				12-24 V DC	11 pin			LC4HW-T6-AC240V	
					Screw			LC4HW-T6-AC240VS	
				100 to 240 V AC	11 pin			LC4HW-T6-AC24V	
					Screw			LC4HW-T6-AC24VS	
				24V AC / 24V DC	11 pin		LC4HW-T6-DC24V		
					Screw		LC4HW-T6-DC24VS		

\* A rubber gasket (ATC18002) and a mounting frame (AT8-DA4) are included.

**PART NAMES**

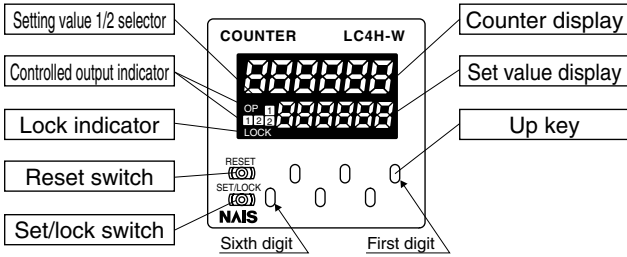

- UP keys** : Used to set the corresponding digits for the count-up mode.
- RESET key** : Used to reset counting and its output.
- SET/LOCK key** : Used to select between the Setting 1 display and Setting 2 display and to lock the keys (UP and RESET keys not responsive to touch). Used also to set and confirm the input mode.

**SPECIFICATIONS**

Item	Relay output type		Transistor output type		
	AC type	DC type	AC type	DC type	
Rating	Rated operating voltage	100 to 240 V AC 24 V AC <sup>1)</sup>	12 to 24 V DC	100 to 240 V AC 24 V AC <sup>1)</sup>	12 to 24 V DC
	Rated frequency	50/60 Hz common	—	50/60 Hz common	—
	Power consumption	Max. 10 V A	Max. 3 W	Max. 10 V A	Max. 3 W
	Control output	1 Form C: 3 A, 250 V AC (resistive)		1 Form A: 100 mA, 30 V DC Open collector output (Max.)	
	Input mode	Addition (UP)/Subtraction (DOWN)/Direction (DIR)/Individuality (IND)/Phase (PHASE) 5 modes selectable by DIP switch			
	Counting speed	30 Hz(cps)/5 KHz(cps) (selectable by DIP switch)			
	Min. counting input time	16.7 ms at 30 Hz(cps)/0.1 ms at 5 KHz(cps) ON time: OFF time = 1:1			
	Reset input method	Signal reset/Push-key switch, Min. input time 1 ms, 20 ms (selected by DIP switch)			
	Input signal	Contact or Open collector input/Input impedance: 1 kΩ or less, Input residual voltage: 2 V or less, Open impedance: 100 kΩ or more, Max. energized voltage: 40 V DC			
	Output mode	Output 1. HOLD-B, C, D SHOT-A (4 modes) Output 2. HOLD-A, B, C SHOT-A, B, C, D (8 modes) (selectable by DIP switch)			
	One shot output time	Approx. 1 s			
	Indication	7-segment LCD, Counter value (backlight red LED), Setting value (backlight yellow LED)			
	Digit	-99999 to 999999 (-5 digits to 6 digits) (0 to 999999 for setting)			
	Memory	EEP-ROM (Overwriting times: 10 <sup>5</sup> ope. or more)			
Contact	Contact arrangement	1a+1a	1a+1a (Open collector)		
	Initial contact resistance	100 mΩ (at 1 A 6 V DC)	—		
	Contact material	Ag alloy/Au flush	—		
Life	Mechanical	Min. 2.0 × 10 <sup>7</sup> ope.	—		
	Electrical	Min. 1.0 × 10 <sup>5</sup> ope. (At rated control voltage)	Min. 1.0 × 10 <sup>7</sup> ope. (At rated control voltage)		
Electrical	Operating voltage range	85 to 110 % of rated operating voltage			
	Initial withstand voltage	Between live and dead metal parts: 2,000 Vrms for 1 min (pin type) Between input and output: 2,000 Vrms for 1 min Between open contacts: 1,000 Vrms for 1 min	Between live and dead metal parts: 2,000 Vrms for 1 min Between input and output: 2,000 V AC for 1 min		
	Initial insulation resistance (At 500 V DC)	Between live and dead metal parts: Min. 100 MΩ (pin type) Between input and output: Min. 100 MΩ Between open contact: Min. 100 MΩ	Between live and dead metal parts: Min. 100 MΩ (pin type) Between input and output: Min. 100 MΩ		
	Temperature rise	Max. 65°C (under the flow of nominal operating current at nominal voltage)	—		
Mechanical	Vibration resistance	Functional	10 to 55 Hz (1 cycle/min), single amplitude: 0.35 mm .014 inch (10 min on 3 axes)		
		Destructive	10 to 55 Hz (1 cycle/min), single amplitude: 0.75 mm .030 inch (1 h on 3 axes)		
	Shock resistance	Functional	Min. 98 m 321.522 ft./s <sup>2</sup> (4 times on 3 axes)		
		Destructive	Min. 294 m 964.567 ft./s <sup>2</sup> (5 times on 3 axes)		
Operating conditions	Ambient temperature	-10°C to 55°C +14°F to +131°F			
	Ambient humidity	Max. 85 % RH			
	Air pressure	860 to 1,060 h Pa			
	Ripple rate	—	20 % or less	—	20 % or less
Connection	11-pin/screw terminal				
Protective construction	IP66 (front panel with a rubber gasket)				

Note: 1) the 24V AC type can be operated also with 24V DC.

# LC4H-W

## DIMENSIONS (units: mm inch) General tolerance: $\pm 1.0 \pm .039$

### • LC4H-W electrical counter

Screw-down terminal type  
(embedded installation)

Pin type (embedded installation/  
front panel installation)

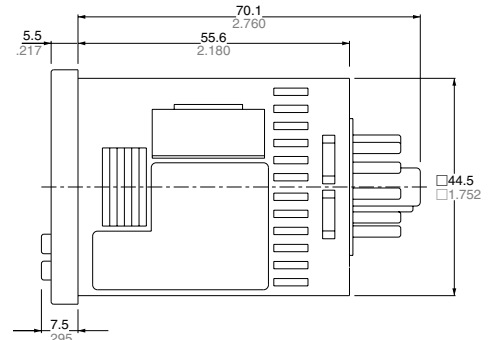
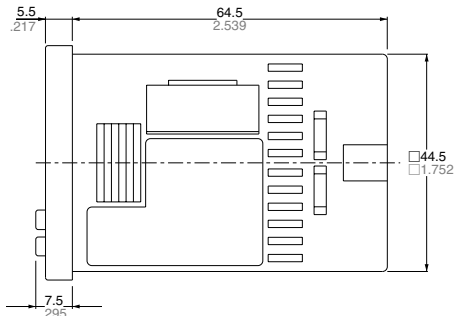
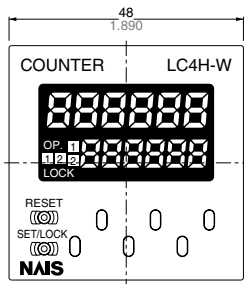

### • Dimensions for embedded installation (with adapter installed)

Screw-down terminal type

Pin type

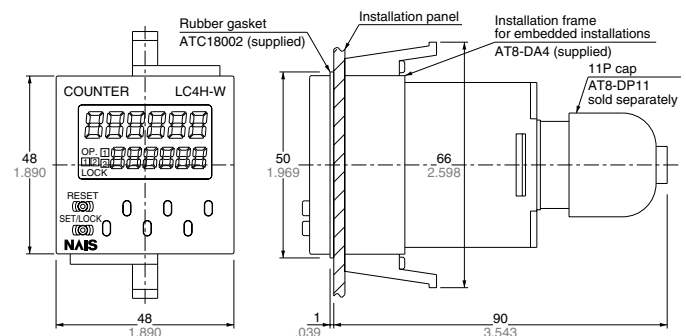
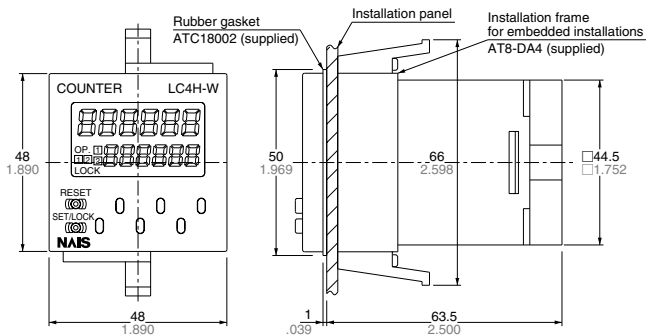

### • Dimensions for front panel installations

### • Installation panel cut-out dimensions

### • For connected installations

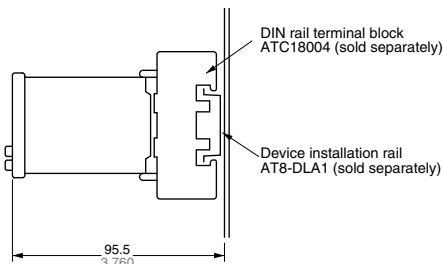

The standard panel cut-out dimensions are shown below. Use the installation frame (AT8-DA4) and rubber gasket (ATC18002).

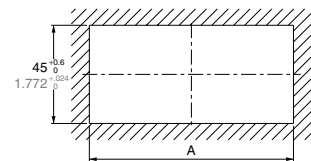
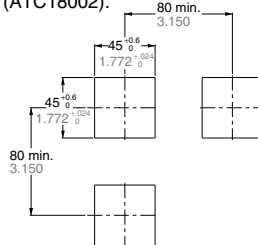

Note 1: The installation panel thickness should be between 1 and 5 mm (.039 and .197 inch).

Note 2: For connected installations, the waterproofing ability between the unit and installation panel is lost.

## TERMINAL LAYOUT AND WIRING

### • Pin type

Relay output type

Transistor output type

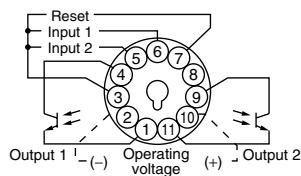
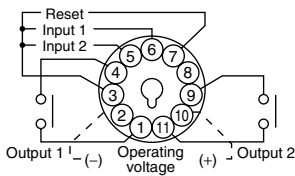

### • Screw-down terminal type

Relay output type

Transistor output type

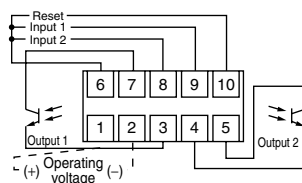
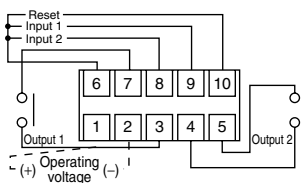

Note: For connecting the output leads of the transistor output type, refer to 6) Transistor output on page 99.

# SETTING THE OPERATION MODE AND COUNTER

The new settings are valid after power OFF → ON

## Setting procedure 1) Setting the output mode (output 1, 2)

Set the input 1, 2 modes with the DIP switches on the side of the unit.

### DIP switches

Item	OFF	ON
1		
2	Refer to table 1	
3	Output 1	
4	20ms	1ms
5	30Hz	5kHz
6		
7	Refer to table 2	
8	Output 2	

Table 1

Table 2

DIP switch No.			Output mode (Output 1)
1	2	3	
ON	ON	ON	—
OFF	OFF	OFF	HOLD-B
ON	OFF	OFF	HOLD-C
OFF	ON	OFF	HOLD-D
ON	ON	OFF	SHOT-A
OFF	OFF	ON	—
ON	OFF	ON	—
OFF	ON	ON	—

See note 1

See note 1

See note 1

See note 1

DIP switch No.			Output mode (Output 2)
6	7	8	
ON	ON	ON	HOLD-A
OFF	OFF	OFF	HOLD-B
ON	OFF	OFF	HOLD-C
OFF	ON	OFF	HOLD-D
ON	ON	OFF	SHOT-A
OFF	OFF	ON	SHOT-B
ON	OFF	ON	SHOT-C
OFF	ON	ON	SHOT-D

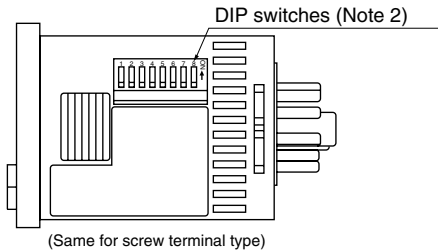

Note: 1) The elapsed time and set time displays both display "DIP Err."  
2) Set the DIP switches before installing the operation panel.

## Setting procedure 2) Setting the set value

Set the set value with the keys on the front of the unit.

### Front display section

- ① Counter display
- ② Set value display
- ③ Controlled output indicator
- ④ Setting 1/2 selection display
- ⑤ Lock indicator

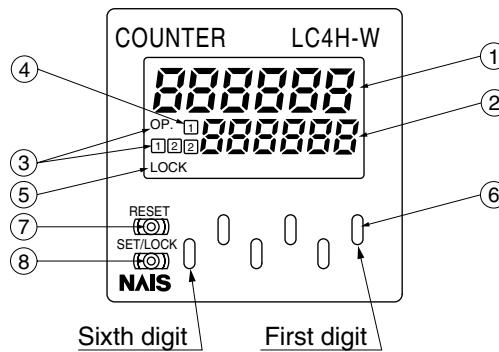

- ⑥ UP keys  
[Changes the corresponding digit of the set value in the addition direction (upwards)]
- ⑦ RESET switch  
Resets the set value and the output
- ⑧ SET/LOCK switch  
Used to select between the Setting 1 display and Setting 2 display, to set and confirm the input mode, and to lock the keys (UP and RESET keys not responsive to touch).

## Procedure 3) Setting the input mode

Set the input mode using the key switch in the front display section on the counter front.

- (1) Hold down the SET/LOCK key and press the UP key for the first digit. The setting mode is accessed.
- (2) Now release the SET/LOCK key.
- (3) Press the UP key for the first digit and the input position changes counterclockwise.

Example)  
Setting mode displayed (UP mode)

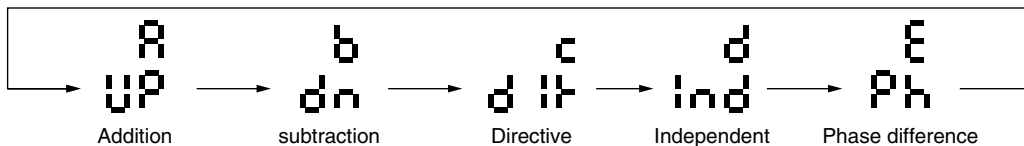
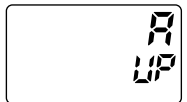

- (4) Press the RESET key and the input mode being displayed is set. The display then goes back to normal.

### • Checking the input mode

Hold down the SET/LOCK key and press the UP key for the second digit. The input mode is displayed for about 2 seconds and then the display goes back to normal. (During these 2 seconds, all operations other than the display are being performed.)

### • Locking the keys

Hold down the SET/LOCK key and press the UP key for the sixth digit. The keys will lock. This means that the UP and RESET keys do not respond to touch. To unlock the keys, hold down the SET/LOCK key and press the UP key for the sixth digit again.

\* The input mode, maximum counting speed and minimum reset signal width cannot be preset independently for Setting 1 and Setting 2.

### • Selecting the Setting 1 or Setting 2 display

Press the SET/LOCK key and the display changes between Setting 1 and Setting 2. (This operation does not affect overall operation.)

### • Changing the setting

1. While the counter is working, the UP key can be used to change the setting. Keep the following points in mind, however.

- 1) Suppose that a preset count-up value is smaller than the displayed count value. The counter counts up to the full scale mark (999999), goes back to "0", and counts up again to the preset number. When the preset count-up value is larger than the displayed count value, the counter counts up to the preset value.
- 2) Suppose that the counter is preset to count down. Whether a preset count-down value is smaller or larger than the count value, the counter counts down to "0".

2. When the preset value is "0", the counter does not start in the count-up mode. It starts counting up when the count value comes to "0" again.

- 1) Up-count input  
The counter counts up to the full scale mark (999999), goes back to "0" and starts counting up again.
- 2) Down-count input  
The counter counts down to the full scale mark (-99999) and the display reads - - - - -. The count value does not become "0" and so the counter does not count up.
- 3) Direction input, individual input, and phase input  
The preset value is counted up or down to any number other than "0" once. When it comes to "0" again, the counter starts counting up.

# OPERATION MODE

## 1. Input mode

① For the input mode, you can choose one of the following five modes.

- Addition UP
- Subtraction DOWN
- Directive DIR
- Independent IND
- Phase PHASE

② After the counter has been reset, Setting 2 is displayed in the count-down mode. "0" appears instead in all other modes.

Input mode	Operation	*Minimum input signal width 30 Hz: 16.7 ms; 5 kHz: 0.1 ms
Addition <span style="border: 1px solid black; padding: 2px;">UP</span>	IN1 or IN2 works as an input block (gate) for the other input.	<p>• Example where IN1 is the count input and IN2 is the input block (gate).</p> <p>Counting (addition)    0 1 2 3 ---- n-3 n-2 n-1 n</p> <p>Counting (subtraction)    n n-1 n-2 n-3 ---- 3 2 1 0</p> <p style="text-align: center;">△ Reset <span style="float: right;">△ Count UP</span></p>
Subtraction <span style="border: 1px solid black; padding: 2px;">DOWN</span>		<p>• Example where IN2 is the count input and IN1 is the input block (gate).</p> <p>Counting (addition)    0 1 2 3 4 ---- n-1 n</p> <p>Counting (subtraction)    n n-1 n-2 n-3 n-4 ---- 1 0</p> <p style="text-align: center;">△ Reset <span style="float: right;">△ Count UP</span></p>
Directive <span style="border: 1px solid black; padding: 2px;">DIR</span>	IN1 is the count input and IN2 is the addition or subtraction directive input. IN2 adds at L level and subtracts at H level.	<p>Counting    0 1 2 3 4 3 2 1 0 1 2 3 4</p> <p style="text-align: center;">△ Reset</p>
Independent <span style="border: 1px solid black; padding: 2px;">IND</span>	IN1 is addition input and IN2 is subtraction input.	<p>Counting    0 1 2 3 4 3 2 1 2 1 2 3</p> <p style="text-align: center;">△ Reset</p>
Phase <span style="border: 1px solid black; padding: 2px;">PHASE</span>	Addition when the IN1 phase advances beyond IN2, and subtraction when the IN2 phase advances beyond IN1.	<p>Counting    0 1 2 3 2 1 0</p> <p style="text-align: center;">△ Reset</p>

\* "A" must be more than the minimum input signal width.

\* "A" must be more than the minimum input signal width.

\* IN1 and IN2 are completely independent, so there is no restriction on signal timing.

\* "B" must be more than the minimum input signal width.

**2. Output mode**

For the set value 1, you can choose one of the following four modes.

- Maintain output/over count I HOLD-B
- Maintain output/over count II HOLD-C
- Maintain output/over count III HOLD-D
- One shot/over count SHOT-A

For the set value 2, you can choose one of the following eight modes.

- Maintain output/hold count HOLD-A
- Maintain output/over count I HOLD-B
- Maintain output/over count II HOLD-C
- Maintain output/over count III HOLD-D
- One shot/over count SHOT-A
- One shot/recount I SHOT-B
- One shot/recount II SHOT-C
- One shot/hold count SHOT-D

• Output mode for set value 1

Output mode	Operation	(Example when input mode is either addition or subtraction)
Maintain output Over count I <span style="border: 1px solid black; padding: 2px;">HOLD-B</span>	Output control is maintained after count-up completion and until resetting. However, counting is possible despite completion of count-up.	<p>* n: Set value 1</p>
Maintain output Over count II <span style="border: 1px solid black; padding: 2px;">HOLD-C</span>	Output control is maintained after count-up completion and until the next signal enters. However, counting is possible despite completion of count-up.	<p>* n: Set value 1</p>
Maintain output Over count III <span style="border: 1px solid black; padding: 2px;">HOLD-D</span>	If the count value is greater than or equal to the preset value when counting up, the control output is held. The count operation is possible anyway.	<p>* n: Set value 1</p>
One shot Over count <span style="border: 1px solid black; padding: 2px;">SHOT-A</span>	Output control is maintained after count-up completion for a fixed time (approx. 1 sec). Counting is possible despite completion of count-up.	<p>* n: Set value 1</p>

# LC4H-W

## • Output mode for set value 2

Output mode	Operation	(Example when input mode is either addition or subtraction)
Maintain output Hold count <b>HOLD-A</b>	Output control is maintained after count-up completion and until resetting. During that time, the count display does not change from that at count-up completion.	<p>* n: Set value 2</p>
Maintain output Over count I <b>HOLD-B</b>	Output control is maintained after count-up completion and until resetting. However, counting is possible despite completion of count-up.	<p>* n: Set value 2</p>
Maintain output Over count II <b>HOLD-C</b>	Output control is maintained after count-up completion and until the next signal enters. However, counting is possible despite completion of count-up.	<p>* n: Set value 2</p>
Maintain output Over count III <b>HOLD-D</b>	If the count value is greater than or equal to the preset value when counting up, the counter starts counting up again. The count operation is possible anyway.	<p>* n: Set value 2</p>
One shot Over count <b>SHOT-A</b>	Output control is maintained after count-up completion for a fixed time (approx. 1 sec). Counting is possible despite completion of count-up.	<p>* n: Set value 2</p>
One shot Recount I <b>SHOT-B</b>	Output control is maintained after count-up completion for a fixed time (approx. 1 sec). Counting is possible despite completion of count-up. However, reset occurs simultaneous with completion of count-up. While output is being maintained, restarting of the count is not possible.	<p>* n: Set value 2</p>

Output mode	Operation	(Example when input mode is either addition or subtraction)
One shot Recount II SHOT-C	Output control is maintained after count-up completion for a fixed time (approx. 1 sec). Counting is possible despite completion of count-up. However, reset occurs simultaneous with output OFF.	<p>* n: Set value 2</p>
One shot Hold count SHOT-D	Output control is maintained after count-up completion for a fixed time (approx. 1 sec). During that time, the count display does not change from that at count-up completion. Reset occurs simultaneous with output OFF.	<p>* n: Set value 2</p>

		Output mode for set value 1			
		HOLD-C	HOLD-D	HOLD-B	SHOT-A
Output mode for set value 2	SHOT-A	As usual (this combination unchanged)		As usual (this combination unchanged)	
	SHOT-B				
	SHOT-C SHOT-D				

Note: When control output 1 is on, the output mode of Setting 2 (SHOT-A, B, C, D) is also on and output 1 changes as shown in the above table.

**3. Count-up**

(1) In control output 1, when the count value is equal to the preset value 1, it is counted. (However, if the output mode of the preset value 1 is HOLD-D, it is counted when the count value is greater than or equal to the preset value 1, regardless of the input mode.)

(2) In control output 2, when the count value is equal to 0 in the count-down input mode, it is counted. In the other modes, when the count value is equal to the preset value 2, it is counted. (However, if the output mode of the preset value 2 is HOLD-D, it is counted when the count value is greater than or equal to the preset value 2, regardless of the input mode.)

(3) It is not counted even when the counting conditions are satisfied right after resetting. It can be counted from when the count value changes.



# LC4H series CAUTIONS FOR USE

## PRECAUTIONS DURING USAGE

### 1. Terminal wiring

1) When wiring the terminals, refer to the terminal layout and wiring diagrams and be sure to perform the wiring properly without errors.

2) For embedded installation applications, the screw-down terminal type is recommended.

Use either the rear terminal block (AT8-RR) or the 8P cap (AD8-RC) for the 8-pin type, and the 11P cap (AT8-DP11) for the 11-pin type. Avoid soldering directly to the round pins on the unit.

For front panel installation applications, use the 11-pin type DIN rail terminal block (ATC18004).

3) After turning the unit off, make sure that any resulting induced voltage or residual voltage is not applied to power supply terminals ② through ⑦ (8-pin type), ② through ⑩ (11-pin type) or ① and ② (screw-down terminal type). (If the power supply wire is wired parallel to the high voltage wire or power wire, an induced voltage may be generated between the power supply terminals.)

4) Have the power supply voltage pass through a switch or relay so that it is applied at one time. If the power supply is applied gradually, the counting may malfunction regardless of the settings, the power supply reset may not function, or other such unpredictable occurrence may result.

### 2. Input connections

The power circuit has no transformer. When an input signal is fed to two or more counters at once, do not arrange the power circuit in an independent way. If the counter is powered on and off independently as shown in Fig. A, the counter's internal circuitry may get damaged. Be careful never to allow such circuitry. (Figs. A, B and C show the circuitry for the 11-pin type.)

(Fig. A)  
Input contact point or transistor

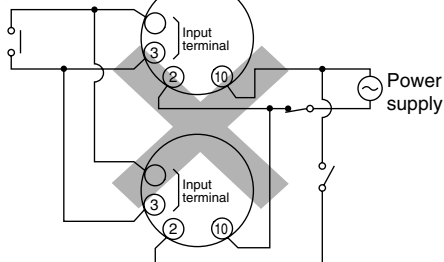

If independent power circuitry must be used, keep the input contacts or transistors separate from each other, as shown in Fig. B.

(Fig. B)

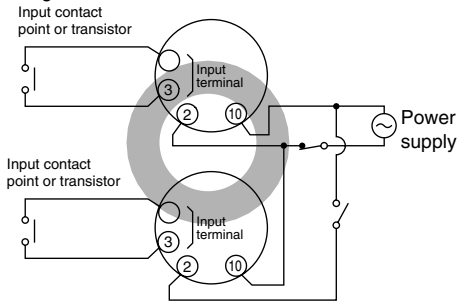

one input signal can be fed to two or more counters at once, as shown in Fig. C.

### 3. Input and output

(Fig. C)

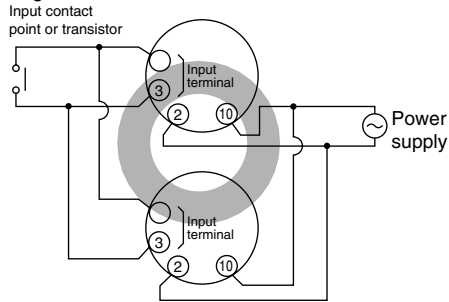

#### 1) Signal input type

##### (1) Contact point input

Use highly reliable metal plated contacts. Since the contact point's bounce time leads directly to error in the count value, use contacts with as short a bounce time as possible. In general, select Input 1 and Input 2 to have a maximum counting speed of 30 Hz and to be reset with a minimum input signal width of 20 ms.

##### (2) Non-contact point input

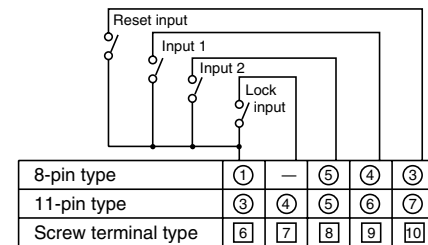

Note: The LC4H-W does not have the lock input ④ ⑦.

Connect with an open collector. Use transistors whose characteristics satisfy the criteria given below.

$V_{CE0} = 20 \text{ V min.}$

$I_C = 20 \text{ mA min.}$

$I_{CBO} = 6\mu\text{A max.}$

Also, use transistors with a residual volt-

age of less than 2 V when the transistor is on.

\* The short-circuit impedance should be

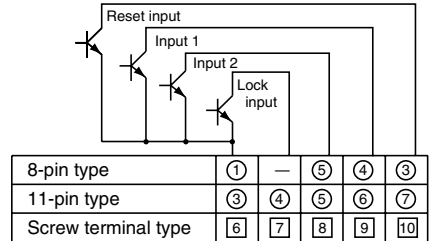

Note: The LC4H-W does not have the lock input ④ ⑦.

less than 1 k $\Omega$ .

[When the impedance is 0  $\Omega$ , the current coming from the input 1 and input 2 terminals is approximately 12 mA, and from the reset input and lock input terminals is approximately 1.5 mA.]

Also, the open-circuit impedance should be more than 100 k $\Omega$ .

\* As shown in the diagram below, from a non-contact point circuit (proximity switches, photoelectric switches, etc.) with a power supply voltage of between 12 and 40 V, the signal can be input without using an open collector transistor. In the case of the diagram below, when the non-contact point transistor Q switches from off to on (when the signal voltage goes from high to low), the signal is input.

#### 2) The input mode and output mode

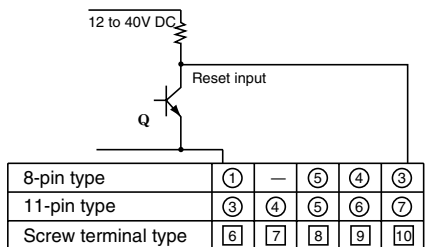

(The above example is for reset input)

change depending on the DIP switch settings. Therefore, before making any connections, be sure to confirm the operation mode and operation conditions currently set.

#### 3) For the power supply of the input

device, use a single-phase or double-phase insulated power transformer. The second-phase side must not be grounded.

4) Since the power supply circuitry does

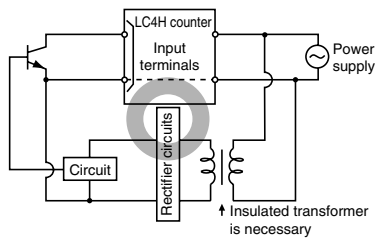

not contain a transformer, be aware that it is not possible for simultaneous input from an input contact point or transistor to a LC4H counter with independent power supply operation.

5) The input signal is applied by the shorting of each input terminal with the common terminal (terminal 1 for 8-pin type, terminal 3 for 11-pin type and terminal 6 for screw-down terminal types). Never connect other terminals or voltages higher than DC 40 V, because it may destroy the internal circuitry.

6) Transistor output

(1) Since the transistor output is insulated from the internal circuitry by a photo-coupler, it can be used as an NPN output or PNP (equal value) output. (The above example is 11-pin type)

(2) Use the diode connected to the out-

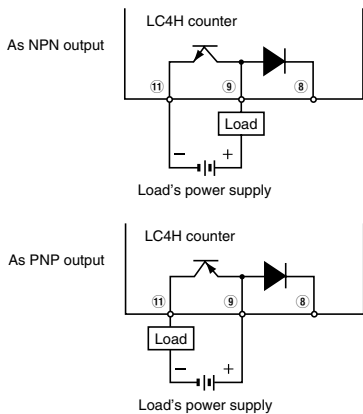

Note: With the LC4H 8-pin type and the LC4H-W, there is no diode between points ⑧ and ⑨.

put transistor's collector for absorbing the reverse voltage from induced loads. (LC4H only)

7) When wiring, use shielded wires or

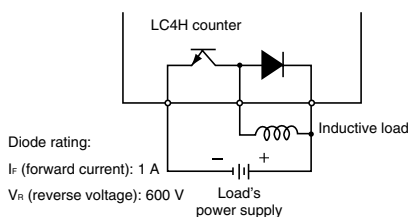

metallic wire tubes, and keep the wire lengths as short as possible.

#### 4. Output mode setting

The output mode can be set with the DIP switches on the side of the counter. Make the DIP switch settings before installing the counter on the panel.

#### 5. Conditions of usage

- 1) Avoid locations subject to flammable or corrosive gases, excessive dust, oil, vibrations, or excessive shocks.
- 2) Since the cover of the unit is made of polycarbonate resin, avoid contact with or use in environments containing methyl alcohol, benzene, thinners, and other organic solvents; and ammonia, caustic sodas, and other alkaline substances.
- 3) If power supply surges exceed the values given below, the internal circuits may become damaged. Be sure to use surge absorbing element to prevent this from happening.

Operating voltage	Surge voltage (peak value)
AC type	6,000V
DC type 24V AC type	1,000V

#### • Surge wave form

[± (1.2 × 50) ms uni-polar full wave voltage]

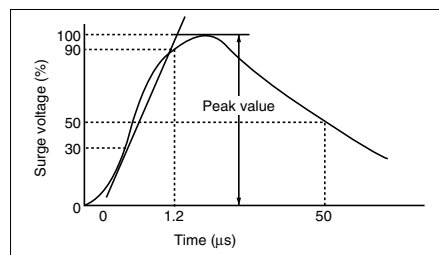

4) Regarding external noise, the values below are considered the noise-resistant voltages. If voltages rise above these values, malfunctions or damage to the internal circuitry may result, so take the necessary precautions.

	Power supply terminals		Input terminals
	AC type	DC type 24V AC type	
Noise voltage	1,500V	1,000V	600V

Noise wave form (noise simulator)

Rise time: 1 ns  
Pulse width: 1 μs, 50 ns  
Polarity: ±  
Cycle: 100 cycles/second

5) When connecting the operation power supply, make sure that no leakage current enters the counter. For example, when performing contact protection, if set up like that of diagram A, leaking current will pass through C and R, enter the unit, and cause incorrect operation. Diagram B shows the correct setup.

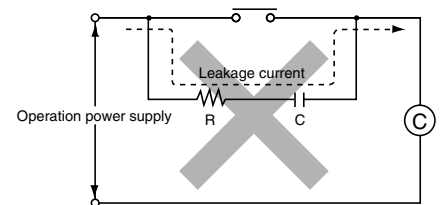

(Fig. A)

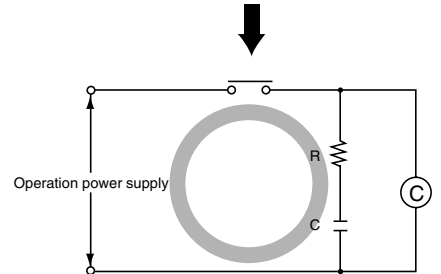

(Fig. B)

6) Long periods of continuous operation in the count-up completed condition (one month or more) will result in the weakening of the internal electrical components from the generated heat and, therefore, should be avoided. If you do plan to use the unit for such continuous operation, use in conjunction with a relay as shown in the circuit in the diagram below.

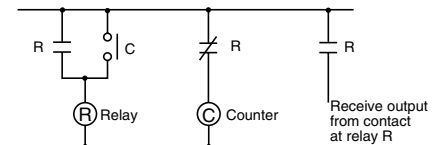

## 6. Self-diagnosis function

If a malfunction occurs, one of the following displays will appear.

Display	Contents	Output condition	Restoration procedure	Preset values after restoration
- - - - or - - - - -	Minimum value went below -999 or -99999. See note 1.	No change	Enter reset or RESET key.	No change
d IP E H	Incorrect DIP switch setting.		Restart unit (correct DIP switch settings)	
E H - 0 0	Malfunctioning CPU.	OFF	Enter reset, RESET key, or restart unit.	The values at start-up before the CPU malfunction occurred.
E H - 0 1	Malfunctioning memory. See note 2.			0

Note 1: When the counter value goes below the minimum value during any of the subtraction, directive, independent, or phase input modes.

Note 2: Includes the possibility that the EEPROM's life has expired.

## 7. CE Marking Certification

### 1) EMC directive (89/336/EEC)

As a counter unit, the LC4H series conforms to EMC directives. Applicable standards are EN50081-2 and EN50082-2.

### 2) Low voltage directive (73/23/EEC)

In order to satisfy VDE0435/Part 2021, be sure to adhere to the following installation conditions and precautions.

(1) The counter uses a non-transformer power supply and the power supply and input signal terminals are not insulated.

• When a sensor is connected to the

input circuit, install double insulation on the sensor side.

• With contact-point inputting, use double-insulated relays, etc.

(2) Always connect loads insulated with basic insulation specifications to the output contact points. The counter unit is also insulated with basic insulation specifications. The combination of the two satisfies VDE, which calls for double insulation.

(3) For the applied power supply, use one protected by an over-current protec-

tion device that conforms with EN/IEC standards (e.g. 250 V, 1 A fuse).

(4) During installation, always use a terminal block or the appropriate sockets.

Do not touch the terminals, or other part of the counter unit while it is on. Before installation or removal of the unit, first verify that no voltage is being applied to any of the terminals.

(5) Do not use the counter in a safety circuit. When the unit is being used in a circuit such as a heater circuit, install a protection circuit on the machine side.