



48 mm



Matsushita
Programmable Controller FP-e



FP-e Series

The universal compact PLC

Do this, do that, do everything. **All in One!**



3-color Display

Simple characters and numerical values can be displayed. Simple messages as well as timer/counter settings and elapsed values can also be displayed.

Built-in operation switch

Setting values can be changed. The operation switch can also be used as an input.

Compact

Panel mountable, little space is taken up on the control panel. The size is only 48 x 48 x 70 mm (behind faceplate).

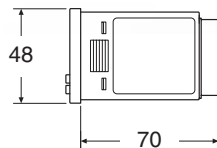

Matches FP0 intelligence (equivalent to FP0-C14)

Panel mounted type (in accordance with IP66, IEC standard)

To match panel design, a black faceplate is available.



Same programming tools used as with the FP Series

One programming software for all PLC types

Programming software and cables are common for all FP Series PLCs, so that any program created for the FP Series can be used by the FP-e as well. FPWIN Pro Ver.5 and FPWIN GR from Ver.2.3 offer a dialog to configure the screen display of the FP-e easily. You can check the result of the configuration directly with the display in the dialog.



FP-e Series

Optimised for a wide range of applications

Equipped with RS485 and RS232C interfaces

- Up to 99 computer link stations are possible with RS485. (RS485 type)

Up to 32 computer link stations are possible using a C-NET adaptor and up to 99 are possible using a commercially available adaptor. You can easily monitor operation status or perform control.

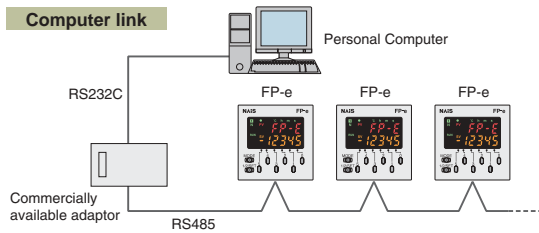

- With RS232C, communication with up to two ports is possible. (RS232C type)

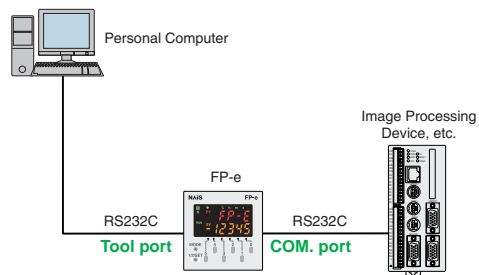

Can even handle temperature control

- Two-point K-type thermocouple (-30 to 300°C) connection is possible. (equipped with thermocouple input)

Can be used in place of a temperature controller or used to control them.

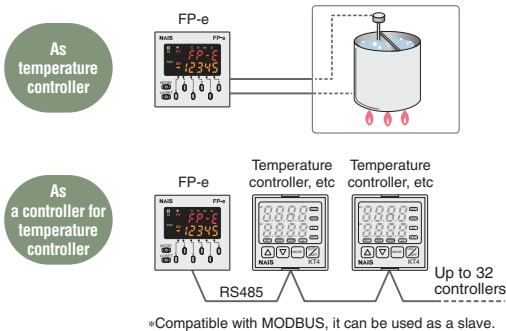

- PID instruction function

High-performance temperature control can be achieved with PID instruction.

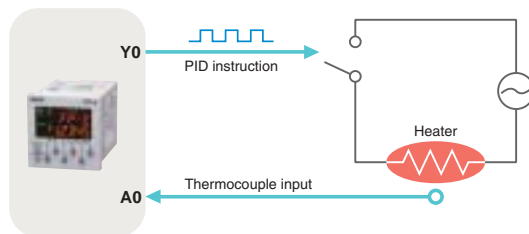

Equipped with high-speed counter for support of 2-axis independent positioning

- Pulse output function

The unit comes equipped with 2 channels for pulse output of up to 10 kHz pulses. Since these two channels can be separately controlled, the FP-e is also suitable for 2-axis independent positioning.

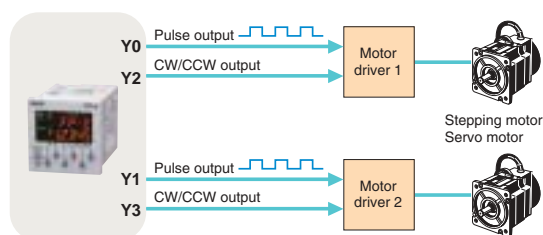

- High-speed counter function

In single phase, the 4-channel total is 10 kHz, and in 2-phase the 2-channel total is 2 kHz total speed, making the FP-e suitable for inverter control, etc.

(One half for the type with thermocouple input.)

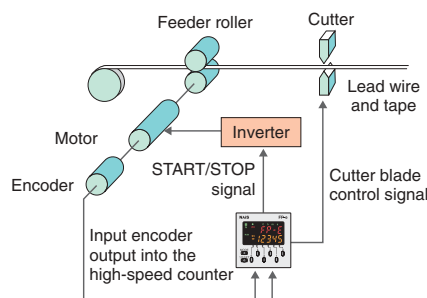



FP-e Control Units

Decisive advantages in its class

FP-e Control Unit

New Age, Advanced Controller!

Timer, Counter, Hour Meter, Temperature Controller and PLC in one Unit



■ Features

1. 5-character, 2-line, 3-color Display

Simple characters and numerical values can be displayed. Simple error messages as well as operation instructions and timer/counter set values can be displayed.

2. Front Operation Switch

Timer/Counter set values can be changed using front operation switches. The switches can also be used as input switches (X30 to X3F), so you need not install external switches.

3. Equivalent to FP0-C14 Intelligence of Small PLCs

In addition to the functions of programmable controller FP0, pulse output and high-speed counter functions can be used. The unit comes equipped with a tool port, and COM. port (RS232C/RS485) for communication.

4. Easy Programming Using Wizard

Screen display instructions can be easily created using a programming tool wizard in FPWIN GR Ver. 2.3. or FPWIN Pro Ver. 5.0.

5. Smooth Debugging

Monitoring memory area data and the I/O status facilitates debugging using the R (register) and I (I/O monitor) display modes.

6. Panel Mounted Type

The front of a unit is water-proof (in accordance with IP66, IEC standard).

■ Type

| Name | Type | Calendar timer | Thermocouple input | COM. port | Product No. |
|-------------------|----------------------------------|----------------|--------------------|-----------|-------------|
| FP-e control unit | Standard type (RS232C) | Not available | Not available | RS232C | AFPE224300 |
| | Calendar timer type (RS232C) | Available | Not available | RS232C | AFPE224305 |
| | Thermocouple input type (RS232C) | Available | Available | RS232C | AFPE214325 |
| | Standard type (RS485) | Not available | Not available | RS485 | AFPE224302 |
| | Thermocouple input type (RS485) | Not available | Available | RS485 | AFPE214322 |

■ Display modes and functions

1 N mode (Normal mode)

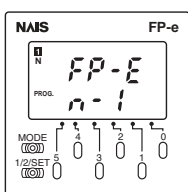

Displays characters and numerical values, numerical data can be changed.

2 S mode (Switch mode)

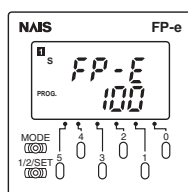

Can also display characters and numerical values. Operation switches can be used as inputs.

3 R mode (Register mode)

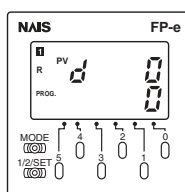

Operation memory in the controller can be monitored and its data changed.

4 I mode (I/O monitor mode)

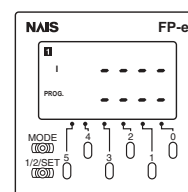

I/O status (X, Y) in the controller can be monitored.

FP-e Series

Specification table



Performance specifications

| Model | | AFPE224300 Standard type (RS232C) | AFPE224302 Standard type (RS485) | AFPE224305 Calendar timer type (RS232C) | AFPE214325 Thermocouple input type (RS232C) | AFPE214322 Thermocouple input type (RS485) |
|---|---|---|--|---|---|--|
| Item | | Relay symbol/Cyclic operation | | | | |
| Programming method/Control method | Control unit | 14 points [Input: 8, Output: 6 (Tr. NPN: 5/Ry: 1)] | | | 12 points [Input: 6, Output: 6 (Tr. NPN: 5/Ry: 1)] | |
| | Front switch input | 8 points | | | | |
| Number of controllable I/O points | Built-in memory | Built-in EEPROM | | | | |
| Program memory | | 2,720 steps | | | | |
| Program capacity | Basic | 83 | | | | |
| | High-level | 117 | | | | |
| Operation speed | | 0.9 μs/step (Basic instruction) | | | | |
| I/O update and Base time | | Typical 2 ms | | | | |
| Operation memory points | Relays | Internal relay (R) | | | | |
| | | Special internal relay (R) | | | | |
| | | Timer/Counter (T/C) | | | | |
| | Memory areas | 144 points (Initial setting: 100 timer points, T0 to T99/44 counter points, C100 to C143 ^{Note 1}) Timer range (1 ms, 10 ms, 100 ms, 1 s): selected by instruction | | | | |
| Data register (DT) | | | | | | |
| Special data register (DT) | | | | | | |
| | | Index registers (IX, IY) | | | | |
| Differential points | | Unlimited number of points | | | | |
| Master control relay points (MCR) | | 32 points | | | | |
| Number of labels (JP and LOOP) | | 64 labels | | | | |
| Number of step ladders | | 128 stages | | | | |
| Number of subroutines | | 16 subroutines | | | | |
| Number of interrupt programs | | 7 programs (external: 6, internal 1) | | | | |
| Self-diagnostic function | | Watchdog timer, program syntax check, etc. | | | | |
| Clock/calendar function ^{Note 2} | | Not available | | | Available (year, month, day, hour, minute, second and day of week). However, this can only be used when a battery has been installed. | |
| Battery life | | Not available | | | 220 days or more (actual usage value: approx. 870 days (25°C). (Periodic replacement interval: 1 year). (Value applies when no power is supplied at all.) | |
| Pulse catch input | | 6 points in total (X0 and X1: 50 μs, X2 to X5: 100 μs) | | | | |
| Interrupt input | | 6 points in total (X0 and X1: 50 μs, X2 to X5: 100 μs) | | | | |
| COM. port ^{Note 3} | | RS232C | RS485 | RS232C | RS232C | RS485 |
| Periodical interrupt | | 0.5 ms to 30 s | | | | |
| Constant scan | | Available | | | | |
| Password | | Available | | | | |
| Special functions | High-speed counter function | Counter mode: Addition/subtraction (1-phase) ^{Note 4} - Input points: 4 ch. (Max.) | | | | |
| | | - Max. speed: 10 kHz (total of 4 ch.) | | : 5 kHz (total of 4ch.) | | |
| | | - Input contact: X0: count input (ch. 0), X1: count input (ch. 1), X2: reset input ^{Note 5} X3: count input (ch. 2), X4: count input (ch. 3), X5: reset input ^{Note 5} | | | | |
| | | - Min. input pulse width: X0 and X1: 50 μs (10 kHz) | | X0 and X1: 100 μs (5 kHz) | | |
| | X3 and X4: 100 μs (5kHz) | | | | | |
| | Counter mode: 2-phase/individual/direction decision (2-phase) - Input points: 2 ch (Max.) | | | | | |
| | - Max. speed: 2 kHz (total of 2 ch.) | | : 1 kHz (total of 2ch.) | | | |
| | - Input contact: X0: count input (ch. 0), X1: count input (ch. 0), X2: reset input X3: count input (ch. 2), X4: count input (ch. 2), X5: reset input | | | | | |
| | - Min. input pulse width: X0 and X1: 50 μs (10 kHz) | | X0 and X1: 100 μs (5 kHz) | | | |
| | X3 and X4: 100 μs (5 kHz) | | | | | |
| Pulse output function | Output points | 2 independent points (Y0 and Y1) (No interpolation function) | | | | |
| | Output frequency | 40 Hz to 10 kHz (Y0/Y1: 1-point) ^{Note 6} | | | 40 Hz to 5 kHz (1-point) | |
| PWM output function | Output points | 40 Hz to 5 kHz (Y0/Y1: 2-point) | | | | |
| | Output frequency | 2 points (Y0 and Y1) | | | | |
| Timer | Output points | Frequency: 0.15 Hz to 1 kHz Duty: 0.1 % to 99.9 % | | | | |
| | Output frequency | Duty: 0.1 % to 99.9 % | | | | |
| Memory backup ^{Note 7} | Timer | Non-hold type: (all points) | | | | |
| | Counter | Non-hold type | From set value to C139 | | | |
| | Counter | Hold type | 4 points (elapsed values) C140 to C143 | | | |
| | Internal relay | Non-hold type | 976 points (R0 to R60F) | 61 words (WR0 to WR60) | | |
| Hold type | | 32 points (R610 to R62F) | 2 words (WR61 to WR62) | | | |
| Data register | Non-hold type | 1,652 words (DT0 to DT1651) | | | | |
| | Hold type | 8 words (DT1652 to DT1659) | | | | |

Note 1) The proportion of timer points to counter points can be changed using a system register.

Note 2) Precision of calendar timer:
 - At 0°C/32°F, less than 200 seconds of error per month
 - At 25°C/77°F, less than 70 seconds of error per month
 - At 55°C/131°F, less than 240 seconds of error per month

Note 3) When using the COM. port for communication, retransmission is recommended.
 The RS232C driver IC for the COM. port conforms completely to EIA/TIA-232E and CCITT V.28 standards

Note 4) The max. counting speed (10 kHz) is the counting speed with a rated input voltage of 24 V DC and an ambient temperature of 25°C. The counting speed (frequency) will decrease depending on the voltage and temperature.

Note 5) If the unit is equipped with both reset inputs X0 and X1, X2 serves as the reset input for X1. If X3 and X4 are used, X5 serves as the reset input for X4.

Note 6) When the positioning control instruction "F168" is performed, the maximum output frequency is 9.5 kHz.

Note 7) The program, system registers and the hold type area (internal relay, data register, and timer/counter) are backed up by the built-in EEPROM.
 When a battery is replaced with a new one in the FP-e unit with a calendar timer function, settings can be changed without installing a battery. The data cannot be stored even when the settings are changed using the system register.

Note 8) F180 (SCR) and F181 (DSP) instructions are supported from Control FFWIN GR Ver. 2.2. and FFWIN Pro V 4.1.



FP-e Series

Technical data

■ General specifications

| Item | Description | | |
|----------------------------------|---|---|--|
| Rated voltage | 24 V DC | | |
| Operating voltage range | 21.6 to 26.4 V DC | | |
| Allowed momentary power off time | 10 ms | | |
| Ambient temperature | 0 to +55°C | | |
| Storage temperature | -20 to +70°C | | |
| Ambient humidity | 30 to 85%RH (non-condensing) | | |
| Storage humidity | 30 to 85%RH (non-condensing) | | |
| Breakdown voltage | Input terminals (COM, X0 to Xn) Output terminals (Y0 to Y4) | Power supply terminal, Function earth Input terminal (A0, A1) COM. (RS232C) terminal | 500 V AC for 1 minute |
| | Output terminal (Y5) | Power supply terminal, Function earth Input terminal (COM, X0 to Xn, A0, A1) COM. (RS232C) terminal | 1500 V AC for 1 minute |
| | Input terminals (COM, X0 to Xn) | Output terminals (Y0 to Y4) | 500 V AC for 1 minute |
| Insulation resistance | Input terminals (COM, X0 to Xn) Output terminals (Y0 to Y5) | Power supply terminal, Function earth Input terminal (A0, A1) COM. (RS232C) terminal | Min. 100 M (measured with 500 V DC) |
| | Input terminals (COM, X0 to Xn) | Output terminals (Y0 to Y5) | |
| Vibration resistance | 10 to 55 Hz, 1 cycle/min. Double amplitude: 0.75 mm, 10 min. on X, Y, and Z axes | | |
| Shock resistance | 98 m/s ² or more, 4 times on X, Y, and Z axes | | |
| Noise resistance | 1000V (p-p) with pulse widths 50 ns and 1 μs (based on in-house measurements) | | |
| Operating condition | Free from corrosive gases and excessive dust | | |
| Current consumption | 200 mA or less (24 V DC) | | |
| Protection | IP66-compliant front section (Only when a rubber packing is used.) | | |
| Mass | Approx. 130 g | | |

■ DC input specifications (X0 to X7)

| Item | Description |
|--------------------------|---|
| Number of input | 8 points (6 points for thermocouple input type) |
| Insulation method | Optical coupler |
| Rated input voltage | 24 V DC |
| Operating voltage range | 21.6 to 26.4 V DC |
| Rated input current | Approx. 4.3 mA |
| Input points per common | 8 points/common (6 points/common for thermocouple input type) Either the positive or negative of the input power supply can be connected to common terminal. |
| ON voltage/ON current | 19.2 V or less/4 mA or less |
| OFF voltage/OFF current | 2.4 V or more/1 mA or more |
| Input impedance | Approx. 5.1 k (X0, X1) Approx. 5.6 k (X2 to X7) |
| Response time | 50 μs or less (X0, X1) ^{Note 1)} |
| | 100 μs or less (X2 to X5) ^{Note 1)} |
| | 2 ms or less (X6, X7) |
| | 50 μs or less (X0, X1) ^{Note 1)} |
| | 100 μs or less (X2 to X5) ^{Note 1)} |
| Operating mode indicator | LCD display (I/O monitor mode) |

Note 1) X0 through X5 are inputs for the high-speed counter and have a fast response time. If used as normal inputs, you should insert a timer in the program as chattering and noise may be interpreted as an input signal. Also, the above specifications apply when the rated input voltage is 24V DC and the temperature is 25°C.

■ Thermocouple input specifications

| Item | Description |
|--|--|
| Number of input | 2 points (CH0: WX1, CH1: WX2) |
| Temperature sensor type | Thermocouple type K |
| Input range | -30.0 to 300.0°C ^{*1)} (-22 to 572°F) |
| Accuracy | ±0.5%FS±1.5°C (FS = -30 to 300°C) |
| Resolution | 0.1°C |
| Conversion time | 250 ms/2CH ^{*2)} |
| Insulation method | Between internal circuit and thermocouple input circuit: noninsulated ^{*3)} Between CH0 and CH1 of thermocouple input: PhotoMOS insulation |
| Detection function of wire disconnection | Available |

*1) Temperature can be measured up to 330°C (626°F). When the measured temperature exceeds 330°C (626°F) or the thermocouple wiring is disconnected, "K20000" is written to the register.

*2) Temperature conversion for thermocouple input is performed every 250 ms. The conversion data is updated on the internal data register after the scan is completed.

*3) The internal circuit and thermocouple input circuit are not insulated. Therefore, use the nongrounding type thermocouples and sheath tubes.

FP-e Series

Technical data

■ Transistor NPN output specifications (For Y0 to Y4)

| Item | Description | |
|--|--------------------------------|---|
| Insulation method | Optical coupler | |
| Output type | Open collector | |
| Rated load voltage | 5 to 24 V DC | |
| Operating load voltage range | 4.75 to 26.4 V DC | |
| Max. load current | 0.5 A | |
| Max. surge current | 1 A | |
| Output points per common | 5 points/common | |
| OFF state leakage current | 100 μ A or less | |
| ON state voltage drop | 1.5 V or less | |
| Response time | OFF to ON | 50 μ s or less (For Y0 and Y1), 1 ms or less (For Y2, Y3 and Y4) |
| | ON to OFF | 50 μ s or less (For Y0 and Y1), 1 ms or less (For Y2, Y3 and Y4) |
| External power supply (For driving internal circuit) | Voltage | 21.6 to 26.4 V DC |
| | Current | 6 mA/point (For Y0 and Y1) 3 mA/point (For Y2, Y3, and Y4) |
| Surge absorber | Zener diode | |
| Operating indicator | LCD display (I/O monitor mode) | |

■ Relay output specifications (Y5)

| Item | Description | |
|--------------------------|--------------------------------|---|
| Output type | Normally open (1 Form A) | |
| Rated control capacity | 2 A 250 V AC, 2 A 30 V DC | |
| Output points per common | 1 point/common | |
| Response time | OFF to ON | Approx. 10 ms |
| | ON to OFF | Approx. 8 ms |
| Life time | Mechanical | Min. 2×10^7 operations |
| | Electrical | Min. 10^5 operations (resistive load) |
| Surge absorber | None | |
| Operating indicator | LCD display (I/O monitor mode) | |

■ COM. port communication specifications *1)

| Item | Description |
|--|--|
| COM. port type | RS232C *2) RS485 |
| Isolation status with the internal circuit | Non-isolated Isolated |
| Transmission distance | 15 m 1200 m |
| Baud rate *3) | 300, 600, 1200, 2400, 4800, 9600, 19200 bit/s 9600, 19200 bit/s *4) |
| Communication method | Half-duplex |
| Synchro system | Synchronous communication method |
| Transmission format | Stop bit: 1 bit/2 bit |
| | Parity: Not available/Available (Odd number/Even number) |
| | Data length 7 bit/8 bit |
| | Beginning code: STX available/STX not available |
| Data output order | Ending code: CR/CR+LF/not available/ETX |
| | Starting from 0 bits per character |
| No. of connected units | — 99 *5) *6) |
| Communication mode | <ul style="list-style-type: none"> • General-purpose communication • Computer link |

- *1) When communicating between FP-e and other devices, it is recommended to perform resend processing.
- *2) For RS232C wiring, be sure to use shielded wires for higher noise immunity.
- *3) Set the baud rate of RS485 with the FP-e system register and FP-e internal switch. Set the baud rate of RS232C with the FP-e system register.
- *4) When sending a command from the FP-e is completed in RS485 communication, send a response from the receiving device to the FP-e after the following time has elapsed: 9600 bit/s: 2 ms or longer 19200 bit/s: 1 ms or longer It takes at least 1 scan time (at least 2 ms) for the FP-e to send back a response after received the command.
- *5) When our C-NET Adapter or RS485 device other than recommended is connected in the system, the maximum connection number is limited to 32 units.
- *6) For a RS485 converter on the computer side, SI-35 (from LINE EYE Co., Ltd.) is recommended. When SI-35 is used in the system, up to 99 units can be connected.

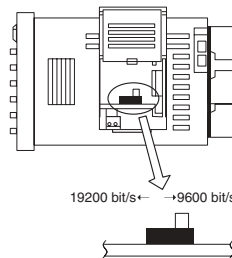

■ Dimensions

(mm)

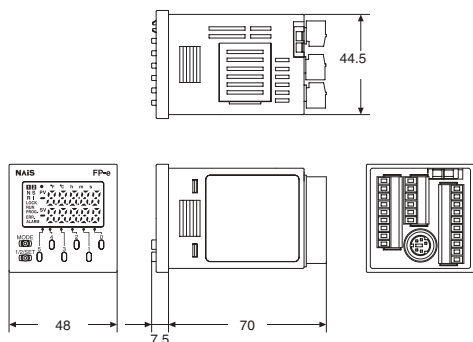

■ Wiring diagram

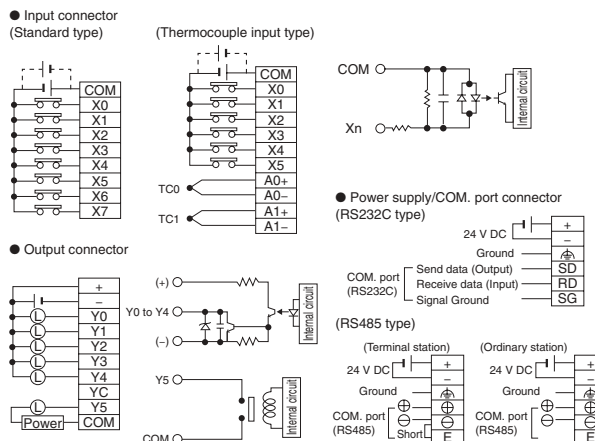

FP-e Options

Options

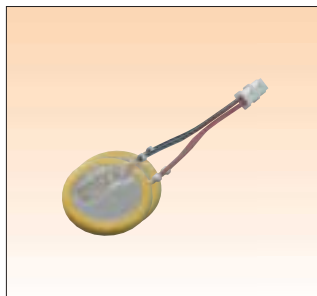

Backup battery
Included with calendar timer type

Part No.: **AFPG804**

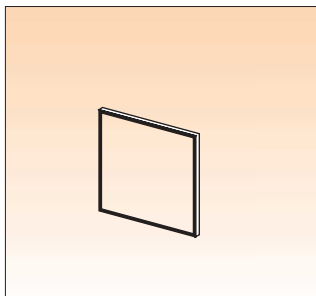

Rubber gasket
Included with unit

Part No.: **ATC18002**

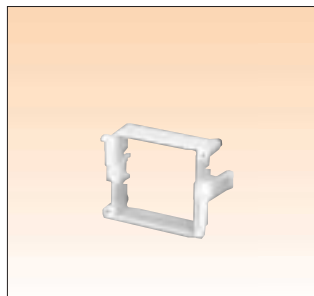

Mounting frame
Included with unit

Part No.: **AT8-DA4**

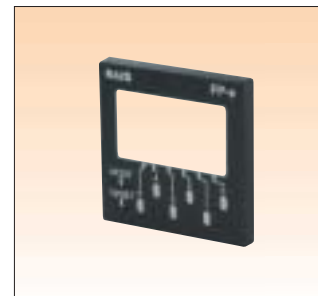

Panel cover
Color: Black

Part No.: **AFPE803** (20 sets)

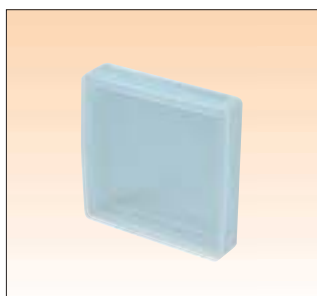

Protective cover

Part No.: **AQM4803**

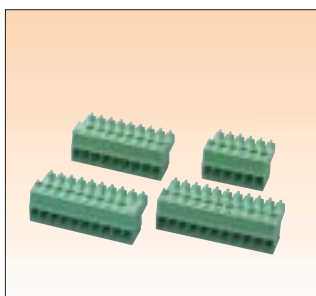

Terminal socket set
4 type sockets, additional part

Part No.: **AFPE804**

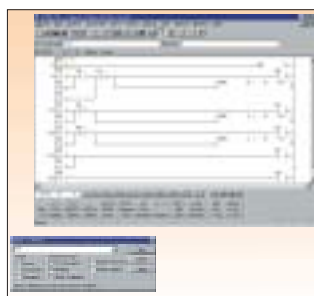

Programming tool software

Programming tool software Control FPCWIN Pro

Part No.: FPCWINPROSEN5
(Small version, English manual)
FPCWINPROSFR5
(Small version, French manual)
FPCWINPROSDE5
(Small version, German manual)
FPCWINPROFEN5
(Full version, English manual)
FPCWINPROFFR5
(Full version, French manual)
FPCWINPROFDE5
(Full version, German manual)

Control FPCWIN GR

Part No.: FPCWINGRF2 (Full version)

Programming cable

Part No.: **AFC8513**

Matsushita Electric Works

Please contact our Global Sales Companies in:

Europe

| | | |
|------------------|---|--|
| ▶ Europe | Matsushita Electric Works (Europe) AG | Rudolf-Diesel-Ring 2, D-83607 Holzkirchen, Tel. (08024) 648-0, Fax (08024) 648-111, www.mew-europe.com |
| ▶ Austria | Matsushita Electric Works Austria GmbH | Josef Madersperger Straße 2, A-2362 Biedermannsdorf, Tel. (02236) 26846, Fax (02236) 46133, www.matsushita.at |
| ▶ Benelux | Matsushita Electric Works Benelux B.V. | De Rijn 4, (Postbus 211), 5684 PJ Best, (5680 AE Best), Netherlands, Tel. (0499) 372727, Fax (0499) 372185, www.matsushita.nl or www.matsushita.be |
| ▶ France | Matsushita Electric Works France S.A.R.L. | B.P. 44, F-91371 Verrières le Buisson CEDEX, Tél. 01 60135757, Fax 01 60135758, www.matsushita-france.fr |
| ▶ Germany | Matsushita Electric Works Deutschland GmbH | Rudolf-Diesel-Ring 2, D-83607 Holzkirchen, Tel. (08024) 648-0, Fax (08024) 648-555, www.matsushita.de |
| ▶ Ireland | Matsushita Electric Works UK Ltd. | Irish Branch Office, Waverley, Old Naas Road, Bluebell, Dublin 12, Republic of Ireland, Tel: (01) 4600969, Fax: (01) 4601131, www.matsushita.ie |
| ▶ Italy | Matsushita Electric Works Italia s.r.l. | Via del Commercio 3-5 (Z.I. Ferlina), I-37012 Bussolengo (VR), Tel. (045) 6752711, Fax (045) 6700444, www.matsushita.it |
| ▶ Portugal | Matsushita Electric Works España S.A. | Portuguese Branch Office, Avda 25 de Abril, Edificio Alvorada 5ºE, 2750-512 Cascais, Portugal, Tel. (21) 4828266, Fax (21) 4827421 |
| ▶ Scandinavia | Matsushita Electric Works Scandinavia AB | Sjöängsvägen 10, 19272 Sollentuna, Sweden, Tel. (08) 59476680, Fax (08) 59476690, www.matsushita.se |
| ▶ Spain | Matsushita Electric Works España S.A. | Parque Empresarial Barajas, San Severo 20, 28042 Madrid, Tel. (91) 3293875, Fax (91) 3292976, www.matsushita.es |
| ▶ Switzerland | Matsushita Electric Works Schweiz AG | Grundstrasse 8, CH-6343 Rotkreuz, Tel. (041) 7997050, Fax (041) 7997055, www.matsushita.ch |
| ▶ United Kingdom | Matsushita Electric Works UK Ltd. | Sunrise Parkway, Linford Wood East, Milton Keynes, MK14 6LF, England, Tel. (01908) 231555, Fax (01908) 231599, www.matsushita.co.uk |

North & South America

| | | |
|-------|---|---|
| ▶ USA | Aromat Corporation Head Office USA | 629 Central Avenue, New Providence, N.J. 07974, Tel. 1-908-464-3550, Fax 1-908-464-8513, www.aromat.com |
|-------|---|---|

Asia

| | | |
|-------------|---|---|
| ▶ China | Matsushita Electric Works Ltd. China Office | 2013, Beijing Fortune, Building No. 5, Dong San Huan Bei Lu, Chaoyang District, Beijing, Tel. 86-10-6590-8646, Fax 86-10-6590-8647 |
| ▶ Hong Kong | Matsushita Electric Works Ltd. Hong Kong | Rm1601, 16/F, Tower 2, The Gateway, 25 Canton Road, Tsimshatsui, Kowloon, Hong Kong, Tel. (852) 2956-3118, Fax (852) 2956-0398 |
| ▶ Japan | Matsushita Electric Works Ltd. | 1048 Kadoma, Kadoma-shi, Osaka 571-8686, Japan, Tel. 06-6908-1050, Fax 06-6908-5781, www.mew.co.jp/e-acg/ |
| ▶ Singapore | Matsushita Electric Works (Asia Pacific) Pte. Ltd. | 101 Thomson Road, #25-03/05, United Square, Singapore 307591, Tel. (65) 6255-5473, Fax (65) 6253-5689 |