

FX-11A

Slim Body Analog Fiber Sensor

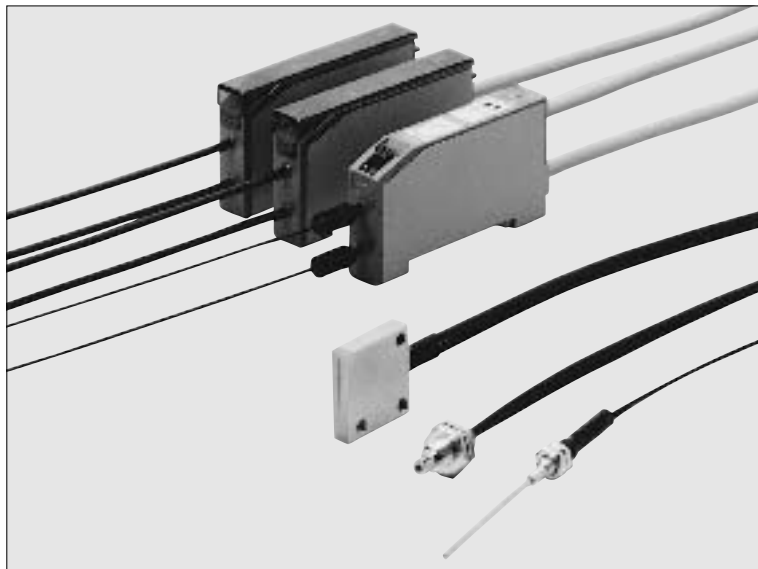

Analog Output Type for Diverse Applications

Analog Voltage Output

It incorporates an analog voltage output of 1 to 5V.

Various Uses

In combination with various types of fibers and the ultra-compact digital panel controller, **CA2 series, FX-11A** can be used for various applications, such as, height evaluation, level detection by differential sensing, etc.

Saturation Indicator

The saturation indicator lights up when the output reaches 5V. Hence, the sensitivity can be easily adjusted even without using a tester. Moreover, an incident beam indicator which brightens up in proportion to the amount of incident beam (output voltage) is also incorporated.



CA2 series

Digital panel controller

Incident beam indicator (Red)
Saturation indicator (Green)

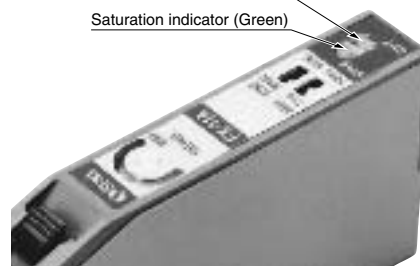

Interference Prevention Function

Two sets of fibers can be mounted close together or face to face.

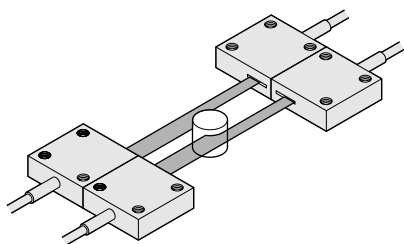

Slim Size

Being only 10mm thick, it can be mounted in a narrow space.

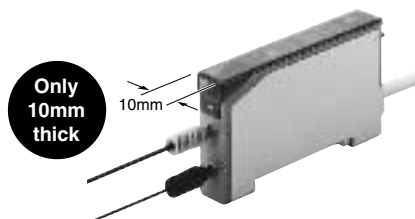

APPLICATIONS

Evaluating height of traveling objects

Objects can be sorted according to their height.

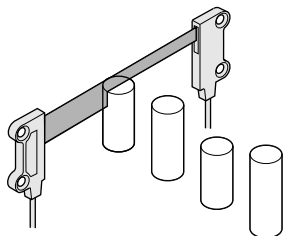

Detecting level difference

When differential sensing is used, no sensitivity readjustment is required even if the reflectivity of the objects changes.

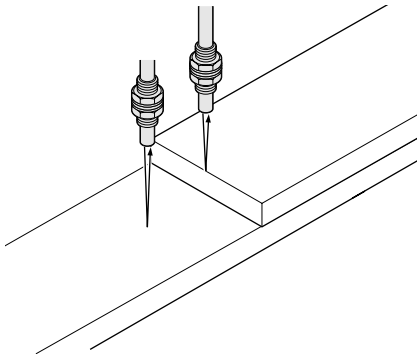

Detecting product mix-up

Mixed-up products that differ in color (reflectivity) can be sorted out from normal products.

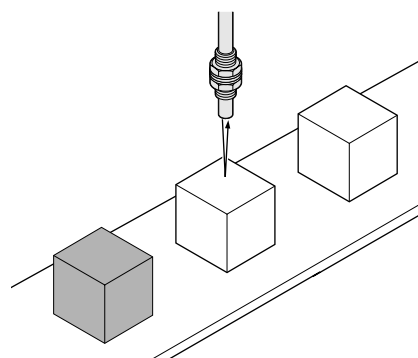

Ascertaining the number of translucent films

The number of overlapping translucent films can be ascertained.

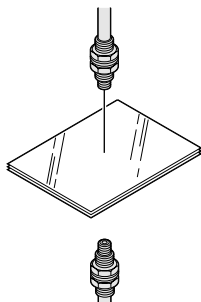

Sensing turbidity of liquid

The turbidity of a liquid inside a clear-wall tank can be sensed in an analog manner.

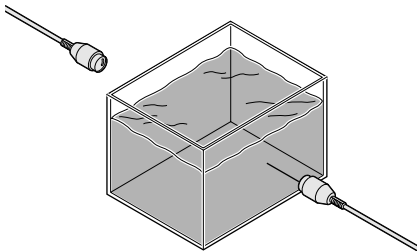

Measuring inner diameter of rings

Rings can be sorted according to their inner diameter.

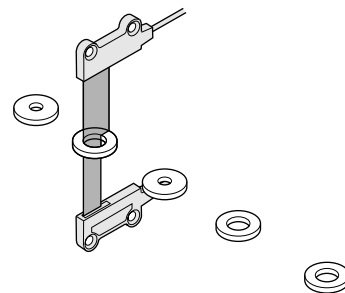













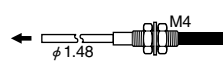

FX-11A

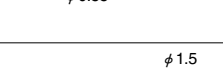
ORDER GUIDE

Amplifier

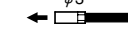
Appearance	Model No.	Supply voltage	Analog output
	FX-11A	12 to 24V DC \pm 10%	Analog voltage • Output voltage: 1 to 5V



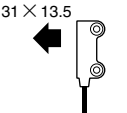
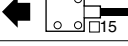
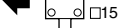



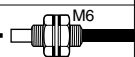
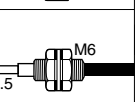

Fibers

Type	Shape of fiber head (mm)	Sensing range (Note 1)	Features	Fiber cable length	Model No.		
Thru-beam	Long sensing range Lens mountable	 160mm	• Twice the sensing range for the same diameter	Free Cut 2m	FT-B8		
	Standard	Lens mountable		• Free-cut type	Free Cut 2m	FT-FM2	
		With sleeve	 85mm			FT-FM2S With sleeve 90mm	
			FT-FM2S4 With sleeve 40mm				
			FT-SFM2				
	Small fiber head Lens mountable	 85mm	• Miniature head but having the same sensing range as the standard type fiber	Free Cut 2m	FT-T80		
	Small diameter		23mm	• Suitable for detection in a congested equipment • Free-cut type	Free Cut 2m	FT-NFM2	
		With sleeve				 23mm	FT-NFM2S With sleeve 90mm
						FT-NFM2S4 With sleeve 40mm	
						FT-SNFM2	
	Sharp bend	Standard Lens mountable	 35mm	• The fiber can be bent sharply, like an electric wire, to avoid space wastage in installation because of its small allowable bending radius of R1mm or more.	Free Cut 2m	NEW FT-W8	
			NEW FT-WS8				
		Small diameter M3	 8mm			NEW FT-W4	
			NEW FT-WS4				
	With lens	 100mm	NEW FT-WS8L				
Long sensing range with lens	 125mm	• Long sensing range with small fiber heads of φ2.5mm	Free Cut 2m	FT-SFM2L			
Wide beam	 100mm	• The wide beam detects an object at any place within the range.	Free Cut 2m	NEW FT-A8 (Note 2)			
Array	Top sensing	 65mm	• The wide beam detects an object at any place within the range.	Free Cut 2m	FT-AFM2		
	Side sensing	 65mm			FT-AFM2E		

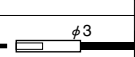
Notes: 1) The sensing range is defined as the range until the saturation indicator lights up.
2) The sensing width differs with the sensing object size and the sensing distance.
Please contact our office for details.

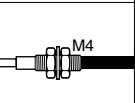
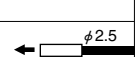
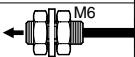
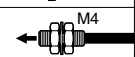
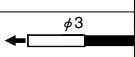
ORDER GUIDE

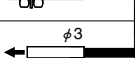
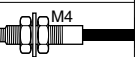
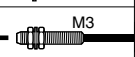
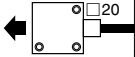
Fibers

Type	Shape of fiber head (mm)	Sensing range (Note)	Features	Fiber cable length	Model No.		
Reflective	Long sensing range	 31mm	• Long sensing range	Free Cut 2m	FD-B8		
	Standard	Coaxial	 22mm	• Free-cut type	Free Cut 2m	FD-FM2	
		With sleeve	 22mm			FD-FM2S With sleeve 90mm	
	Small fiber head		 22mm	• Miniature head but having the same sensing range as the standard type fiber	Free Cut 2m	FD-T80	
		Small diameter	 7mm			FD-T40	
			 22mm			FD-S80	
	Small diameter		 7mm	• Suitable for detection in a congested equipment • Free-cut type	Free Cut 2m	FD-NFM2	
		With sleeve	 7mm			FD-NFM2S With sleeve 90mm	
			 7mm			FD-SNFM2	
	Sharp bend	Standard	 8mm	• The fiber can be bent sharply, like an electric wire, to avoid space wastage in installation because of its small allowable bending radius of R1mm or more (FD-WG4, FD-WSG4: R2mm or more).	Free Cut 2m	NEW FD-W8	
		Small head				 8mm	NEW FD-WT8
						 8mm	NEW FD-WS8
		High precision	Lens mountable Coaxial			 3mm	NEW FD-WG4
			Coaxial			 3mm	NEW FD-WSG4
	High precision	Lens mountable Coaxial	 10mm	• Precise position sensing	Free Cut 2m	FD-G4	
		Lens mountable Coaxial • Small head	 3mm	• Combination with the FX-MR3 lens gives an extremely small spot diameter of $\phi 0.3$ mm approx.	500mm	FD-EG1	
	Array	Top sensing	 20mm	• Its wide beam meets various needs.	Free Cut 2m	FD-AFM2	
		Side sensing	 13mm			FD-AFM2E	

Note: The sensing range is defined as the range until the saturation indicator lights up.

Further, for the reflective type fibers, it is specified for white non-glossy paper [50 × 50mm (**FD-B8**: 100 × 100mm)] as the object.

FX-11A

OPTIONS

Designation		Model No.	Description
For thru-beam type fiber	Expansion lens	FX-LE1	Increases the sensing range by 6 times or more. • Sensing range (Lens on both sides) (Note 1): 900mm (FT-B8), 750mm (FT-FM2 , FT-T80), 350mm (FT-W8)
	Super-expansion lens	FX-LE2	Tremendously increases the sensing range with large aperture lenses. • Sensing range (Lens on both sides) (Note 1): 3,000mm (FT-B8), 2,500mm (FT-FM2), 3,000mm (FT-W8)
	Side-view lens	FX-SV1	Beam axis is bent by 90°. • Sensing range (Lenses on both sides) (Note 1) : 220mm (FT-B8), 200mm (FT-FM2 , FT-T80), 25mm (FT-W8)
For reflective type fiber	Pinpoint spot lens	FX-MR1	Pinpoint spot of $\phi 0.5$ mm. • Applicable fiber: FD-WG4 , FD-G4 • Distance to focal point: 6 ± 1 mm
	Zoom lens	FX-MR2	The spot diameter is adjustable from $\phi 0.7$ to $\phi 2$ mm according to how much the fiber is screwed in. • Applicable fiber: FD-WG4 , FD-G4 • Distance to focal point: 18.5 to 43mm approx. (Screw-in depth: 7 to 14 mm) • Spot diameter: $\phi 0.7$ to $\phi 2$ mm (Screw-in depth: 7 to 14mm)
	Finest spot lens	FX-MR3	Extremely fine spot of $\phi 0.3$ mm is achieved. • Applicable fiber: FD-WG4 , FD-EG1 , FD-G4 • Distance to focal point: 7.5 ± 0.5 mm • Spot diameter: $\phi 0.3$ mm (FD-EG1), $\phi 0.5$ mm (FD-WG4 , FD-G4)
Digital panel controller	CA2-T2	NPN open-collector transistor	This is a very small controller which allows two independent threshold level settings. • Supply voltage: 24V DC $\pm 10\%$ • No. of inputs: 1 No. (sensor input) • Input range: 1 to 5V DC • Main functions: Threshold level setting function, zero-adjust function, scale setting function, hysteresis setting function, start/hold function, auto-reference function, power supply ON-delay function, etc.

Expansion lens Super-expansion lens



Side-view lens Pinpoint spot lens



Zoom lens Finest spot lens

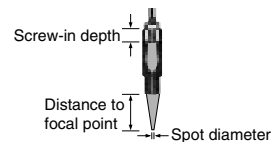

Digital panel controller • CA2 series



Notes: 1) The sensing range is defined as the range until the saturation indicator lights up.

SPECIFICATIONS

Fibers

Item \ Type	Type
	Standard, small fiber head, small diameter, sharp bend, long sensing range with lens, wide beam, array, high precision
Allowable bending radius	R25mm or more [Sharp bend: R1mm or more (FD-WG4 , FD-WSG4 : R2mm or more)]
Ambient temperature	- 40 to + 70°C (Sharp bend: - 40 to + 60°C, FD-EG1 : - 20 to + 60°C) (No dew condensation or icing allowed), Storage: - 40 to + 70°C (Sharp bend: - 40 to + 60°C, FD-EG1 : - 20 to + 60°C)
Ambient humidity	35 to 85% RH, Storage: 35 to 85% RH
Material	Fiber core: Acrylic Sheath: Polyethylene Fiber head: Brass (Nickel-plated) (Threaded part of standard, threaded part of small diameter, threaded type of sharp bend, high precision, array) Stainless steel (SUS) (FT-SFM2 , small fiber head, FT-SNFM2 , FD-SNFM2 , non-threaded type of sharp bend, FT-SFM2L , sleeve part of sleeve-attached fiber) Polycarbonate (FT-A8 , Lens of FT-WS8L), Polyolefin (Lens of FT-A8)
Accessories	Threaded head fiber: 2 Nos. of nuts (thru-beam type: 4 Nos.) and 1 No. of toothed lock washer (thru-beam type: 2 Nos.) Free-cut type fiber: 1 No. of FX-CT1 (Fiber cutter) FD-WG4 , FD-WSG4 or FD-G4 : ϕ 1mm fiber attachment and ϕ 1.3mm fiber attachment Small diameter free-cut type fiber: ϕ 1mm fiber attachment FT-T80 , FD-T80 or FD-S80 : ϕ 1.3mm fiber attachment FT-WS4 , FD-WT8 , FD-WS8 : FX-AT10 (ϕ 1mm fiber attachment) FT-A8 : 2 Nos. of 0.5 X 12mm seal type slit mask and 2 Nos. of 1 X 12mm seal type slit mask

Amplifier

Item \ Model No.	Model No.	
	FX-11A	
Supply voltage	12 to 24V DC \pm 10% Ripple P-P 10% or less	
Current consumption	35mA or less	
Analog output	Analog voltage <ul style="list-style-type: none"> • Output voltage: 1 to 5V (proportional to incident light intensity) • Output current: 5mA or less • Output impedance: 47Ω • Load resistance: 2kΩ or more • Temperature characteristics: 0.3% F.S. /°C or less 	
Response time	Switchable either 1ms or less, or 10ms or less	
Incident beam indicator	Red LED (brightens up in proportion to analog output voltage)	
Saturation indicator	Green LED (lights up when the analog output voltage reaches 5V)	
Sensitivity adjuster	8-turn potentiometer with indicator	
Interference prevention function	Incorporated	
Environmental resistance	Ambient temperature	- 10 to + 55°C (No dew condensation or icing allowed), Storage: - 20 to + 70°C
	Ambient humidity	35 to 85% RH, Storage: 35 to 85% RH
	Ambient illuminance	Sunlight: 1,000 lx at the light-receiving face, Incandescent light: 1,000 lx at the light-receiving face
	Noise immunity	Power line: 240Vp, 10ms cycle, and 0.5 μ s pulse width; Radiation: 300Vp, 10ms cycle, and 0.5 μ s pulse width (with noise simulator)
	Voltage withstandability	1,000V AC for one min. between all supply terminals connected together and enclosure (Note 1)
	Insulation resistance	20M Ω , or more, with 250V DC megger between all supply terminals connected together and enclosure (Note 1)
	Vibration resistance	10 to 150Hz frequency, 0.75mm amplitude in X, Y and Z directions for two hours each
Shock resistance	100m/s ² acceleration (10G approx.) in X, Y and Z directions for five times each	
Emitting element	Red LED (modulated)	
Material	Enclosure: Heat-resistant ABS, Cover: Polycarbonate, Fiber lock lever: PES	
Cable	0.2mm ² 4-core cabtyre cable, 2m long	
Cable extension	Extension up to total 100m is possible with 0.3mm ² , or more, cable. (Note 2)	
Weight	60g approx.	
Accessories	MS-DIN-2 (Amplifier mounting bracket): 1 No., Adjusting screwdriver: 1 No.	

Notes: 1) The voltage withstandability and the insulation resistance values given in the above table are for the amplifier only.
 2) Take care that the output voltage drops when the cable is extended.

FX-11A

I/O CIRCUIT AND WIRING DIAGRAMS

I/O circuit diagram

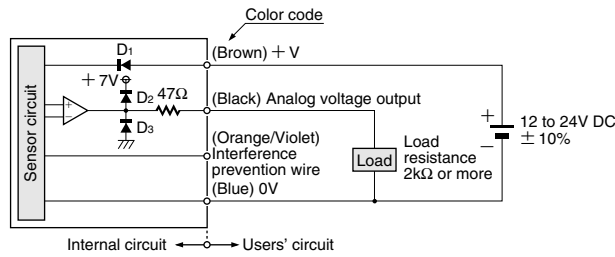

Wiring diagram

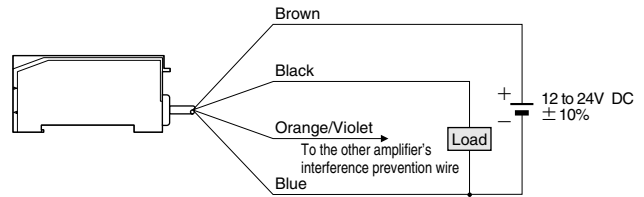

Symbols ... D1: Reverse supply polarity protection diode
D2, D3: Surge absorption diode

SENSING CHARACTERISTICS (TYPICAL)

Correlation between setting distance and output voltage

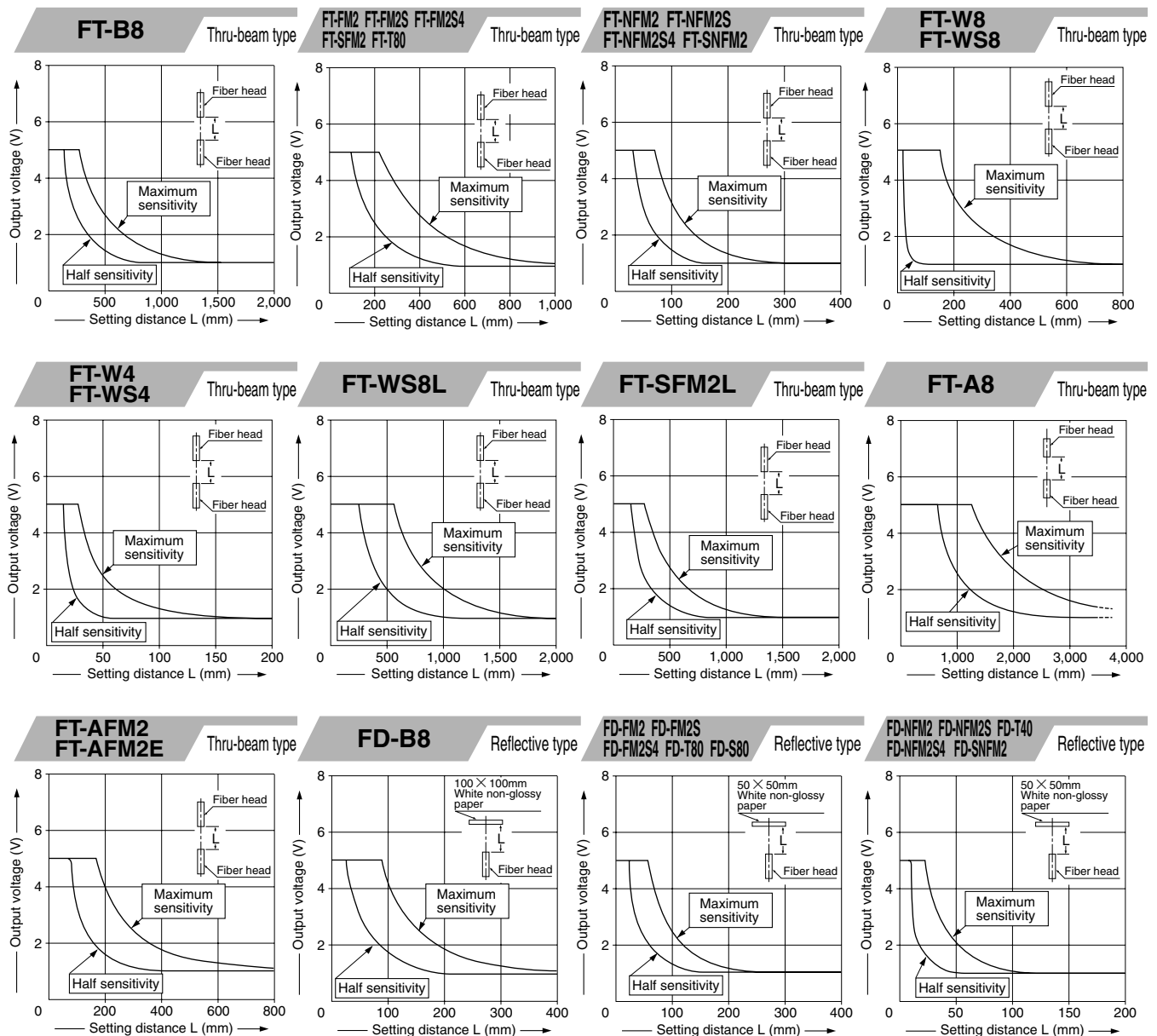

SENSING CHARACTERISTICS (TYPICAL)

Correlation between setting distance and output voltage

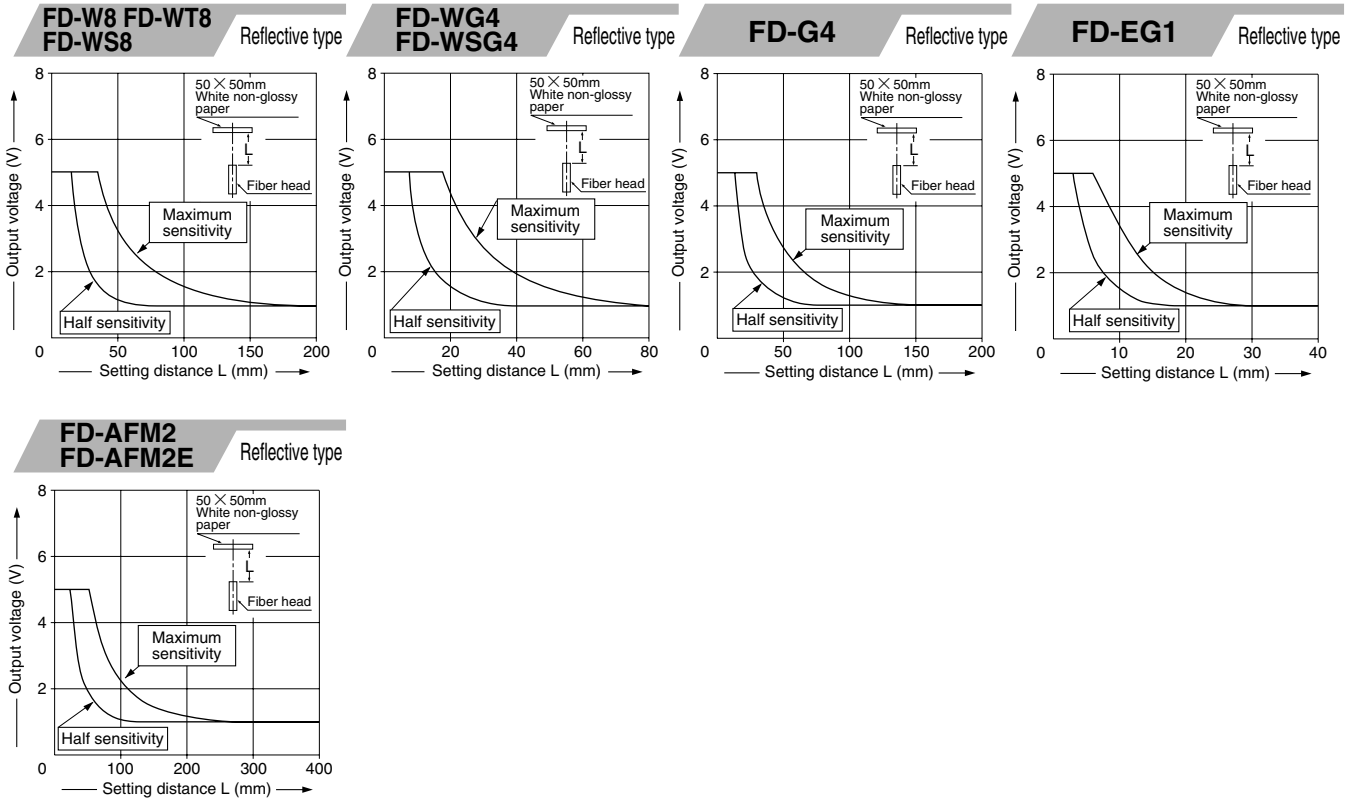

Correlation between setting distance and output voltage when using seal type slit masks

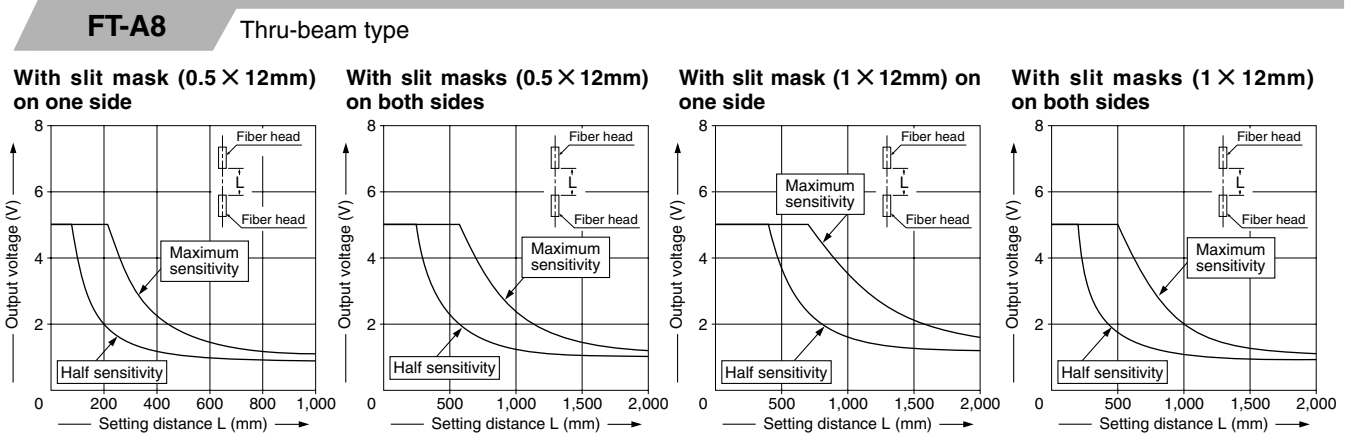

FX-11A

PRECAUTIONS FOR PROPER USE

Amplifier



This product is not a safety sensor. Its use is not intended or designed to protect life and prevent body injury or property damage from dangerous parts of machinery. It is a normal object detection sensor.

Mounting

How to mount the amplifier

- ① Fit the rear part of the amplifier on the attached amplifier mounting bracket (**MS-DIN-2**) or a 35mm width DIN rail.
- ② Press down the front part of the amplifier on the amplifier mounting bracket (**MS-DIN-2**) or DIN rail to fit it.

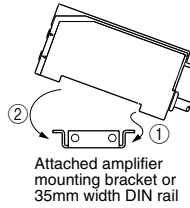

How to remove the amplifier

- ① Push the amplifier forward.
- ② Lift up the front part of the amplifier to remove it.

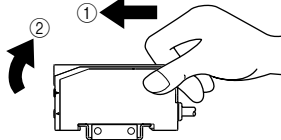

How to connect the fiber cables

- ① Unlock the fiber lock lever.
- ② Insert the fiber cables slowly into the inlets until they stop.
- ③ Lock the fiber lock lever in the original position.

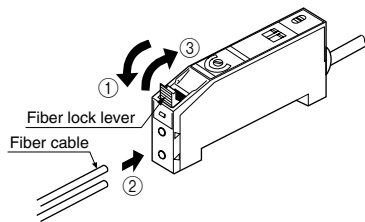

- Notes: 1) In case the fiber cables are not inserted to a position where they stop, the sensing range reduces.
 2) With the coaxial reflective type fiber, such as **FD-G4** or **FD-FM2**, insert the center fiber cable (single-core) into the beam-emitting inlet and the outer fiber cable (multi-core) into the beam-receiving inlet. If they are inserted in reverse, the sensing accuracy will deteriorate.

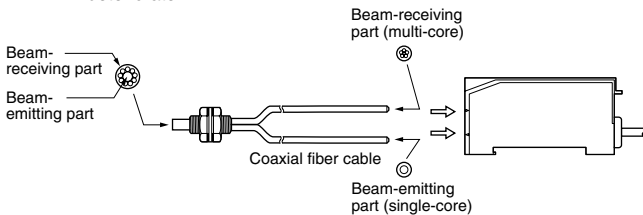

Interference prevention function

- Two sets of fibers can be mounted close together because an interference prevention function has been incorporated in **FX-11A**.
 The wiring and the setting of the interference prevention selection switch should be done as follows.

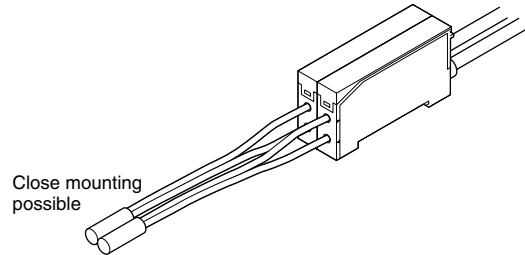

① Wiring

- Connect together the interference prevention wires and the 0V wires of the two **FX-11A** amplifiers, respectively.

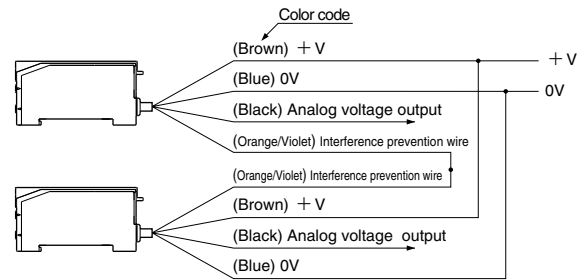

② Interference prevention selection switch

- Set the interference prevention selection switch to 'MAIN' for one amplifier and to 'SUB' for the other amplifier.
- ※ **In case interference function is not used**
- Make sure to set the interference prevention selection switch to 'MAIN'. If it is set to 'SUB', the sensor will not work.
- Insulate the interference prevention wire.

