

GL-18H/18HL

Square-shaped Long Range Inductive Proximity Sensor

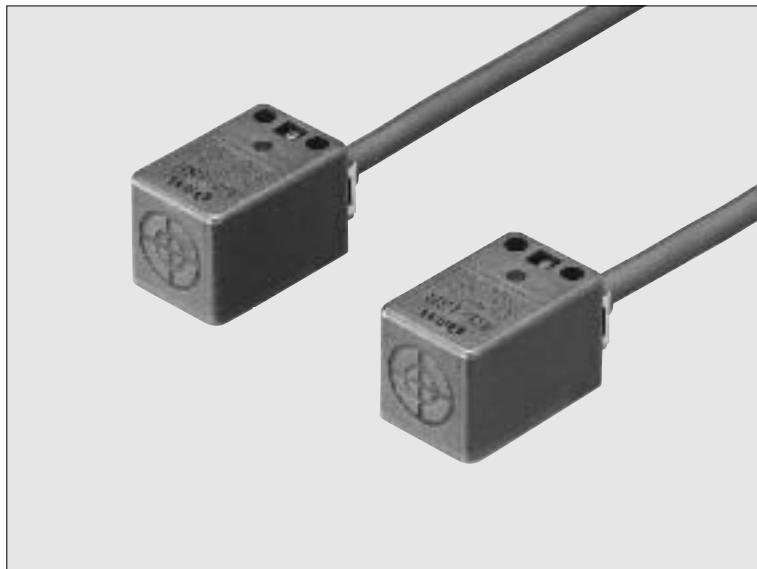

High Performance Sensing

CE Marked
Conforming to EMC Directive

Low Price

It provides high performance at a low price.

Different Frequency Type

Two sensors can be mounted closely because different frequency types are available.

(The long sensing range type, **GL-18HL(B)**, and its different frequency type, **GL-18HLI**, can be mounted 20mm away from each other.)

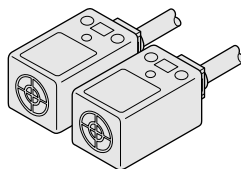

Long Sensing Range

GL-18HL□ offers a long sensing range of 12mm.
(**GL-18H□**: 5mm)

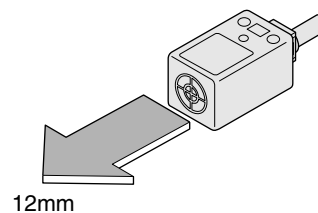

APPLICATIONS

Detecting over-run of moving table

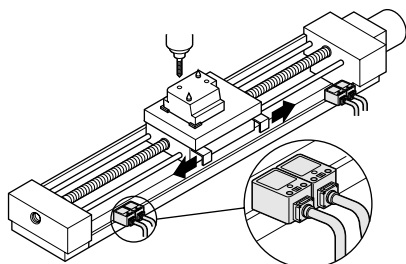

Positioning metal pallet

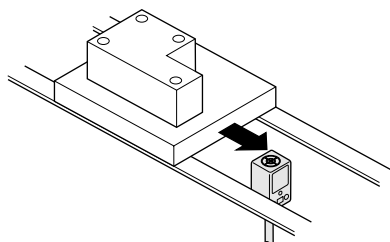

Detecting aluminum lid

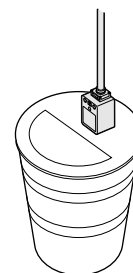

GL-18H/18HL

ORDER GUIDE

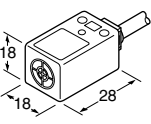
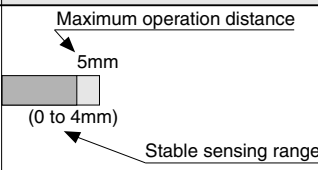
Type	Appearance (mm)	Sensing range (Note 1)	Model No. (Note 2)	Output operation	
Standard			GL-18H	Normally open	
			GL-18HI		
			GL-18HB	Normally closed	
Long sensing range				GL-18HL	Normally open
				GL-18HLI	
				GL-18HLB	Normally closed

Notes: 1) The maximum operation distance stands for the maximum distance for which the sensor can detect the standard sensing object.

The stable sensing range stands for the sensing range for which the sensor can stably detect the standard sensing object even if there is an ambient temperature drift and/or supply voltage fluctuation.

2) 'I' in the model No. indicates a different frequency type.

SPECIFICATIONS

Item	Type Model No.	Standard			Long sensing range		
		GL-18H	Different frequency GL-18HI	GL-18HB	GL-18HL	Different frequency GL-18HLI	GL-18HLB
Max. operation distance (Note)		5mm ± 10%			12mm ± 10%		
Stable sensing range (Note)		0 to 4mm			0 to 10mm		
Standard sensing object		Iron sheet 25 × 25 × 1mm			Iron sheet 40 × 40 × 1mm		
Hysteresis		15% or less of operation distance					
Supply voltage		10 to 30V DC Ripple P-P 10% or less					
Current consumption		10mA or less					
Output		NPN open-collector transistor <ul style="list-style-type: none"> • Maximum sink current: 100mA • Applied voltage: 30V DC or less (between output and 0V) • Residual voltage: 1.5V or less (at 100mA sink current) 0.4V or less (at 16mA sink current) 					
Utilization category		DC-12 or DC-13					
Output operation		Normally open		Normally closed		Normally open	Normally closed
Max. response frequency		1kHz			500Hz		
Operation indicator		Red LED (lights up when the output is ON)					
Environmental resistance	Pollution degree	3 (Industrial environment)					
	Protection	IP67 (IEC), IP67g (JEM)					
	Ambient temperature	- 25 to + 70°C, Storage: - 25 to + 70°C					
	Ambient humidity	45 to 85% RH, Storage: 45 to 85% RH					
	EMC	Emission: EN50081-2, Immunity: EN50082-2					
	Voltage withstandability	1,000V AC for one min. between all supply terminals connected together and enclosure					
	Insulation resistance	50MΩ, or more, with 250V DC megger between all supply terminals connected together and enclosure					
	Vibration resistance	10 to 55Hz frequency, 1.5mm amplitude in X, Y and Z directions for two hours each					
Shock resistance	1,000m/s ² acceleration (100G approx.) in X, Y and Z directions for three times each						
Sensing range variation	Temperature characteristics	Over ambient temperature range - 25 to + 70°C: within ± 10% of sensing range at 20°C					
	Voltage characteristics	Within ± 2% for ± 10% fluctuation of the supply voltage					
Material		Enclosure: Polyalylate					
Cable		0.3mm ² 3-core oil resistant cabtyre cable, 1m long					
Cable extension		Extension up to total 100m is possible with 0.3mm ² , or more, cable.					
Weight		45g approx.					
Accessory						MS-GL18HL (Sensor mounting bracket): 1 set	

Note: The maximum operation distance stands for the maximum distance for which the sensor can detect the standard sensing object.

The stable sensing range stands for the sensing range for which the sensor can stably detect the standard sensing object even if there is an ambient temperature drift and/or supply voltage fluctuation.

GL-18H/18HL

I/O CIRCUIT AND WIRING DIAGRAMS

GL-18H□
GL-18HL□

I/O circuit diagram

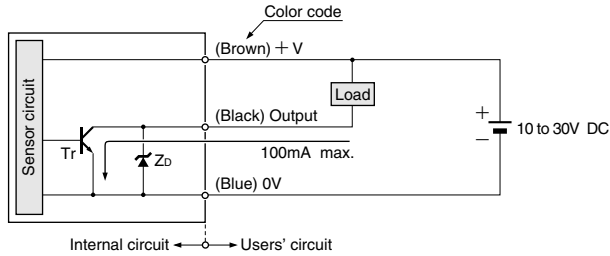

Symbols ... Z_d: Surge absorption zener diode
Tr: NPN output transistor

Wiring diagram

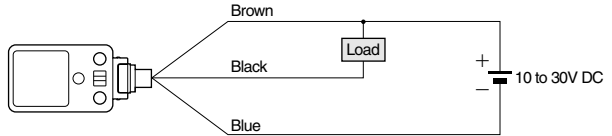

SENSING CHARACTERISTICS (TYPICAL)

GL-18H□

Sensing field

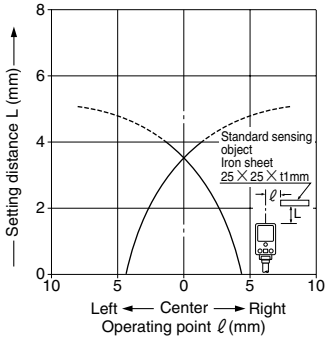

Correlation between sensing object size and sensing range

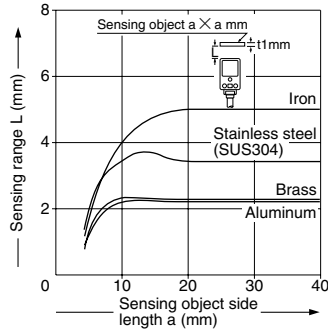

As the sensing object size becomes smaller than the standard size (iron sheet 25 × 25 × 1mm), the sensing range shortens as shown in the left figure.

GL-18HL□

Sensing field

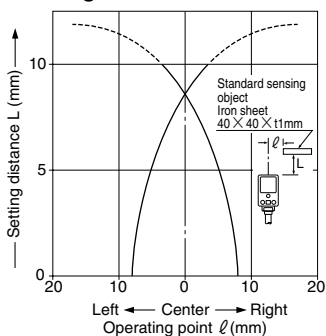

Correlation between sensing object size and sensing range

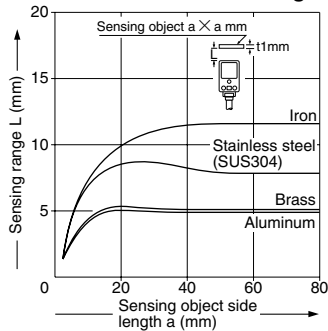

As the sensing object size becomes smaller than the standard size (iron sheet 40 × 40 × 1mm), the sensing range shortens as shown in the left figure.

GL-18H/18HL

PRECAUTIONS FOR PROPER USE



This product is not a safety sensor. Its use is not intended or designed to protect life and prevent body injury or property damage from dangerous parts of machinery. It is a normal object detection sensor.

Mounting

- The tightening torque should be 0.5N·m or less.
- To mount the sensor with a nut, the thru-hole diameter should be $\phi 3.4\text{mm}$.
- Screws, nuts or washers 10.5mm are not supplied. Please arrange them separately.

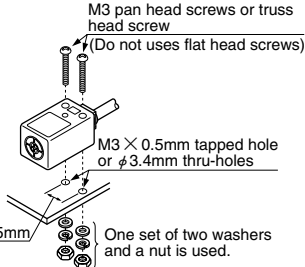

Influence of surrounding metal

- When there is a metal near the sensor, keep the minimum separation distance specified below.

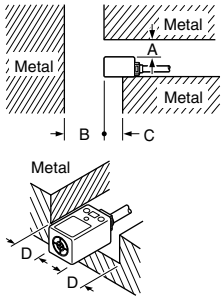

	GL-18H□	GL-18HL□
A	5mm	25mm
B	20mm	60mm
C	0mm	20mm (Note)
D	5mm	30mm

Note: When the GL-18HL□ is mounted on an insulator, or seated on the attached aluminum mounting bracket, the distance 'C' can be zero.

Mutual interference prevention

- When two or more sensors are installed in parallel or face to face, keep the minimum separation distance specified below to avoid mutual interference.

	GL-18H□		GL-18HL□	
	Between 'I' type and non 'I' type	Between two 'I' types or two non 'I' types	Between 'I' type and non 'I' type	Between two 'I' types or two non 'I' types
E	0mm (Note 2)	40mm	20mm (Note 2)	130mm
F	20mm	70mm	40mm	200mm

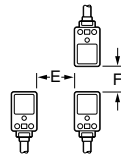

Notes: 1) 'I' in the model No. specifies the different frequency type.

2) Close mounting is possible for up to two sensors.

When mounting three sensors or more, at an equal spacing, in a row, the minimum value of dimension E should be 11mm.

DIMENSIONS (Unit: mm)

GL-18H□ GL-18HL□ Sensor

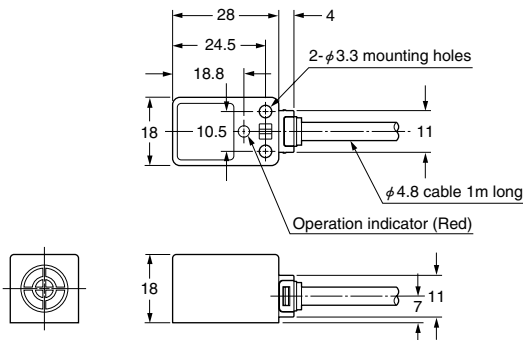

MS-GL18HL Sensor mounting bracket for GL-18HL□ (Accessory)

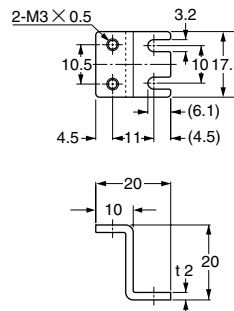

Material: Aluminum
Two M3 pan head screws are attached.

GL-6 SERIES

Miniature Inductive Proximity Sensor

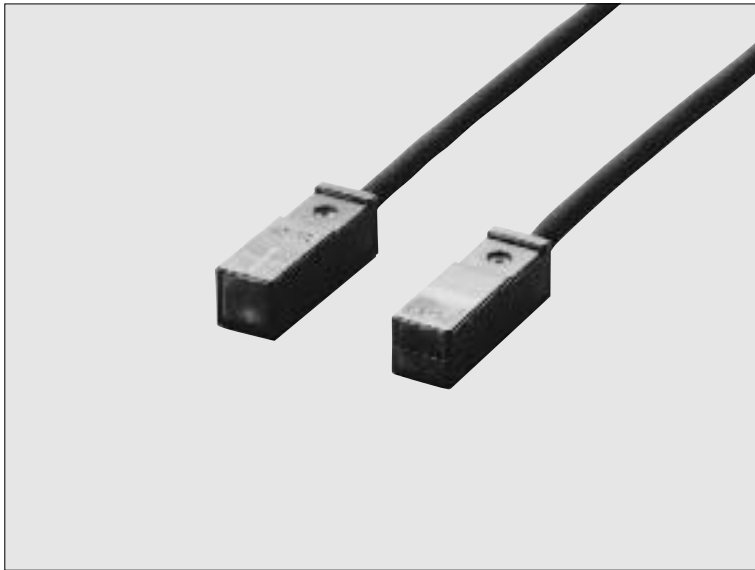

High Performance in Surprisingly Small Body

CE Marked
Conforming to EMC Directive

Extremely Small

Mountable in a tight space as the sensor is just $6 \times 6 \times 19$ mm in volume. It is optimum for use as a component in an equipment.

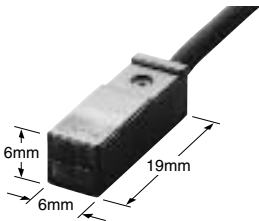

Low Price

The **GL-6** is available at a surprisingly low price.

Operation Indicator

Despite its compactness, **GL-6** incorporates an operation indicator for operation check.

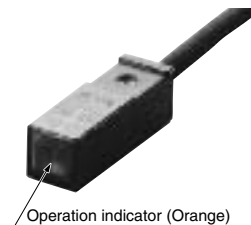

Close Mounting

Two sensors can be mounted closely because different frequency type are available.

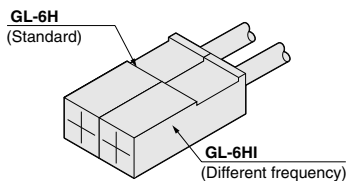

APPLICATIONS

Observing table over-run

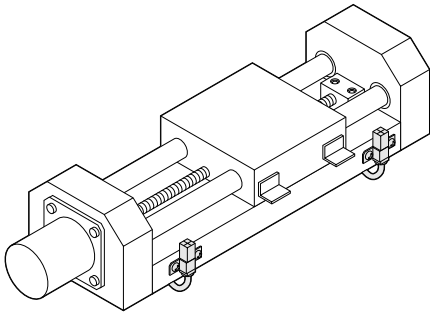

Sensing cam positions

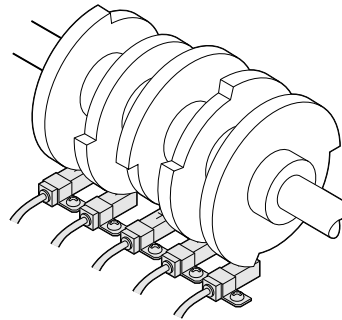

ORDER GUIDE

Type	Appearance (mm)	Sensing range (Note 1)	Model No. (Note 2)	Output operation
Front sensing			GL-6F	Normally open
			GL-6FI	
			GL-6FB	Normally closed
			GL-6FIB	
Top sensing			GL-6H	Normally open
			GL-6HI	Normally closed
			GL-6HB	
			GL-6HIB	

Notes: 1) The maximum operation distance stands for the maximum distance for which the sensor can detect the standard sensing object.

The stable sensing range stands for the sensing range for which the sensor can stably detect the standard sensing object even if there is an ambient temperature drift and/or supply voltage fluctuation.

2) 'I' in the model No. indicates a different frequency type.

OPTION

Designation	Model No.	Description
Sensor mounting bracket	MS-GL6-2	The brackets are useful to mount sensors side by side.

Sensor mounting bracket

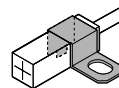

Screw, nut or washer are not supplied.

GL-6

SPECIFICATIONS

Type		Miniature							
		Front sensing				Top sensing			
Item	Model No.	Different frequency		Different frequency		Different frequency		Different frequency	
		GL-6F	GL-6FI	GL-6FB	GL-6FIB	GL-6H	GL-6HI	GL-6HB	GL-6HIB
Max. operation distance (Note)		1.6mm ± 15%							
Stable sensing range (Note)		0 to 1.2mm							
Standard sensing object		Iron sheet 12 × 12 × 1mm							
Hysteresis		15% or less of operation distance							
Supply voltage		12 to 24V DC $\pm 10\%$ / -15% Ripple P-P10% or less							
Current consumption		15mA or less							
Output		NPN open-collector transistor • Maximum sink current: 50mA • Applied voltage: 30V DC or less (between output and 0V) • Residual voltage: 1V or less (at 50mA sink current) 0.4V or less (at 16mA sink current)							
Utilization category		DC-12 or DC-13							
Output operation		Normally open	Normally closed	Normally open	Normally open	Normally open	Normally open	Normally closed	Normally closed
Max. response frequency		400Hz							
Operation indicator		Orange LED (lights up when the output is ON)							
Environmental resistance	Pollution degree	3 (Industrial environment)							
	Protection	IP67 (IEC), IP67g (JEM)							
	Ambient temperature	- 10 to + 55°C, Storage: - 30 to + 80°C							
	Ambient humidity	45 to 85% RH, Storage: 35 to 95% RH							
	EMC	Emission: EN50081-2, Immunity: EN50082-2							
	Voltage withstandability	1,000V AC for one min. between all supply terminals connected together and enclosure							
	Insulation resistance	50MΩ, or more, with 250V DC megger between all supply terminals connected together and enclosure							
	Vibration resistance	10 to 55Hz frequency, 1.5mm amplitude in X, Y and Z directions for two hours each							
	Shock resistance	1,000m/s ² acceleration (100G approx.) in X, Y and Z directions for three times each							
Sensing range variation	Temperature characteristics	Over ambient temperature range - 10 to + 55°C: within ± 10% of sensing range at 20°C							
	Voltage characteristics	Within ± 2% for ± 10% fluctuation of the supply voltage							
Material		Enclosure: Polyallylate							
Cable		0.08mm ² 3-core oil, heat and cold resistant cabtyre cable, 1m long							
Cable extension		Extension up to total 100m is possible with 0.3mm ² , or more, cable.							
Weight		10g approx.							
Accessory		MS-GL6-1 (Sensor mounting bracket): 1 No.							

Note: The maximum operation distance stands for the maximum distance for which the sensor can detect the standard sensing object.
 The stable sensing range stands for the sensing range for which the sensor can stably detect the standard sensing object even if there is an ambient temperature drift and/or supply voltage fluctuation.

I/O CIRCUIT AND WIRING DIAGRAMS

I/O circuit diagram

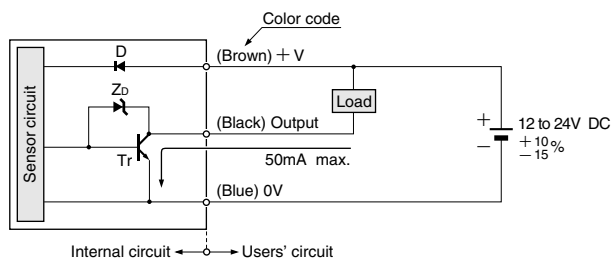

Symbols ... D: Reverse supply polarity protection diode
 Zp: Surge absorption zener diode
 Tr: NPN output transistor

Wiring diagram

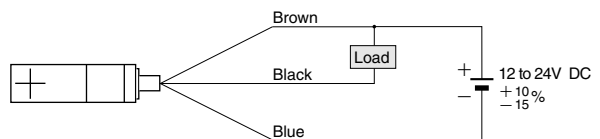

SENSING CHARACTERISTICS (TYPICAL)

Sensing field

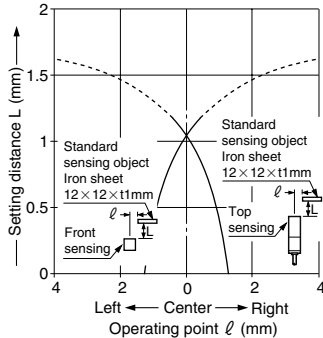

Correlation between sensing object size and sensing range

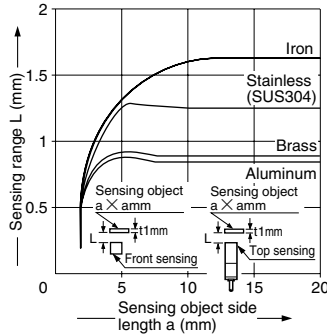

As the sensing object size becomes smaller than the standard size (iron sheet 12×12×1mm), the sensing range shortens as shown in the left figure.

PRECAUTIONS FOR PROPER USE



This product is not a safety sensor. Its use is not intended or designed to protect life and prevent body injury or property damage from dangerous parts of machinery. It is a normal object detection sensor.

Mounting

• Mount the sensor with the attached sensor mounting bracket **MS-GL6-1** or the optional sensor mounting bracket **MS-GL6-2**.

• Screws, nuts or washers are not supplied. Please arrange them separately.

• To mount the sensor with a nut, the hole diameter should be $\phi 3.4$ mm.

Influence of surrounding metal

• When there is a metal near the sensor, keep the minimum separation distance specified below.

GL-6F□ (Unit: mm)

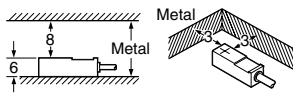

GL-6H□ (Unit: mm)

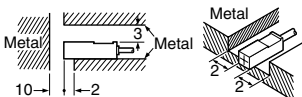

Wiring

• The output is not incorporated with a short-circuit protection circuit. Do not connect it directly to a power supply or a capacitive load.

DIMENSIONS (Unit: mm)

GL-6F□ Sensor

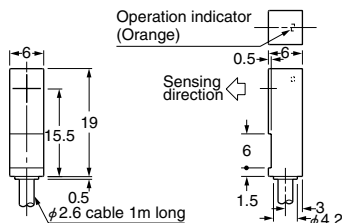

GL-6H□ Sensor

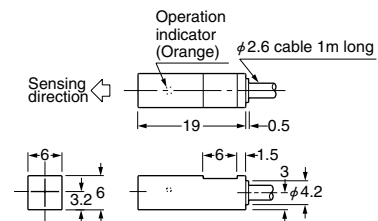

MS-GL6-1 Sensor mounting bracket (Accessory)

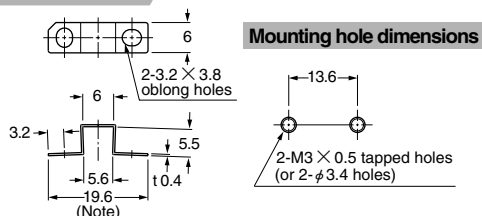

Note: 20mm with the sensor fitted.

MS-GL6-2 Sensor mounting bracket (Optional)

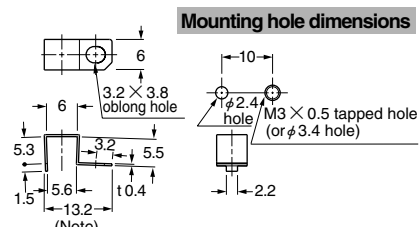

Note: 13.4mm with the sensor fitted.

Mutual interference

• When two or more sensors are installed in parallel or face to face, keep the minimum separation distance specified below to avoid mutual interference.

	GL-6F□, GL-6H□		GL-6F□	GL-6H□
	Between 'I' type and non 'I' type	Between two 'I' types or two non 'I' types	A	B
A	0mm (Note 2)	13mm		
B	15mm	25mm		

Notes: 1) 'I' in the model No. specifies the different frequency type.

2) Close mounting is possible for up to two sensors. When mounting three sensors or more, at an equal spacing, in a row, the minimum value of dimension A should be 3.5mm.

Sensing range

• The sensing range is specified for the standard sensing object (iron sheet 12×12×1mm). With a non-ferrous metal, the sensing range is obtained by multiplying with the correction coefficient specified on the right. Further, the sensing range also changes if the sensing object is smaller than the standard sensing object (iron sheet 12×12×1mm) or if the sensing object is plated.

Correction coefficient

Model No.	GL-6F□ GL-6H□
Metal	
Iron	1
Stainless steel (SUS304)	0.76 approx.
Brass	0.55 approx.
Aluminum	0.52 approx.

Others

• Do not use during the initial transient time (50ms) after the power supply is switched on.

GL-8U SERIES

Low Price DC 2-wire & Compact Inductive Proximity Sensor



**Energy-saving
Wire-saving**

CE Marked
Conforming to EMC Directive

Low Price

The **GL-8U** series satisfies the need for a low price inductive proximity sensor. It is recommended to large volume users for cost reduction.

The **GL-8U** series is available in units of ten sensors.

Current Consumption Reduced by 95% Approx.

The current consumption is 0.8mA or less, which realizes an energy-saving of 95% approx., as compared to a DC 3-wire sensor.

Being an 'energy-saving' sensor, it is environment friendly.

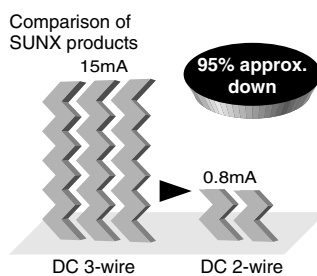

Wiring Operations Reduced by 30% approx.

The DC 2-wire sensor reduces wiring operations by 30% approx. as compared to the DC 3-wire sensor. Moreover, chances of miswiring are also decreased.

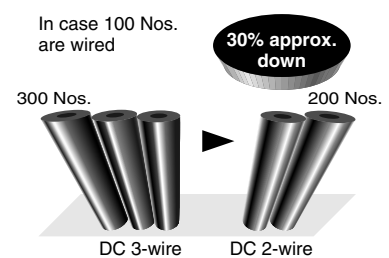

Wide Variety

A wide variety of 8 types, front sensing type/top sensing type, normally open type/normally closed type, as well as, different frequency type which allows close mounting of sensors, is available.

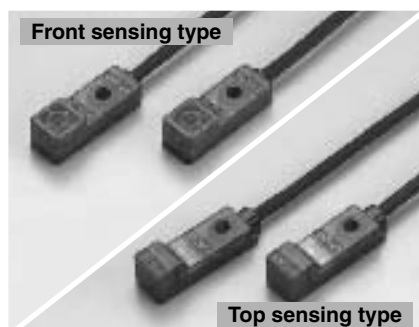

Equipped with Operation Indicator

The **GL-8U** series is equipped with an operation indicator (orange) for operation confirmation.

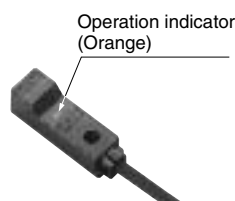

Waterproof

Since the sensor has IP67 protection, it can withstand water splashes.



APPLICATIONS

Detecting table over-run

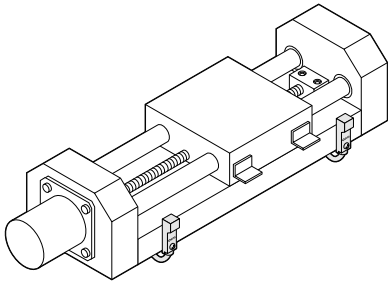

Detecting cam position

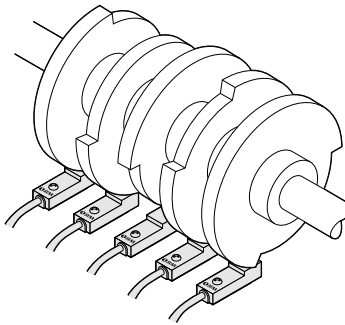

ORDER GUIDE

Type	Appearance (mm)	Sensing range (Note 1)	Model No. (Note 2)	Output	Output operation
Front sensing		<p>Maximum operation distance 2.5mm</p>	GL-8FU × 10	Non-contact DC 2-wire type	Normally open
			GL-8FUI × 10		Normally closed
			GL-8FUB × 10		Normally open
			GL-8FUIB × 10		
Top sensing		<p>(0 to 1.8mm) Stable sensing range</p>	GL-8HU × 10		Normally open
			GL-8HUI × 10		Normally closed
			GL-8HUB × 10		
			GL-8HUIB × 10		

Notes: 1) The maximum operation distance stands for the maximum distance for which the sensor can detect the standard sensing object. The stable sensing range stands for the sensing range for which the sensor can stably detect the standard sensing object even if there is an ambient temperature drift and/or supply voltage fluctuation.

2) 'I' in the model No. indicates a different frequency type.

NOTE: Low price DC 2-wire & compact inductive proximity sensors (GL-8U series) are available in units of ten.

OPTION

Designation	Model No.
Sensor mounting bracket	MS-GL8 × 10

NOTE: Sensor mounting bracket (MS-GL8 × 10) is available in units of ten.

Sensor mounting bracket

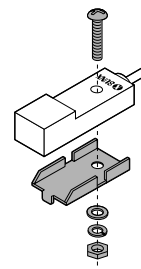

1 No. each of M3 (length 12mm) truss head screw, nut, spring washer and plain washer is attached.

GL-8U

SPECIFICATIONS

Item	Type Model No.	Front sensing				Top sensing			
		Different frequency	Different frequency	Different frequency	Different frequency	Different frequency	Different frequency	Different frequency	
Max. operation distance (Note 1)		2.5mm ± 20%							
Stable sensing range (Note 1)		0 to 1.8mm							
Standard sensing object		Iron sheet 15 × 15 × 1mm							
Hysteresis		20% or less of operation distance							
Supply voltage		12 to 24V DC ± 10%							
Current consumption (Note 2)		0.8mA or less							
Output		Non-contact DC 2-wire type • Load current: 3 to 70mA (Note 3) • Residual voltage: 3V or less (Note 4)							
Utilization category		DC-12 or DC-13							
Output operation		Normally open	Normally closed		Normally open		Normally closed		
Short-circuit protection		Incorporated							
Max. response frequency		1kHz							
Operation indicator		Orange LED (lights up when the output is ON)							
Environmental resistance	Pollution degree	3 (Industrial environment)							
	Protection	IP67 (IEC)							
	Ambient temperature	− 25 to + 70°C, Storage: − 30 to + 80°C							
	Ambient humidity	35 to 95% RH, Storage: 35 to 95% RH							
	EMC	Emission: EN50081-2, Immunity: EN50082-2							
	Voltage withstandability	1,000V AC for one min. between all supply terminals connected together and enclosure							
	Insulation resistance	50MΩ, or more, with 250V DC megger between all supply terminals connected together and enclosure							
	Vibration resistance	10 to 55Hz frequency, 1.5mm amplitude in X, Y and Z directions for two hours each							
	Shock resistance	1,000m/s ² acceleration (100G approx.) in X, Y and Z directions for three times each							
Sensing range variation	Temperature characteristics	Over ambient temperature range − 25 to + 70°C: within $\pm \frac{15}{10}$ % of sensing range at 20°C							
	Voltage characteristics	Within ± 2% for ± 10% fluctuation of the supply voltage							
Material		Enclosure: Polyallylate							
Cable		0.15mm ² 2-core cabtyre cable, 1m long							
Cable extension		Extension up to total 50m is possible with 0.3mm ² , or more, cable.							
Weight		12g approx.							

- Notes: 1) The maximum operation distance stands for the maximum distance for which the sensor can detect the standard sensing object. The stable sensing range stands for the sensing range for which the sensor can stably detect the standard sensing object even if there is an ambient temperature drift and/or supply voltage fluctuation.
 2) It is the leakage current when the output is in the OFF state.
 3) The maximum load current varies with the ambient temperature. Refer to 'I/O CIRCUIT AND WIRING DIAGRAMS' for more details.
 4) When the cable is extended, the residual voltage becomes larger according to the resistance of the cable.

I/O CIRCUIT AND WIRING DIAGRAMS

I/O circuit diagram

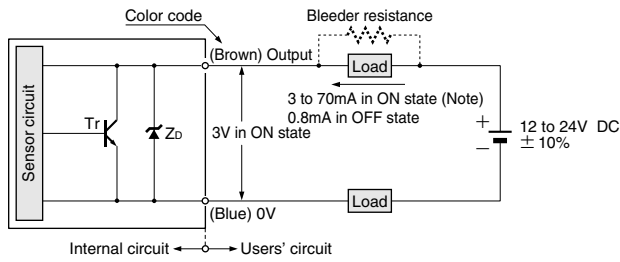

Symbols ... Z_D: Surge absorption zener diode
Tr: NPN output transistor

Note: The maximum load current varies depending on the ambient temperature.

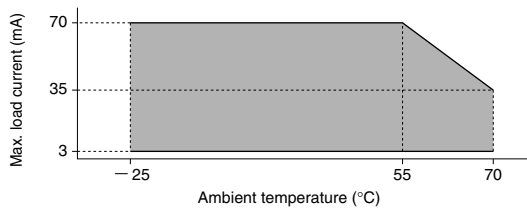

Wiring diagram

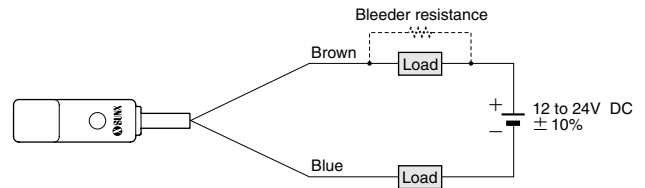

Conditions for the load

- 1) The load should not be actuated by the leakage current (0.8mA) in the OFF state.
- 2) The load should be actuated by (supply voltage - 3V) in the ON state.
- 3) The current in the ON state should be between 3 to 70mA DC.
(In case the current is less than 3mA, connect a bleeder resistance in parallel to the load so that a current of 3mA, or more, flows.)

SENSING CHARACTERISTICS (TYPICAL)

Sensing field

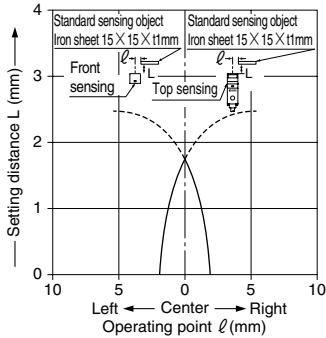

Correlation between sensing object size and sensing range

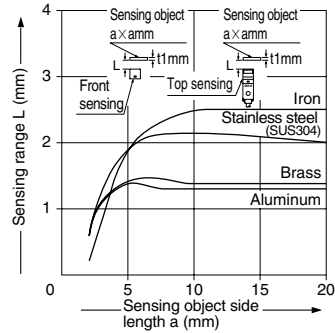

As the sensing object size becomes smaller than the standard size (iron sheet 15 × 15 × 1mm), the sensing range shortens as shown in the left figure.

GL-8U

PRECAUTIONS FOR PROPER USE



This product is not a safety sensor. Its use is not intended or designed to protect life and prevent body injury or property damage from dangerous parts of machinery. It is a normal object detection sensor.

Mounting

- Make sure to mount with an M3 (length 12mm) truss head screw with a tightening torque of 0.5 N·m or less.

(Do not use a flat head screw or a pan head screw.)

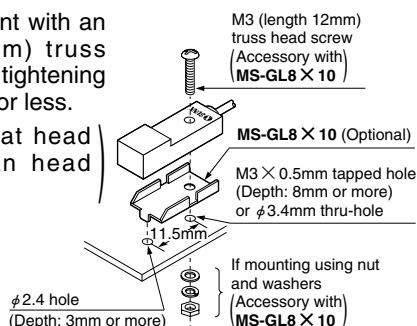

Influence of surrounding metal

- When there is a metal near the sensor, keep the minimum separation distance specified below.

GL-8FU□ × 10

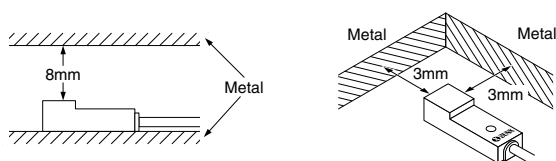

GL-8HU□ × 10

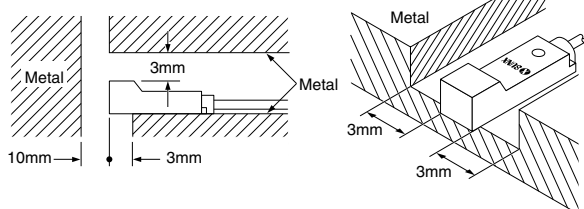

Mutual interference prevention

- When two or more sensors are installed in parallel or face to face, keep the minimum separation distance specified below to avoid mutual interference.

GL-8FU□ × 10

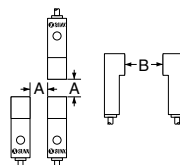

GL-8HU□ × 10

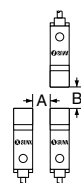

		A	B
GL-8FU type	Between 'I' type and non 'I' type	0mm (Note 2)	15mm
	Between two 'I' types or two non 'I' types	20mm	40mm
GL-8HU type	Between 'I' type and non 'I' type	0mm (Note 2)	15mm
	Between two 'I' types or two non 'I' types	25mm	40mm

Notes: 1) 'I' in the model No. specifies the different frequency type.

- 2) Close mounting is possible for up to two sensors. When mounting three sensors or more, at an equal spacing, in a row, the minimum value of dimension A should be as given below.

GL-8FU type: 6mm

GL-8HU type: 8.5mm

Sensing range

- The sensing range is specified for the standard sensing object (iron sheet 15×15×t1mm).

With a non-ferrous metal, the sensing range is obtained by multiplying with the correction coefficient specified on the right.

Further, the sensing range also changes if the sensing object is smaller than the standard sensing object (iron sheet 15×15×t1mm) or if the sensing object is plated.

Correction coefficient

Model No.	GL-8FU□ × 10 GL-8HU□ × 10
Metal	
Iron sheet	1
Stainless Steel (SUS304)	0.80 approx.
Brass	0.54 approx.
Aluminum	0.52 approx.

Others

- Do not use during the initial transient time (50ms) after the power supply is switched on.

DIMENSIONS (Unit: mm)

GL-8FU□ × 10 Sensor

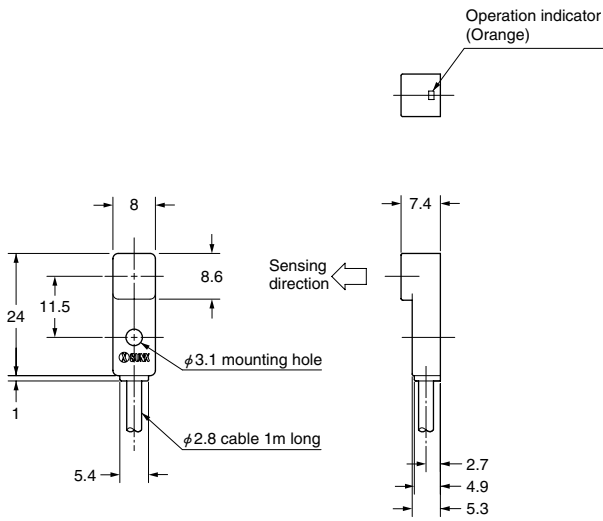

GL-8HU□ × 10 Sensor

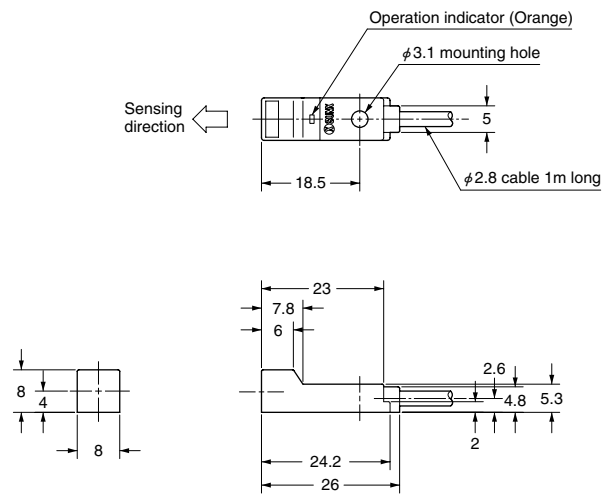

MS-GL8 × 10 Sensor mounting bracket (Optional)

Mounting hole dimensions

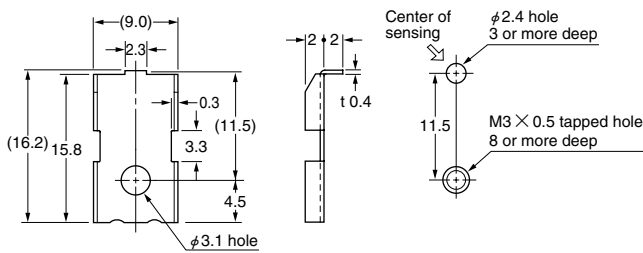

Material: Stainless steel (SUS304)

1 No. each of M3 (length 12mm) truss head screw, nut, spring washer and plain washer is attached.

GL-N12 SERIES

Square-shaped Inductive Proximity Sensor

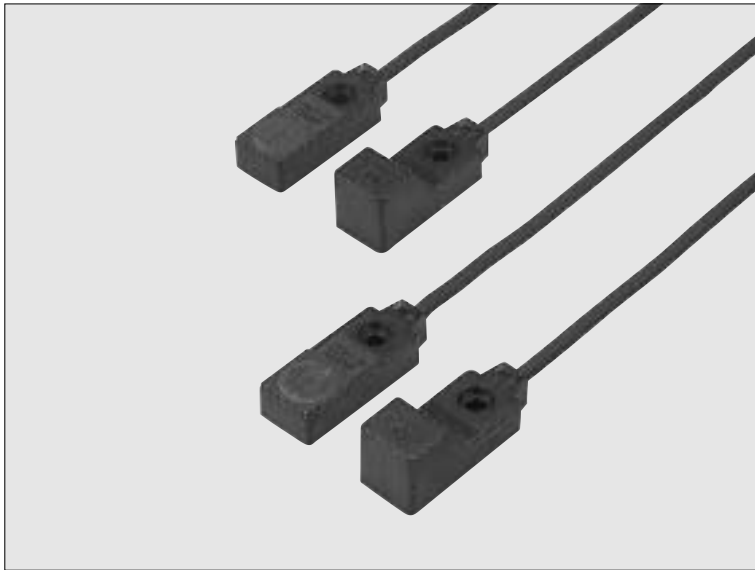

Wide Variety with Total Cost Reduction

CE Marked
Conforming to EMC Directive

Exclusive Mounting Bracket is Needless

The **GL-N12** series can be reliably fixed even without an exclusive mounting bracket as a boss is provided on the bottom face of the sensor to prevent rotation.

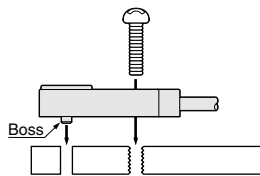

Low Price

The **GL-N12** series is recommended to large volume users for cost reduction.

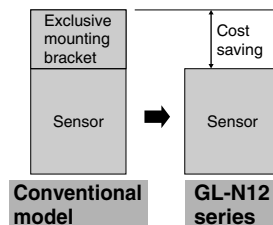

Cost saving is achieved as the exclusive mounting bracket is not required.

The **GL-N12** series is available in units of ten sensors.

Wide Variation

A wide variety of 16 types, front sensing type/top sensing type, normally open type/normally closed type, as well as, different frequency type, PNP output type, etc., is available.

You can choose from the vastly increased variety to suit your application.

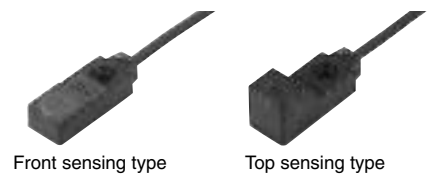

Long Sensing Range

It achieves a sensing range of 4mm with a 12mm square-size sensing part. It can reliably detect an object even if its position varies slightly.

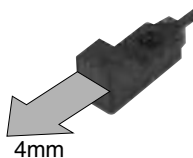

Waterproof

Since the sensor has IP67 protection, it can withstand water splashes.



APPLICATIONS

Confirming shutting/opening of door

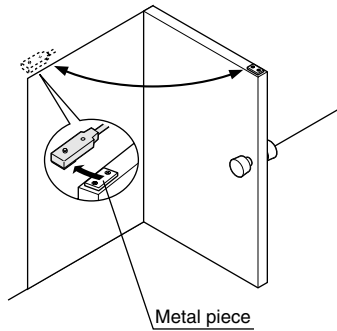

Detecting rolling coins

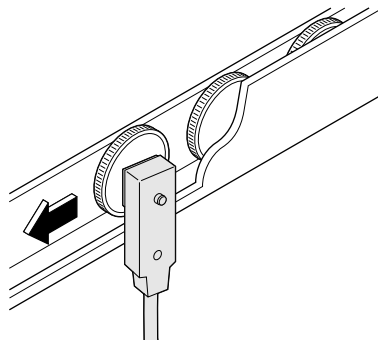

Detecting metal parts on a feeder

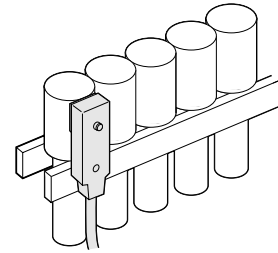

ORDER GUIDE

Type	Appearance (mm)	Sensing range (Note 1)	Model No. (Note 2)	Output	Output operation	
Boss type			GL-N12F X 10	NPN open-collector transistor	Normally open	
			GL-N12FI X 10		Normally closed	
			GL-N12FB X 10		PNP open-collector transistor	Normally open
			GL-N12FIB X 10			Normally closed
			GL-N12F-P X 10	PNP open-collector transistor	Normally open	
			GL-N12FI-P X 10		Normally closed	
Top sensing			GL-N12H X 10	NPN open-collector transistor	Normally open	
			GL-N12HI X 10		Normally closed	
			GL-N12HB X 10		PNP open-collector transistor	Normally open
			GL-N12HIB X 10			Normally closed
			GL-N12H-P X 10	PNP open-collector transistor	Normally open	
			GL-N12HB-P X 10		Normally closed	
			GL-N12HIB-P X 10			

Notes: 1) The maximum operation distance stands for the maximum distance for which the sensor can detect the standard sensing object.
The stable sensing range stands for the sensing range for which the sensor can stably detect the standard sensing object even if there is an ambient temperature drift and/or supply voltage fluctuation.
2) 'I' in the model No. indicates a different frequency type (custom-order product).

NOTE: Low price square-shaped inductive proximity sensors (GL-N12 series) are available in units of ten.

Without boss type (Front sensing type, NPN output type and normally open type only) Units of ten

The without boss type is also available. (Standard: boss type)

Model No.: GL-12F X 10 (front sensing type)

MS-GL12 X 10 (sensor mounting bracket)

GL-N12

SPECIFICATIONS

Item	Model No.	Type	Boss type (Note 1)								
			NPN output				PNP output				
			Front sensing		Top sensing		Front sensing		Top sensing		
			Different frequency		Different frequency		Different frequency		Different frequency		
		Normally open	GL-N12FX10	GL-N12FI X10	GL-N12HX10	GL-N12HI X10	GL-N12F-P X10	GL-N12FI-P X10	GL-N12H-PX10	GL-N12HI-PX10	
		Normally closed	GL-N12FBX10	GL-N12FIB X10	GL-N12HB X10	GL-N12HIB X10	GL-N12FB-P X10	GL-N12FIB-PX10	GL-N12HB-PX10	GL-N12HIB-PX10	
Max. operation distance (Note 2)		4 ± 0.5mm									
Stable sensing range (Note 2)		0 to 3mm									
Standard sensing object		Iron sheet 20 × 20 × 1mm									
Hysteresis		20% or less of operation distance									
Supply voltage		12 to 24V DC ± 10% Ripple P-P 10% or less									
Current consumption		10mA or less				15mA or less					
Output		NPN open-collector transistor <ul style="list-style-type: none"> • Maximum sink current: 100mA • Applied voltage: 30V DC or less (between output and 0V) • Residual voltage: 1V or less (at 100mA sink current) 0.4V or less (at 16mA sink current) 				PNP open-collector transistor <ul style="list-style-type: none"> • Maximum source current: 100mA • Applied voltage: 30V DC or less (between output and +V) • Residual voltage: 1V or less (at 100mA source current) 0.4V or less (at 16mA source current) 					
Utilization category		DC-12 or DC-13									
Max. response frequency		1.3kHz									
Operation indicator		Orange LED (lights up when the output is ON)									
Environmental resistance	Pollution degree		3 (Industrial environment)								
	Protection		IP67 (IEC)								
	Ambient temperature		- 10 to + 55°C, Storage: - 25 to + 70°C								
	Ambient humidity		45 to 85% RH, Storage: 35 to 95% RH								
	EMC		Emission: EN50081-2, Immunity: EN50082-2								
	Voltage withstandability		1,000V AC for one min. between all supply terminals connected together and enclosure								
	Insulation resistance		50MΩ, or more, with 250V DC megger between all supply terminals connected together and enclosure								
	Shock resistance		10 to 55Hz frequency, 1.5mm amplitude in X, Y and Z directions for two hours each								
Sensing range variation	Temperature characteristics		Over ambient temperature range - 10 to + 55°C: within $\pm 15\%$ of sensing range at 20°C								
	Voltage characteristics		Within ± 2% for ± 10% fluctuation of the supply voltage								
Material		Enclosure: Polyalylate									
Cable		0.18mm ² 3-core cabtyre cable, 1m long									
Cable extension		Extension up to total 100m is possible with 0.3mm ² , or more, cable.									
Weight		20g approx.									

Notes: 1) The without boss type is also available.

The specifications are the same as for the boss type.

2) The maximum operation distance stands for the maximum distance for which the sensor can detect the standard sensing object.

The stable sensing range stands for the sensing range for which the sensor can stably detect the standard sensing object even if there is an ambient temperature drift and/or supply voltage fluctuation.

I/O CIRCUIT AND WIRING DIAGRAMS

NPN output type

I/O circuit diagram

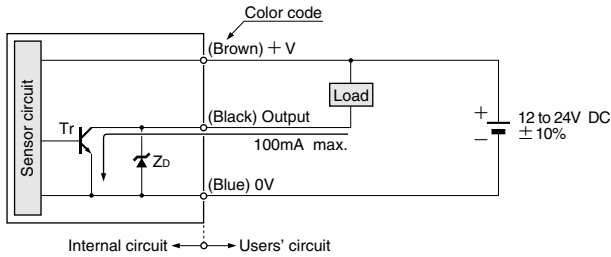

Symbols ... Zd: Surge absorption zener diode
Tr: NPN output transistor

Wiring diagram

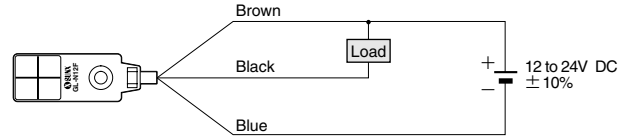

PNP output type

I/O circuit diagram

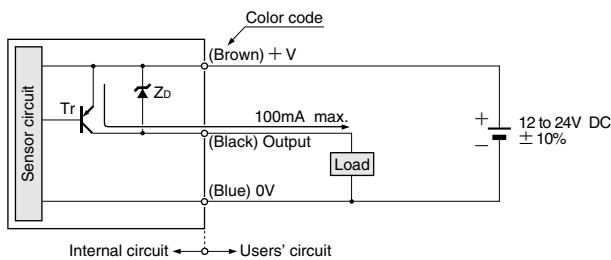

Symbols ... Zd: Surge absorption zener diode
Tr: PNP output transistor

Wiring diagram

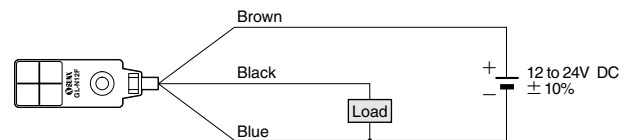

SENSING CHARACTERISTICS (TYPICAL)

Sensing field

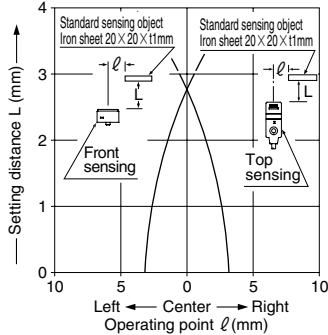

Correlation between sensing object size and sensing range

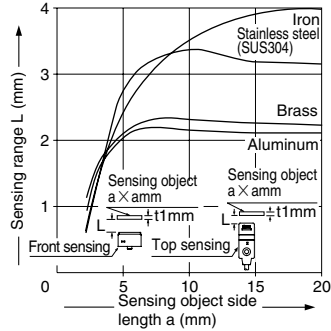

As the sensing object size becomes smaller than the standard size (iron sheet 20×20×1mm), the sensing range shortens as shown in the left figure.

GL-N12

PRECAUTIONS FOR PROPER USE



This product is not a safety sensor. Its use is not intended or designed to protect life and prevent body injury or property damage from dangerous parts of machinery. It is a normal object detection sensor.

Mounting

- The tightening torque should be 0.5N·m or less.
- To mount the sensor with a nut, the mounting hole diameter should be $\phi 3.4$ mm. Further, the hole in which the boss is inserted should be $\phi 2.5$ mm and 3mm, or more, deep.

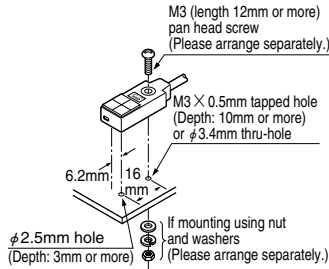

Influence of surrounding metal

- When there is a metal near the sensor, keep the minimum separation distance specified below.

GL-N12F□ × 10

(Unit: mm)

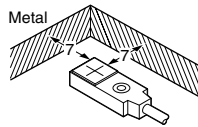
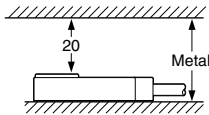

GL-N12H□ × 10

(Unit: mm)

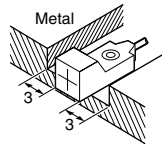
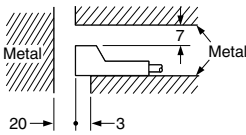

Mutual interference prevention

- When two or more sensors are installed in parallel or face to face, keep the minimum separation distance specified below to avoid mutual interference.

	GL-N12F□ × 10, GL-N12H□ × 10		GL-N12F□ × 10	GL-N12H□ × 10
	Between 'I' type and non 'I' type	Between two 'I' types or two non 'I' types		
A	0mm (Note 2)	25mm		
B	25mm	50mm		

- Notes: 1) 'I' in the model No. specifies the different frequency type.
 2) Close mounting is possible for up to two sensors.
 When mounting three sensors or more, at an equal spacing, in a row, the minimum value of dimension A should be 6.5mm.

Sensing range

- The sensing range is specified for the standard sensing object (iron sheet 20 × 20 × t1mm). With a non-ferrous metal, the sensing range is obtained by multiplying with the correction coefficient specified on the right. Further, the sensing range also change if the sensing object is smaller than the standard sensing object (iron sheet 20 × 20 × t1mm) or if the sensing object is plated.

Correction coefficient

Model No.	GL-N12F□ × 10	GL-N12H□ × 10
Iron	1	
Stainless steel (SUS304)	0.79 approx.	
Brass	0.56 approx.	
Aluminum	0.53 approx.	

Wiring

- The output is not incorporated with a short-circuit protection circuit. Do not connect it directly to a power supply or a capacitive load.

Others

- Do not use during the initial transient time (50ms) after the power supply is switched on.

GL-N12

DIMENSIONS (Unit: mm)

GL-N12F□ × 10 Sensor

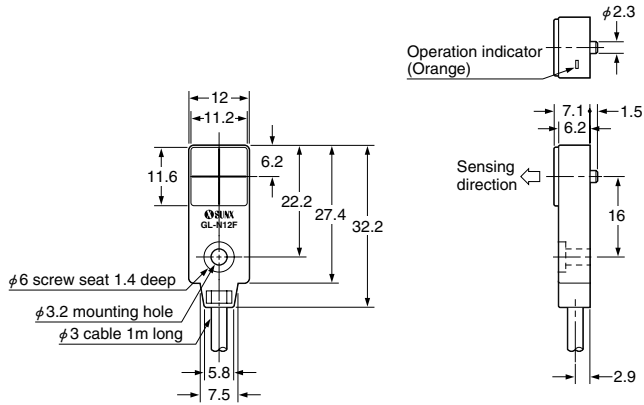

GL-N12H□ × 10 Sensor

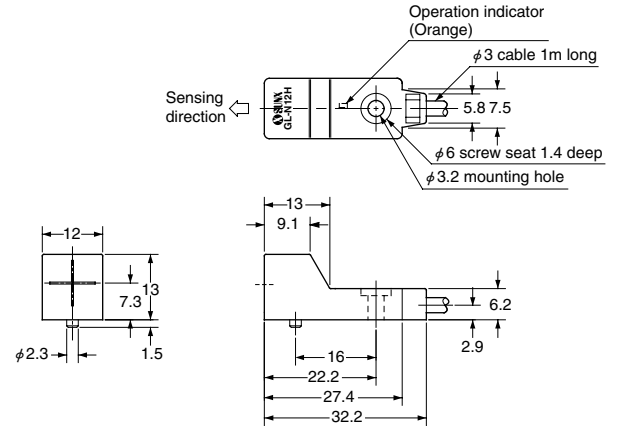

GL-12F × 10 Sensor

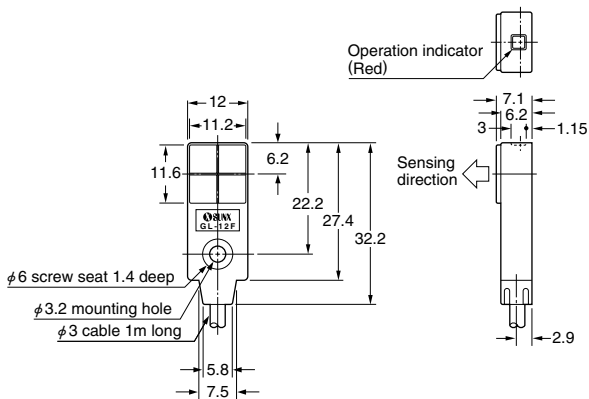

MS-GL12 × 10 Sensor mounting bracket (Optional)

Mounting hole dimensions

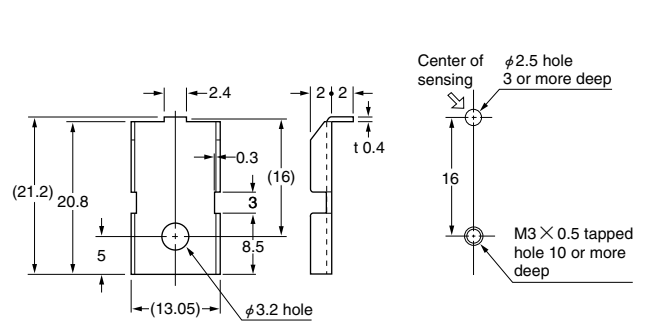

Material: Cold rolled carbon steel (SPCC)
(Nickel plated)

1 No. each of M3 (length 12mm) pan head screw, plain washer, spring washer and rubber washer ($\phi 9.5 \times t 0.5\text{mm}$) is attached.