

GXL SERIES

Micro-size Inductive Proximity Sensor

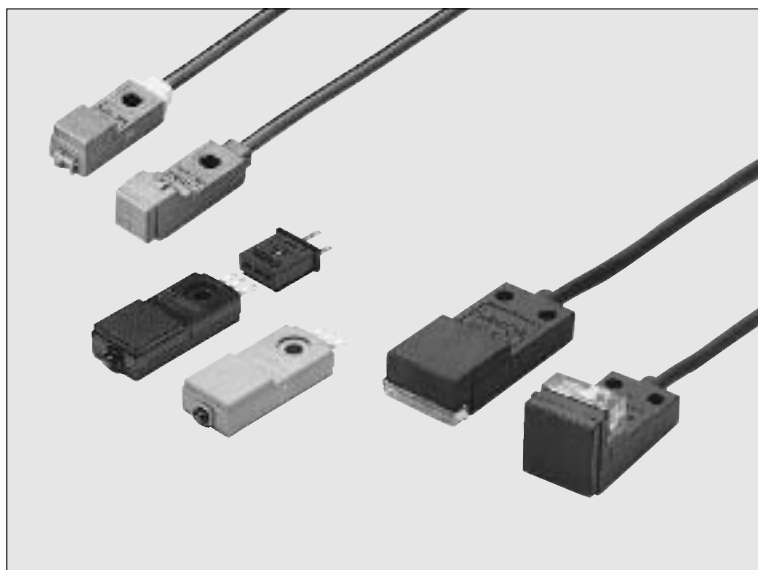

**High Performance
in Micro-size Design**

CE Marked
Conforming to EMC Directive

Wide Model Variety

Models ranging from extremely compact type to long sensing range type are available to suit various applications.

Versatile Mounting

Since the sensor is fingertip size, it can be mounted in a tight space.



Reduced Wiring Operation

The wiring cost of the DC 2-wire type is 2/3 that of a conventional model. Besides, the possibility of miswiring is reduced.

Particularly convenient when many sensors are used.

Wiring of the 3-wire type is cumbersome.

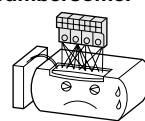

Wiring of the 2-wire type is simple and neat.

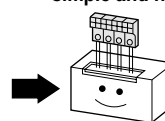

Inflection Resistant Cable Type

The inflection resistance of its cable is ten times that of the conventional model. The sensor can be mounted on a moving table or a robot arm.

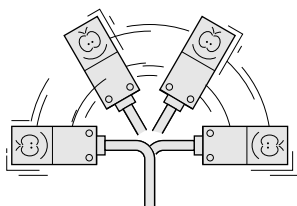

※ Except PNP output type and 5m cable attached NPN output type

APPLICATIONS

Detecting wafer frame

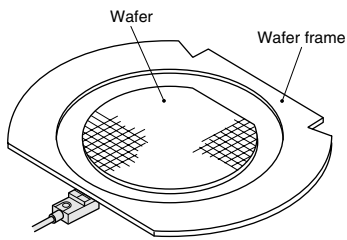

Detecting aluminum pallet

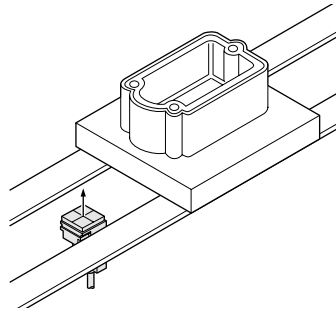

Code reading

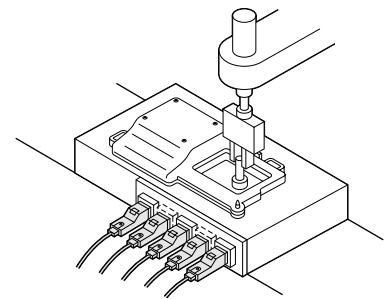

ORDER GUIDE

GXL-8 type

Type	Appearance (mm)	Sensing range (Note 1)	Model No. (Note 2)	Output	Output operation
DC 2-wire	Front sensing 	Maximum operation distance Stable sensing range (0 to 1.8mm)	GXL-8FU	Non-contact DC 2-wire type	Normally open
			GXL-8FUI		Normally closed
			GXL-8FUB		Normally open
	Top sensing 		GXL-8FUIB		Normally closed
			GXL-8HU		Normally open
			GXL-8HUI		Normally closed
NPN output	Front sensing 	Maximum operation distance Stable sensing range (0 to 1.8mm)	GXL-8HUB	NPN open-collector transistor	Normally open
			GXL-8HUIB		Normally closed
			GXL-8F		Normally open
	Top sensing 		GXL-8FI		Normally closed
			GXL-8FB		Normally open
			GXL-8FIB		Normally closed
NPN output	Front sensing 	Maximum operation distance Stable sensing range (0 to 1.8mm)	GXL-8H	NPN open-collector transistor	Normally open
			GXL-8HI		Normally closed
			GXL-8HB		Normally open
	Top sensing 		GXL-8HI		Normally closed
			GXL-8HB		Normally open
			GXL-8HIB		Normally closed

Notes: 1) The maximum operation distance stands for the maximum distance for which the sensor can detect the standard sensing object.
 The stable sensing range stands for the sensing range for which the sensor can stably detect the standard sensing object even if there is an ambient temperature drift and/or supply voltage fluctuation.
 2) 'I' in the model No. indicates a different frequency type.

GXL-N12 type

Type	Appearance (mm)	Sensing range (Note 1)	Model No. (Note 2)	Output	Output operation
NPN output	Cable type 	Maximum operation distance Stable sensing range (0 to 2mm)	GXL-N12F (Note 3)	NPN open-collector transistor	Normally open
			GXL-N12FI (Note 3)		Normally closed
			GXL-N12FB		Normally open
	Terminal type 		GXL-N12FT (Note 3)		Normally closed
			GXL-N12FTI (Note 3)		Normally open
			GXL-N12FTB		Normally closed
PNP output	Cable type 	Maximum operation distance Stable sensing range (0 to 2mm)	GXL-N12FTIB	PNP open-collector transistor	Normally open
			GXL-N12F-P		Normally closed
			GXL-N12FI-P		Normally open
	Terminal type 		GXL-N12FB-P		Normally closed
			GXL-N12FIB-P		Normally open
			GXL-N12FT-P		Normally closed
PNP output	Cable type 	Maximum operation distance Stable sensing range (0 to 2mm)	GXL-N12FTI-P	PNP open-collector transistor	Normally open
			GXL-N12FTB-P		Normally closed
			GXL-N12FTIB-P		Normally open
	Terminal type 		GXL-N12FTI-P		Normally closed
			GXL-N12FTB-P		Normally open
			GXL-N12FTIB-P		Normally closed

Notes: 1) The maximum operation distance stands for the maximum distance for which the sensor can detect the standard sensing object.
 The stable sensing range stands for the sensing range for which the sensor can stably detect the standard sensing object even if there is an ambient temperature drift and/or supply voltage fluctuation.
 2) 'I' in the model No. indicates a different frequency type.
 3) These models, with normally open NPN output, are also available as 5V supply voltage type. Please contact our office for details.

ORDER GUIDE

GXL-15 (Standard) type

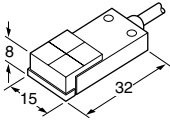
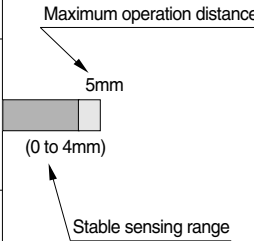
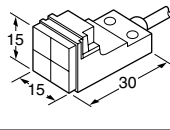
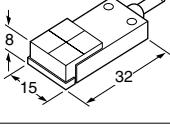
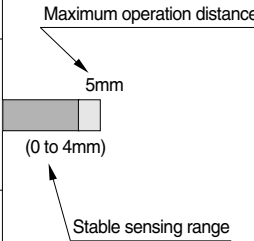
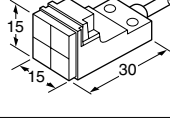
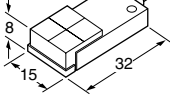
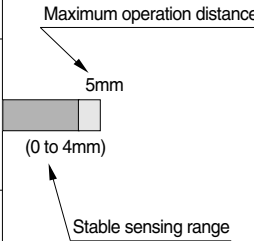
Type	Appearance (mm)	Sensing range (Note 1)	Model No. (Note 2)	Output	Output operation
DC 2-wire	Front sensing 		GXL-15FU	Non-contact DC 2-wire type	Normally open
			GXL-15FUI		Normally closed
			GXL-15FUB		Normally open
	GXL-15FUIB		Normally closed		
	Top sensing 		GXL-15HU		Normally open
			GXL-15HUI		Normally closed
GXL-15HUB		Normally open			
NPN output	Front sensing 		GXL-15HF	NPN open-collector transistor	Normally open
			GXL-15HFI		Normally closed
			GXL-15HFB		Normally open
	Top sensing 		GXL-15HFIB		Normally open
			GXL-15HHI		Normally closed
			GXL-15HHB		Normally open
PNP output	Front sensing 		GXL-15HF-P	PNP open-collector transistor	Normally open
			GXL-15HFI-P		Normally closed
			GXL-15HFB-P		Normally open

Notes: 1) The maximum operation distance stands for the maximum distance for which the sensor can detect the standard sensing object.
The stable sensing range stands for the sensing range for which the sensor can stably detect the standard sensing object even if there is an ambient temperature drift and/or supply voltage fluctuation.
2) ' I ' in the model No. indicates a different frequency type.

GXL-15 (Long sensing range) type ... For mounting on non-magnetic material (Note 3)

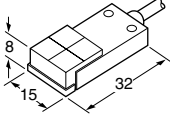
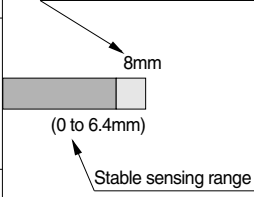
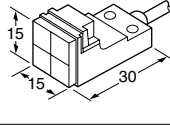
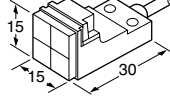
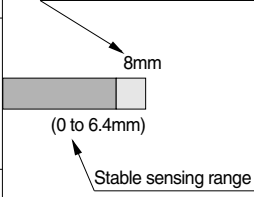
Type	Appearance (mm)	Sensing range (Note 1)	Model No. (Note 2)	Output	Output operation
DC 2-wire	Front sensing 		GXL-15FLU	Non-contact DC 2-wire type	Normally open
			GXL-15FLUI		Normally closed
			GXL-15FLUB		Normally open
	Top sensing 		GXL-15FLUIB		Normally closed
			GXL-15HLU		Normally open
			GXL-15HLUI		Normally closed
NPN output	Top sensing 		GXL-15HLUB	NPN open-collector transistor	Normally open
			GXL-15HLUIB		Normally closed
			GXL-15HL		Normally open
			GXL-15HLI		Normally closed

Notes: 1) The maximum operation distance stands for the maximum distance for which the sensor can detect the standard sensing object.
The stable sensing range stands for the sensing range for which the sensor can stably detect the standard sensing object even if there is an ambient temperature drift and/or supply voltage fluctuation.
2) ' I ' in the model No. indicates a different frequency type.
3) To mount the long sensing range **GXL-15** on a magnetic body, such as iron, the enclosed aluminum sheet, or any other aluminum sheet having a minimum size of 30×39.5×0.3mm (**GXL-15HLU**□ / **GXL-15HL**□: 30×30×0.3mm), should be inserted between the sensor and the magnetic body.
However, it is not necessary to use the aluminum sheet when mounting on a non-magnetic body, such as, aluminum or an insulator.

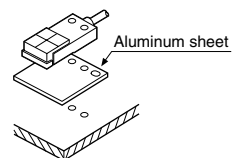

ORDER GUIDE

Inflection resistant cable type and 5m cable length type

Inflection resistant cable type and 5m cable length type are also available.

• **Table of Model Nos.**

Type	Standard	Inflection resistant cable type	5m cable length type	Inflection resistant cable & 5m cable length type	
DC 2-wire	Front sensing	GXL-8FU	GXL-8FU-R	GXL-8FU-C5	GXL-8FU-R-C5
		GXL-8FUI	GXL-8FUI-R	GXL-8FUI-C5	GXL-8FUI-R-C5
		GXL-8FUB	GXL-8FUB-R	GXL-8FUB-C5	GXL-8FUB-R-C5
		GXL-8FUIB	GXL-8FUIB-R	GXL-8FUIB-C5	GXL-8FUIB-R-C5
	Top sensing	GXL-8HU	GXL-8HU-R	GXL-8HU-C5	GXL-8HU-R-C5
		GXL-8HUI	GXL-8HUI-R	GXL-8HUI-C5	GXL-8HUI-R-C5
		GXL-8HUB	GXL-8HUB-R	GXL-8HUB-C5	GXL-8HUB-R-C5
		GXL-8HUIB	GXL-8HUIB-R	GXL-8HUIB-C5	GXL-8HUIB-R-C5
	Front sensing	GXL-15FU	GXL-15FU-R	GXL-15FU-C5	GXL-15FU-R-C5
		GXL-15FUI	GXL-15FUI-R	GXL-15FUI-C5	GXL-15FUI-R-C5
		GXL-15FUB	GXL-15FUB-R	GXL-15FUB-C5	GXL-15FUB-R-C5
		GXL-15FUIB	GXL-15FUIB-R	GXL-15FUIB-C5	GXL-15FUIB-R-C5
	Top sensing	GXL-15HU	GXL-15HU-R	GXL-15HU-C5	GXL-15HU-R-C5
		GXL-15HUI	GXL-15HUI-R	GXL-15HUI-C5	GXL-15HUI-R-C5
		GXL-15HUB	GXL-15HUB-R	GXL-15HUB-C5	GXL-15HUB-R-C5
		GXL-15HUIB	GXL-15HUIB-R	GXL-15HUIB-C5	GXL-15HUIB-R-C5
	Front sensing	GXL-15FLU	GXL-15FLU-R	GXL-15FLU-C5	GXL-15FLU-R-C5
		GXL-15FLUI	GXL-15FLUI-R	GXL-15FLUI-C5	GXL-15FLUI-R-C5
		GXL-15FLUB	GXL-15FLUB-R	GXL-15FLUB-C5	GXL-15FLUB-R-C5
		GXL-15FLUIB	GXL-15FLUIB-R	GXL-15FLUIB-C5	GXL-15FLUIB-R-C5
	Top sensing	GXL-15HLU	GXL-15HLU-R	GXL-15HLU-C5	GXL-15HLU-R-C5
		GXL-15HLUI	GXL-15HLUI-R	GXL-15HLUI-C5	GXL-15HLUI-R-C5
		GXL-15HLUB	GXL-15HLUB-R	GXL-15HLUB-C5	GXL-15HLUB-R-C5
		GXL-15HLUIB	GXL-15HLUIB-R	GXL-15HLUIB-C5	GXL-15HLUIB-R-C5
NPN output	Front sensing	GXL-8F	GXL-8F-R	GXL-8F-C5	_____
		GXL-8FI	GXL-8FI-R	GXL-8FI-C5	_____
		GXL-8FB	GXL-8FB-R	GXL-8FB-C5	_____
		GXL-8FIB	GXL-8FIB-R	GXL-8FIB-C5	_____
	Top sensing	GXL-8H	GXL-8H-R	GXL-8H-C5	_____
		GXL-8HI	GXL-8HI-R	GXL-8HI-C5	_____
		GXL-8HB	GXL-8HB-R	GXL-8HB-C5	_____
		GXL-8HIB	GXL-8HIB-R	GXL-8HIB-C5	_____
	Front sensing	GXL-N12F	GXL-N12F-R	GXL-N12F-C5	_____
		GXL-N12FI	GXL-N12FI-R	GXL-N12FI-C5	_____
		GXL-N12FB	GXL-N12FB-R	GXL-N12FB-C5	_____
		GXL-N12FIB	GXL-N12FIB-R	GXL-N12FIB-C5	_____
	Top sensing	GXL-N12FT	_____	_____	_____
		GXL-N12FTI	_____	_____	_____
		GXL-N12FTB	_____	_____	_____
		GXL-N12FTIB	_____	_____	_____
	Front sensing	GXL-15F	GXL-15F-R	GXL-15F-C5	_____
		GXL-15FI	GXL-15FI-R	GXL-15FI-C5	_____
		GXL-15FB	GXL-15FB-R	GXL-15FB-C5	_____
		GXL-15FIB	GXL-15FIB-R	GXL-15FIB-C5	_____
	Top sensing	GXL-15H	_____	_____	_____
		GXL-15HI	_____	_____	_____
		GXL-15HB	_____	_____	_____
		GXL-15HIB	_____	_____	_____
Top sensing	GXL-15HL	_____	_____	_____	
	GXL-15HLI	_____	_____	_____	
	GXL-15HLB	_____	_____	_____	
	GXL-15HLIB	_____	_____	_____	
PNP output	Front sensing	GXL-N12F-P	_____	GXL-N12F-P-C5	_____
		GXL-N12FI-P	_____	GXL-N12FI-P-C5	_____
		GXL-N12FB-P	_____	GXL-N12FB-P-C5	_____
		GXL-N12FIB-P	_____	GXL-N12FIB-P-C5	_____
	Top sensing	GXL-N12FT-P	_____	_____	_____
		GXL-N12FTI-P	_____	_____	_____
		GXL-N12FTB-P	_____	_____	_____
		GXL-N12FTIB-P	_____	_____	_____
Front sensing	GXL-15F-P	_____	GXL-15F-P-C5	_____	
	GXL-15FI-P	_____	GXL-15FI-P-C5	_____	
	GXL-15FB-P	_____	GXL-15FB-P-C5	_____	
	GXL-15FIB-P	_____	GXL-15FIB-P-C5	_____	

OPTIONS

Designation	Model No.	Description
Connector	CN-13	Connector for the terminal type
	CN-13-C1	Length: 1m
	CN-13-C3	Length: 3m
Sensor mounting bracket	MS-GXL8-3	Mounting bracket for NPN output of GXL-8 type
	MS-GXL12-2	Mounting bracket for GXL-N12 type
	MS-GXL15	Mounting bracket for GXL-15 type
	MS-GXL15-2	Mounting bracket for GXL-15F type

Connector

• CN-13

• CN-13-C1

• CN-13-C3

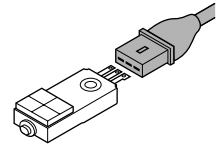
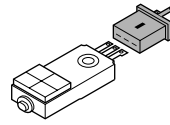

Sensor mounting bracket

• MS-GXL8-3

• MS-GXL12-2

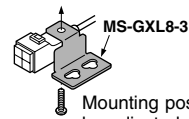

Mounting position can be adjusted. It is rust-free, being stainless steel.

A set of one pan head screw and two screws with washers is attached.

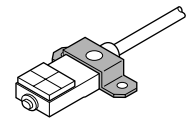

Screws are not supplied.

• MS-GXL15

• MS-GXL15-2

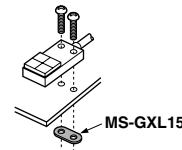

Screws are not supplied.

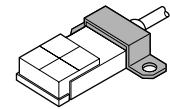

SPECIFICATIONS

DC 2-wire type

Item	Standard Model No.	Type	GXL-15 type					
			GXL-8 type		Standard		Long sensing range (For mounting on non-magnetic body) (Note 1)	
			Front sensing	Top sensing	Front sensing	Top sensing	Front sensing	Top sensing
			GXL-8FU	GXL-8HU	GXL-15FU	GXL-15HU	GXL-15FLU	GXL-15HLU
Max. operation distance (Note 2)			2.5mm ± 20%		5mm ± 10%		8mm ± 10%	
Stable sensing range (Note 2)			0 to 1.8mm		0 to 4mm		0 to 6.4mm	
Standard sensing object			Iron sheet 15 × 15 × t1mm		Iron sheet 20 × 20 × t1mm		Iron sheet 30 × 30 × t1mm	
Hysteresis			20% or less of operation distance					
Repeatability			Along sensing axis, perpendicular to sensing axis: 0.04mm or less					
Supply voltage			12 to 24V DC ± 10% Ripple P-P 10% or less					
Current consumption (Note 3)			0.8mA or less					
Output			Non-contact DC 2-wire type • Load current: 3 to 70mA (Note 4) • Residual voltage: 3V or less (Note 5)		Non-contact DC 2-wire type • Load current: 3 to 100mA (Note 4) • Residual voltage: 3V or less (Note 5)			
	Utilization category		DC-12 or DC-13					
	Short-circuit protection		Incorporated					
Max. response frequency			1kHz					
Operation indicator			Normally closed type: Red LED (lights up when the output is ON)					
2-color indicator			Normally open type: Lights up in green under stable sensing condition Lights up in red under unstable sensing condition					
Environmental resistance	Pollution degree		3 (Industrial environment)					
	Protection		IP67 (IEC), IP67g (JEM)					
	Ambient temperature		− 25 to + 70°C, Storage: − 30 to + 80°C					
	Ambient humidity		45 to 85% RH, Storage: 35 to 95% RH					
	EMC		Emission: EN50081-2, Immunity: EN50082-2					
	Voltage withstandability		1,000V AC for one min. between all supply terminals connected together and enclosure					
	Insulation resistance		50MΩ, or more, with 250V DC megger between all supply terminals connected together and enclosure					
	Vibration resistance		10 to 55Hz frequency, 1.5mm amplitude in X, Y and Z directions for two hours each					
	Shock resistance		1,000m/s ² acceleration (100G approx.) in X, Y and Z directions for three times each					
Sensing range variation	Temperature characteristics		Over ambient temperature range − 25 to + 70°C: within $\pm 15\%$ of sensing range at 20°C					
	Voltage characteristics		Within ± 2% for ± 10% fluctuation of the supply voltage					
Material			Enclosure: PBT, Indicator part: Polyallylate		Enclosure: PET (Glass fiber reinforced) Indicator part: Polyallylate	Enclosure: PBT Indicator part: Polyallylate	Enclosure: PET (Glass fiber reinforced) Indicator part: Polyallylate	
Cable (Note 6)			0.15mm ² 2-core oil, heat and cold resistant cable, 1m long		0.2mm ² 2-core oil, heat and cold resistant cable, 1m long			
Cable extension			Extension up to total 50m is possible with 0.3mm ² , or more, cable.					
Weight			12g approx.		20g approx.			
Accessory			MS-GXL8-4 (Sensor mounting bracket): 1 set			MS-A15F (Aluminum sheet): 1 No.	MS-A15H (Aluminum sheet): 1 No.	

Notes: 1) To mount the long sensing range **GXL-15** type on a magnetic body, such as iron, the enclosed aluminum sheet, or any other aluminum sheet having a minimum size of 30 × 39.5 × t0.3mm (**GXL-15HLU** type: 30 × 30 × t0.3mm), should be inserted between the sensor and the magnetic body. However, it is not necessary to use the aluminum sheet when mounting on a non-magnetic body, such as, aluminum or an insulator.

2) The maximum operation distance stands for the maximum distance for which the sensor can detect the standard sensing object.

The stable sensing range stands for the sensing range for which the sensor can stably detect the standard sensing object even if there is an ambient temperature drift and/or supply voltage fluctuation.

3) It is the leakage current when the output is in the OFF state.

4) The maximum load current varies with the ambient temperature. Refer to 'I/O CIRCUIT AND WIRING DIAGRAMS' for more details.

5) When the cable is extended, the residual voltage becomes larger according to the resistance of the cable.

The residual voltage of 5m cable length type increases by 0.1V.

6) The inflection resistant cable type (model No. with suffix '-R') has a 0.15mm² (**GXL-15** type: 0.2mm²) inflection, oil, heat and cold resistant cable, 1m long.

SPECIFICATIONS

NPN and PNP output type

Item	Standard model No.	NPN output						PNP output			
		GXL-8 type		GXL-N12 type		GXL-15 type		GXL-N12 type		GXL-15 type	
				Cable type	Terminal type	Standard	Long sensing range (For mounting on non-magnetic body) (Note 1)	Cable type	Terminal type	Standard	
		Front sensing	Top sensing	Front sensing				Front sensing	Top sensing	Top sensing	Front sensing
		GXL-8F	GXL-8H	GXL-N12F	GXL-N12FT	GXL-15F	GXL-15H	GXL-15HL	GXL-N12F-P	GXL-N12FT-P	GXL-15F-P
Max. operation distance (Note 2)		2.5mm ± 20%		3mm ± 10%		5mm ± 10%		8mm ± 10%	3mm ± 10%		5mm ± 10%
Stable sensing range (Note 2)		0 to 1.8mm		0 to 2mm		0 to 4mm		0 to 6.4mm	0 to 2mm		0 to 4mm
Standard sensing object		Iron sheet 15 × 15 × 1mm		Iron sheet 20 × 20 × 1mm				Iron sheet 30 × 30 × 1mm	Iron sheet 20 × 20 × 1mm		
Hysteresis		20% or less of operation distance									
Repeatability		Along sensing axis, perpendicular to sensing axis: 0.04mm or less					Along sensing axis, perpendicular to sensing axis: 0.06mm or less		Along sensing axis, perpendicular to sensing axis: 0.04mm or less		
Supply voltage		12 to 24V DC ± 10% Ripple P-P 10% or less									
Current consumption		15mA or less									
Output		NPN open-collector transistor • Maximum sink current: 100mA • Applied voltage: 30V DC or less (between output and 0V) • Residual voltage: 1V or less (at 100mA sink current) 0.4V or less (at 16mA sink current)						PNP open-collector transistor • Maximum source current: 100mA • Applied voltage: 30V DC or less (between output and +V) • Residual voltage: 1V or less (at 100mA source current) 0.4V or less (at 16mA source current)			
Utilization category		DC-12 or DC-13									
Short-circuit protection		—									
Max. response frequency		500Hz				250Hz			500Hz		250Hz
Operation indicator		Red LED (lights up when the output is ON)									
Environmental resistance	Pollution degree	3 (Industrial environment)									
	Protection	IP67 (IEC), IP67g (JEM) except for the terminal type									
	Ambient temperature	− 10 to + 55°C, Storage: − 30 to + 80°C									
	Ambient humidity	45 to 85% RH, Storage: 35 to 95% RH									
	EMC	Emission: EN50081-2, Immunity: EN50082-2									
	Voltage withstandability	1,000V AC for one min. between all supply terminals connected together and enclosure									
	Insulation resistance	50MΩ, or more, with 250V DC megger between all supply terminals connected together and enclosure									
	Vibration resistance	10 to 55Hz frequency, 1.5mm amplitude in X, Y and Z directions for two hours each									
	Shock resistance	1,000m/s ² acceleration (100G approx.) in X, Y and Z directions for three times each									
Sensing range variation	Temperature characteristics	Over ambient temperature range − 10 to + 55°C: within $\pm \frac{15}{10}$ % of sensing range at 20°C									
	Voltage characteristics	Within ± 2% for ± 10% fluctuation of the supply voltage									
Material		Enclosure: PBT, Indicator part: Polyallylate					Enclosure: PET (Glass fiber reinforced) Indicator part: Polyallylate		Enclosure: PBT Indicator part: Polyallylate		
Cable (Note 3)		0.08mm ² 3-core oil, heat and cold resistant cabtyre cable, 1m long		0.15mm ² 3-core oil, heat and cold resistant cabtyre cable, 1m long	—	0.15mm ² 3-core oil, heat and cold resistant cabtyre cable, 1m long			—	0.15mm ² 3-core oil, heat and cold resistant cabtyre cable, 1m long	
Cable extension		Extension up to total 100m is possible with 0.3mm ² , or more, cable.									
Weight		12g approx.	20g approx.	5g approx.	20g approx.				5g approx.	20g approx.	
Accessories		MS-GXL8 (Sensor mounting bracket): 1 set		MS-GXL12-1 (Sensor mounting bracket): 1 No. M3 pan head screw, plain washer, spring washer and nut: 1 set MS-R1 (Rubber washer): 1 No.			—		MS-A15H (Aluminum sheet): 1 No.	MS-GXL12-1 (Sensor mounting bracket): 1 No. M3 pan head screw, plain washer, spring washer and nut: 1 set MS-R1 (Rubber washer): 1 No.	

- Notes: 1) To mount the long sensing range GXL-15 type on a magnetic body, such as iron, the enclosed aluminum sheet or any other aluminum sheet having a minimum size of 30 × 30 × 10.3mm, should be inserted between the sensor and the magnetic body.
However, it is not necessary to use the aluminum sheet when mounting on a non-magnetic body, such as, aluminum or an insulator.
- 2) The maximum operation distance stands for the maximum distance for which the sensor can detect the standard sensing object.
The stable sensing range stands for the sensing range for which the sensor can stably detect the standard sensing object even if there is an ambient temperature drift and/or supply voltage fluctuation.
- 3) The inflection resistant cable type (model No. with suffix '-R') has a 0.15mm² (GXL-8 type: 0.1mm²) inflection, oil, heat and cold resistant cabtyre cable, 1m long.

I/O CIRCUIT AND WIRING DIAGRAMS

DC 2-wire type

GXL-8FU/GXL-8HU type

I/O circuit diagram

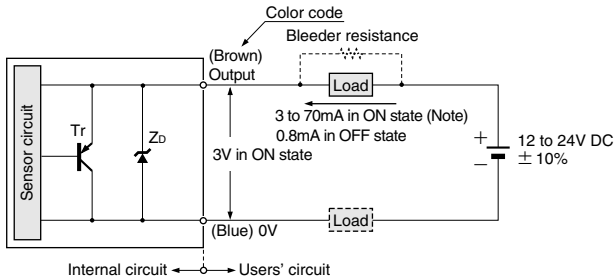

Symbols ... Z_d: Surge absorption zener diode
Tr: PNP output transistor

Note: The maximum load current varies depending on the ambient temperature.

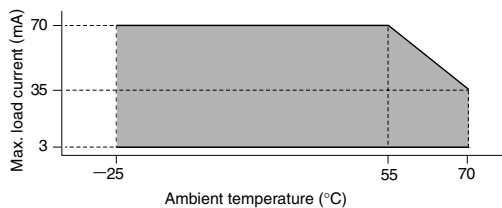

Wiring diagram

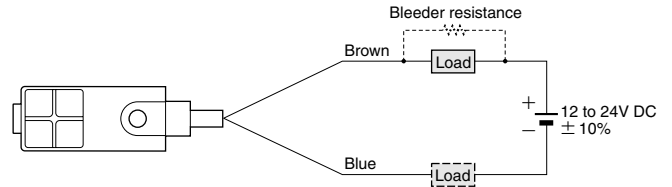

Conditions for the load

- 1) The load should not be actuated by the leakage current (0.8mA) in the OFF state.
- 2) The load should be actuated by (supply voltage - 3V) in the ON state.
- 3) The current in the ON state should be between 3 to 70mA DC.
[In case the current is less than 3mA, connect a bleeder resistance]
[in parallel to the load so that a current of 3mA, or more, flows.]

GXL-15FU/GXL-15HU/GXL-15FLU/GXL-15HLU type

I/O circuit diagram

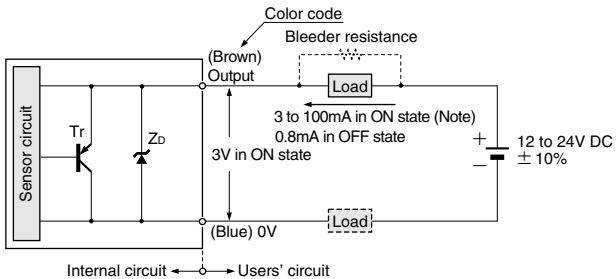

Symbols ... Z_d: Surge absorption zener diode
Tr: PNP output transistor

Note: The maximum load current varies depending on the ambient temperature.

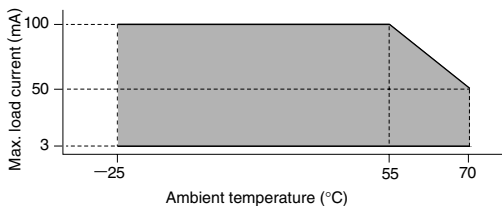

Wiring diagram

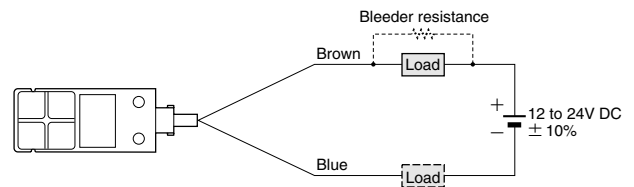

Conditions for the load

- 1) The load should not be actuated by the leakage current (0.8mA) in the OFF state.
- 2) The load should be actuated by (supply voltage - 3V) in the ON state.
- 3) The current in the ON state should be between 3 to 100mA DC.
[In case the current is less than 3mA, connect a bleeder resistance]
[in parallel to the load so that a current of 3mA, or more, flows.]

I/O CIRCUIT AND WIRING DIAGRAMS

NPN output type

I/O circuit diagram

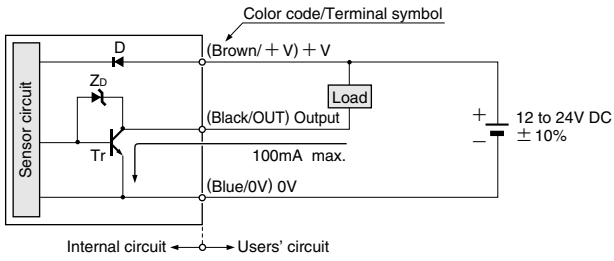

Wiring diagram

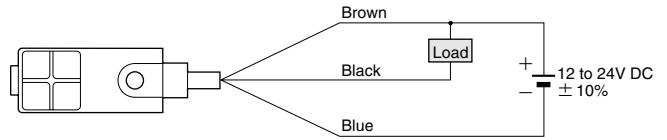

Symbols ... D: Reverse supply polarity protection diode
 Zd: Surge absorption zener diode
 Tr: NPN output transistor

PNP output type

I/O circuit diagram

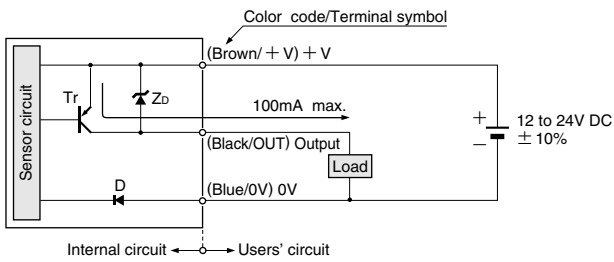

Wiring diagram

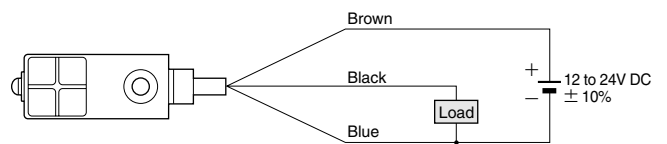

Symbols ... D: Reverse supply polarity protection diode
 Zd: Surge absorption zener diode
 Tr: PNP output transistor

SENSING CHARACTERISTICS (TYPICAL)

GXL-8 type

Sensing field (common)

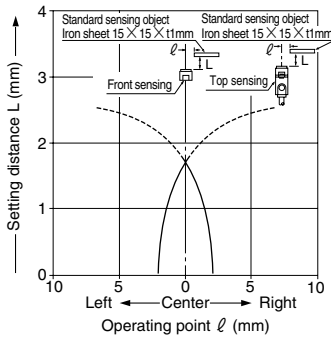

Correlation between sensing object size and sensing range (DC 2-wire type)

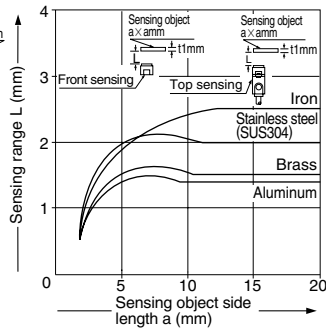

Correlation between sensing object size and sensing range (NPN output type)

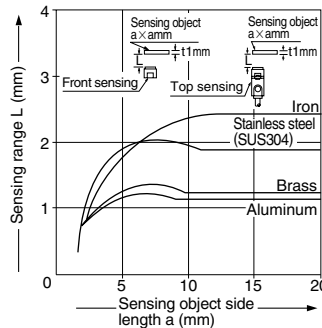

As the sensing object size becomes smaller than the standard size (iron sheet 15 × 15 × 1mm), the sensing range shortens as shown in the left figures.

GXL-N12 type

Sensing field

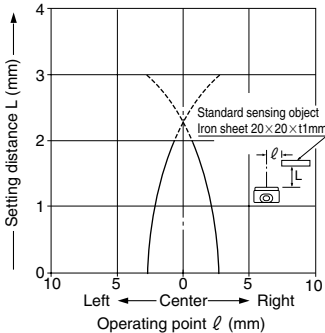

Correlation between sensing object size and sensing range

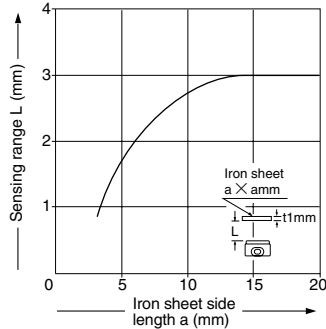

As the sensing object size becomes smaller than the standard size (iron sheet 20 × 20 × 1mm), the sensing range shortens as shown in the left figure.

GXL-15 (Standard) type

Sensing field

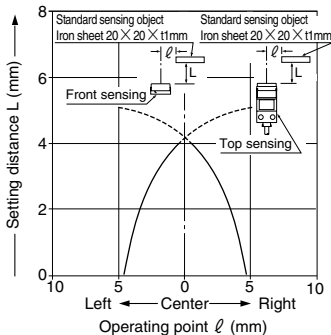

Correlation between sensing object size and sensing range

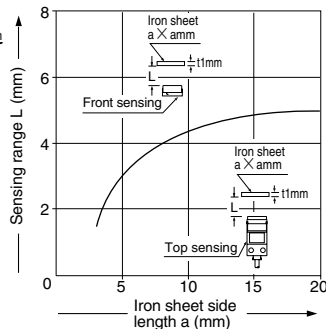

As the sensing object size becomes smaller than the standard size (iron sheet 20 × 20 × 1mm), the sensing range shortens as shown in the left figure.

GXL-15 (Long sensing range) type

Sensing field

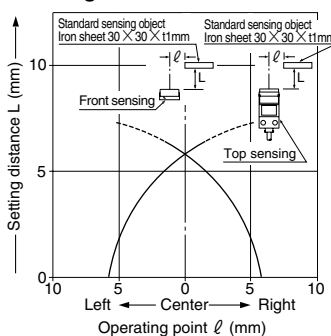

Correlation between sensing object size and sensing range

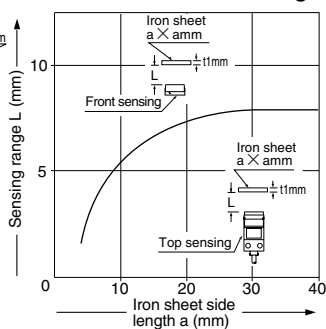

As the sensing object size becomes smaller than the standard size (iron sheet 30 × 30 × 1mm), the sensing range shortens as shown in the left figure.

GXL

PRECAUTIONS FOR PROPER USE

All models



This product is not a safety sensor. Its use is not intended or designed to protect life and prevent body injury or property damage from dangerous parts of machinery. It is a normal object detection sensor.

Mounting

GXL-8 (DC 2-wire) type

The tightening torque should be 0.5N·m or less.

To mount the sensor with a nut, the thru-hole diameter should be $\phi 3.4$ mm. With the attached mounting screw and nut, take care that the thickness of the mounting plate should be 2.3mm or less.

If a screw other than the attached screw is used, make sure to use a M3 truss head screw. (Do not use a flat head screw) or a pan head screw.

GXL-8 (NPN output) type

The tightening torque should be 0.5N·m or less.

To mount the sensor with a nut, the thru-hole diameter should be $\phi 3$ mm. With the attached mounting screw and nut, take care that the thickness of the mounting plate should be 2.3mm or less.

If a screw other than the attached screw is used, make sure to use a M2.6 truss head screw.

Note: Do not use a M3 screw.

GXL-N12 type

<One point fixing>

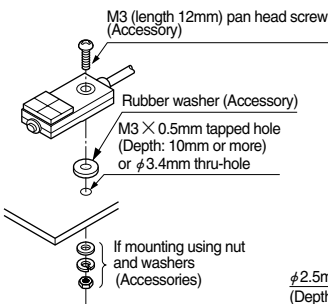

<Two point fixing>

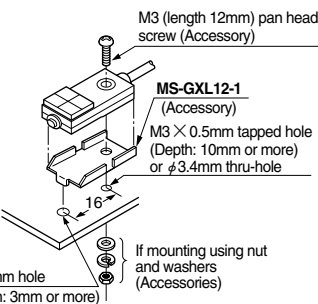

The tightening torque should be 0.49N·m or less.
To mount the sensor with a nut, the thru-hole diameter should be $\phi 3.4$ mm.

GXL-15 type

The tightening torque should be 1N·m or less.

To mount the sensor with the optional sensor mounting bracket **MS-GXL15**, the thru-hole diameter should be $\phi 3.4$ mm.

Screw, nut or washers are not supplied. Please arrange them separately.

To mount the long sensing range **GXL-15** type on a magnetic body, such as iron, the enclosed aluminum sheet, or any other aluminum sheet having a minimum size of $30 \times 39.5 \times t0.3$ mm (**GXL-15HLU**□/ **GXL-15HL**□: $30 \times 30 \times t0.3$ mm), should be inserted between the sensor and the magnetic body.

However, it is not necessary to use the aluminum sheet when mounting on a non-magnetic body, such as, aluminum or an insulator.

When mounting the inductive proximity sensor with the optional sensor mounting bracket **MS-GXL15-2**, if the bracket is mounted close to the sensing part, the bracket itself gets sensed and the operation becomes unstable. Make sure to mount such that the mounting holes of the sensor and those of the mounting bracket are in one horizontal straight line.

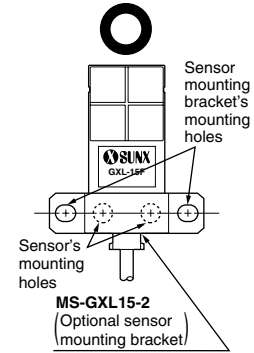
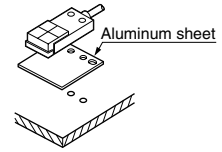
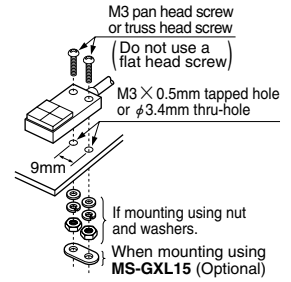

Influence of surrounding metal

When there is a metal near the sensor, keep the minimum separation distance specified below.

Front sensing type

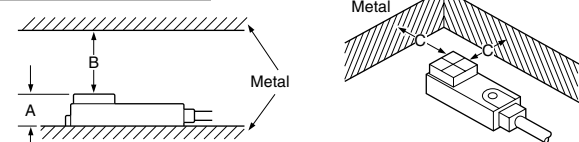

	GXL-8F type	GXL-N12F type	GXL-15FU/GXL-15F type	GXL-15FLU type
A	7mm	7mm	8mm	8mm (Note)
B	8mm	20mm	20mm	30mm
C	3mm	10mm	7mm	10mm

Note: The **GXL-15FLU** type should be mounted on an insulator or a non-magnetic body. To mount it on a magnetic body, such as iron, use the enclosed aluminum sheet.

Top sensing type

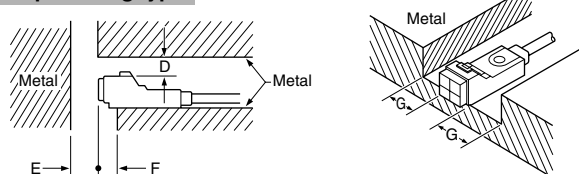

	GXL-8H type	GXL-15HU/GXL-15H type	GXL-15HLU/GXL-15HL type
D	4mm	6mm	12mm
E	10mm	20mm	30mm
F	3mm	0mm	10mm (Note)
G	3mm	3mm	10mm

Note: When **GXL-15HLU/GXL-15HL** type is mounted on an insulator or a non-magnetic body, or seated on the enclosed aluminum sheet, the distance 'F' can be zero.

PRECAUTIONS FOR PROPER USE

All models

Mutual interference prevention

- When two or more sensors are installed in parallel or face to face, keep the minimum separation distance specified below to avoid mutual interference.

		H	J
GXL-8 type	Between 'I' type and non 'I' type	0mm (Note 2)	15mm
	Between two 'I' types or two non 'I' types	12mm	30mm
GXL-N12 type	Between 'I' type and non 'I' type	0mm (Note 2)	15mm
	Between two 'I' types or two non 'I' types	20mm	40mm
GXL-15F GXL-15FU GXL-15HU	Between 'I' type and non 'I' type	0mm (Note 2)	25mm
GXL-15H type	Between 'I' type and non 'I' type	0mm (Note 2)	25mm
	Between two 'I' types or two non 'I' types	40mm	60mm
GXL-15FLU GXL-15HLU	Between 'I' type and non 'I' type	0mm (Note 2)	25mm
	Between two 'I' types or two non 'I' types	75mm	90mm
GXL-15HL type	Between 'I' type and non 'I' type	0mm (Note 2)	25mm
	Between two 'I' types or two non 'I' types	80mm	95mm

Front sensing

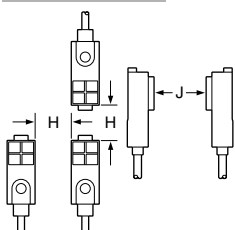

Top sensing

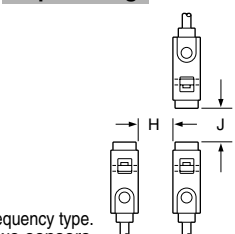

- Notes: 1) 'I' in the model No. specifies the different frequency type.
 2) Close mounting is possible for up to two sensors.
 When mounting three sensors or more, at an equal spacing, in a row, the minimum value of dimension H should be as given below.
GXL-8 type: 2mm, **GXL-N12 type:** 4mm
GXL-15 (Standard) type: 7.5mm (**GXL-15H type:** 12.5mm)
GXL-15 (Long sensing range) type: 30mm (**GXL-15HL type:** 32.5mm)

Sensing range

- The sensing range is specified for the standard sensing object. With a non-ferrous metal, the sensing range is obtained by multiplying with the correction coefficient specified below. Further, the sensing range also changes if the sensing object is plated.

Correction coefficient

Model No.	GXL-8FU GXL-8HU type	GXL-8F GXL-8H type	GXL-N12 type	GXL-15FU type	GXL-15HU GXL-15FLU GXL-15HLU type	GXL-15F GXL-15H type	GXL-15HL type
Metal							
Iron	1	1	1	1	1	1	1
Stainless steel (SUS304)	0.82 approx.	0.76 approx.	0.7 approx.	0.74 approx.	0.75 approx.	0.68 approx.	0.76 approx.
Brass	0.59 approx.	0.5 approx.	0.4 approx.	0.53 approx.	0.53 approx.	0.47 approx.	0.5 approx.
Aluminum	0.57 approx.	0.48 approx.	0.35 approx.	0.52 approx.	0.51 approx.	0.45 approx.	0.48 approx.

Others

- Do not use during the initial transient time (50ms) after the power supply is switched on.
- The output is not incorporated with a short-circuit protection circuit. Do not connect it directly to a power supply or a capacitive load (excluding the DC 2-wire type).

GXL-N12FT type

Soldering

- To solder the terminals of the sensor, observe the following conditions.

Soldering temperature: 260°C or less
 Soldering time : 5 sec. or less
 Soldering position : 1.5mm, or more, away from the sensor body.

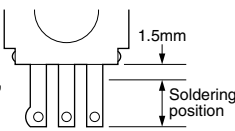

DC 2-wire type

Wiring

- The sensor must be connected to a power supply via a load. If the sensor is connected to a power supply without a load, the short-circuit protection makes the sensor inoperable. (The output stays in the OFF state and the indicator does not light up.) In this case, rectify by connecting the power supply via a load. Now, the sensor becomes operable. Further, take care that if the power supply is connected with reverse polarity without a load, the sensor will get damaged.

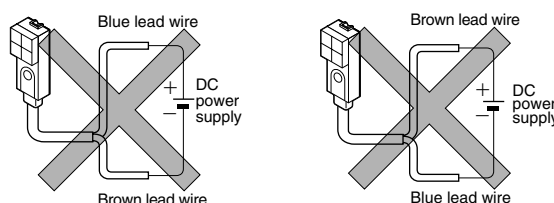

- For series connection (AND circuit) or parallel connection (OR circuit) of sensors, take care of the following.

Series connection (AND circuit)

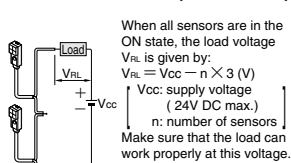

Parallel connection (OR circuit)

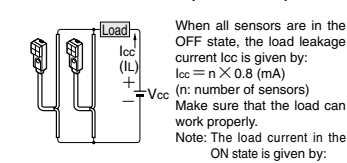

$$I_L = \frac{V_{CC} - 3V}{\text{Load resistance}} \text{ (mA)}$$

GXL-8 type :
 $3\text{mA} \times n \leq I_L \leq 70\text{mA}$
 n : number of sensors
 turned ON

GXL-15 type :
 $3\text{mA} \times n \leq I_L \leq 100\text{mA}$
 n : number of sensors
 turned ON

Note: The output is generated normally even if the indicator does not light up properly.

- The residual voltage of the sensor is 3V. Before connecting a relay at the load, take care of its actuation voltage. (Some 12V relays may not be usable.)

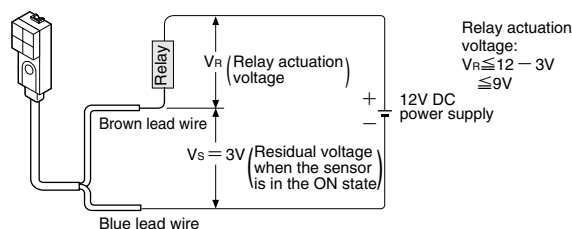

2-color indicator (Normally open type only)

- When the sensing object is in the stable sensing range, the LED lights up in green, and when the sensing object is in the unstable sensing range, the LED lights up in red. While the LED lights up in green, the sensing is performed stably without being affected by temperature drifts or voltage fluctuations.

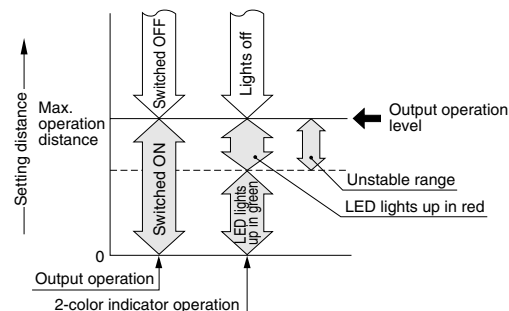

GXL

DIMENSIONS (Unit: mm)

GXL-8FU type Sensor

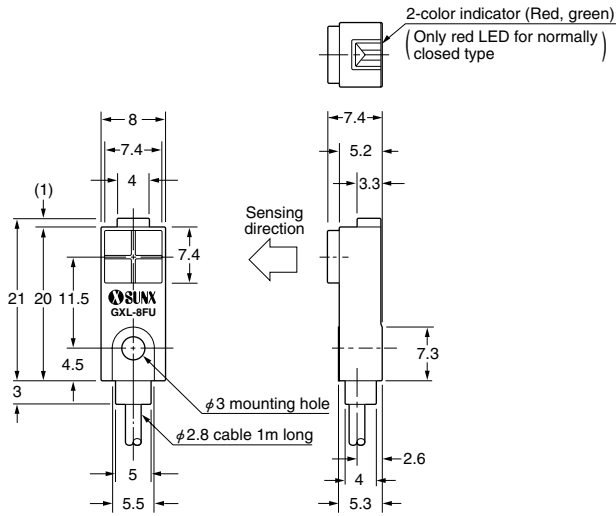

GXL-8HU type Sensor

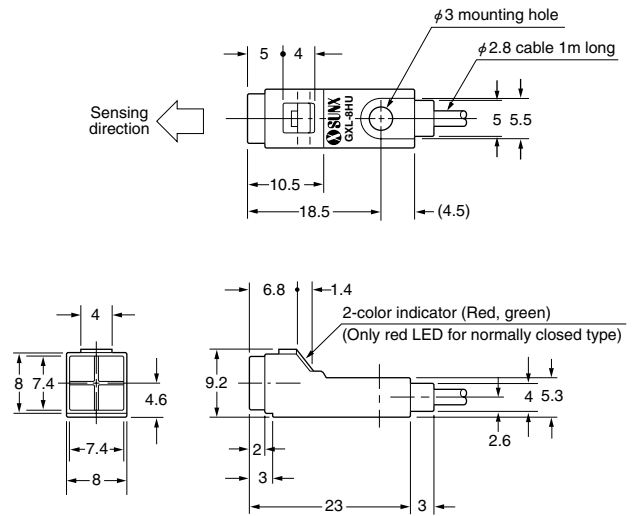

GXL-8F type Sensor

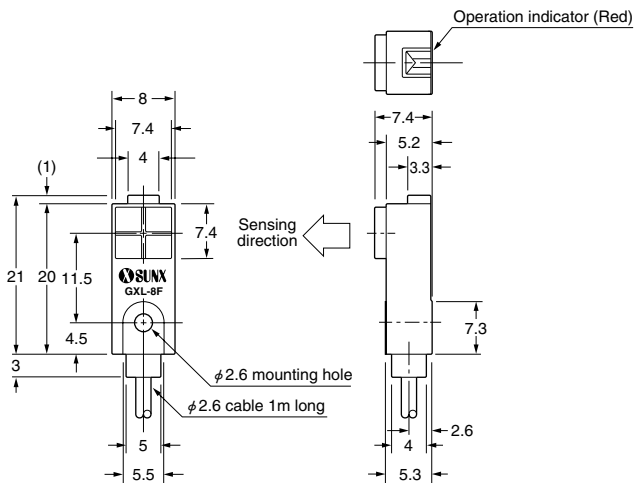

GXL-8H type Sensor

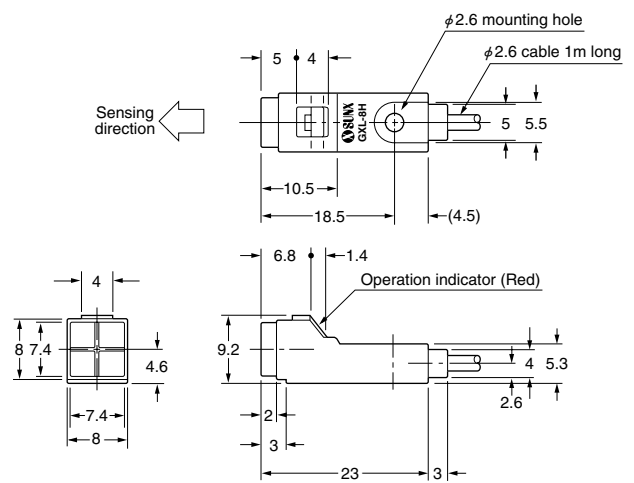

GXL-N12F type Sensor

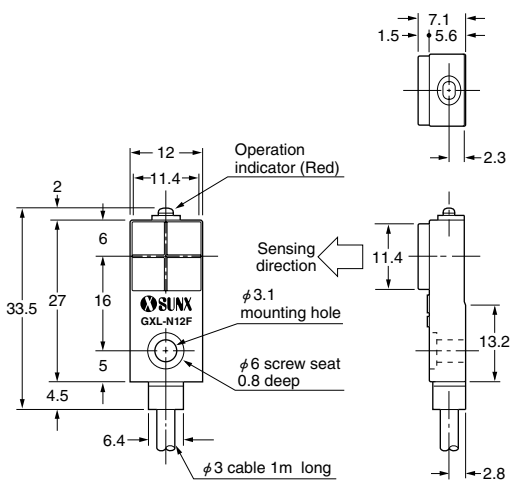

GXL-N12FT type Sensor

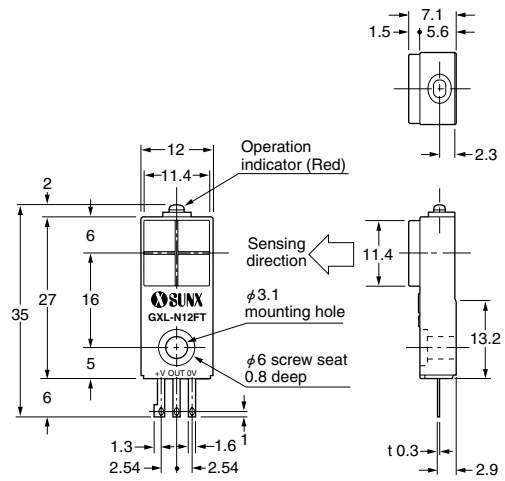

DIMENSIONS (Unit: mm)

GXL-15F type Sensor

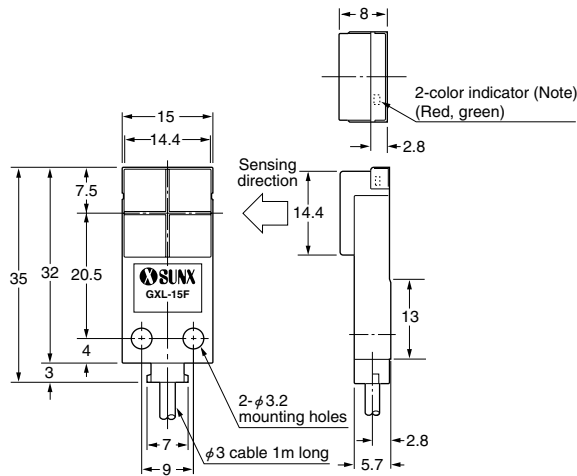

Note: Normally closed DC 2-wire type, NPN output type and PNP output type have an operation indicator (red) instead of the 2-color indicator.

GXL-15H type Sensor

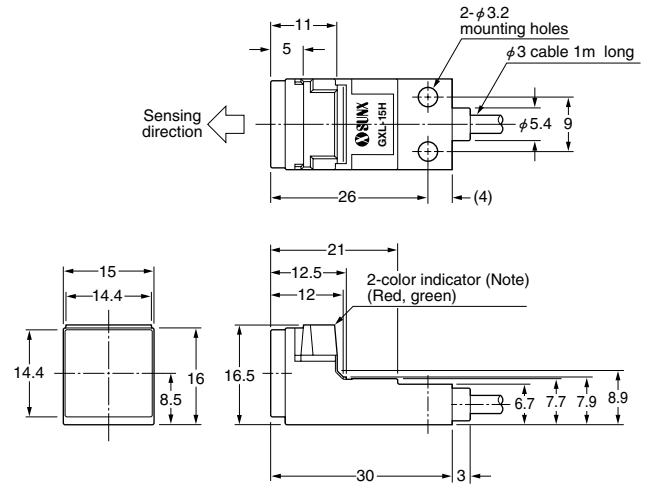

Note: Normally closed DC 2-wire type and NPN output type have an operation indicator (red) instead of the 2-color indicator.

MS-GXL8-4 Sensor mounting bracket for GXL-8FU/GXL-8HU type (Accessory)

Mounting hole dimensions

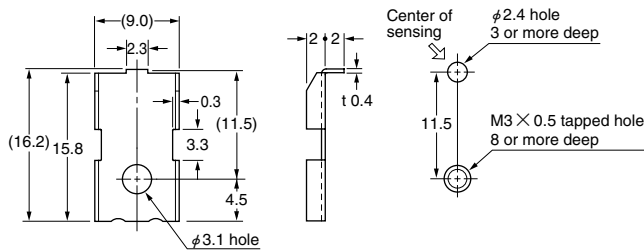

Material: Cold rolled carbon steel (SPCC)
(Nickel plated)

1 No. each of M3 (length 12mm) truss head screw, nut, spring washer and plain washer is attached.

MS-GXL8 Sensor mounting bracket for GXL-8F/GXL-8H type (Accessory)

Mounting hole dimensions

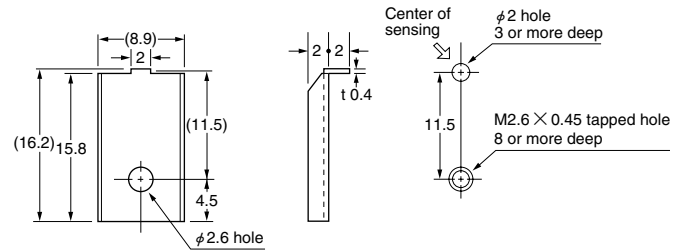

Material: Cold rolled carbon steel (SPCC)
(Nickel plated)

1 No. each of M2.6 (length 12mm) truss head screw, nut, spring washer and plain washer is attached.

MS-GXL12-1 Sensor mounting bracket for GXL-N12 type (Accessory)

Mounting hole dimensions

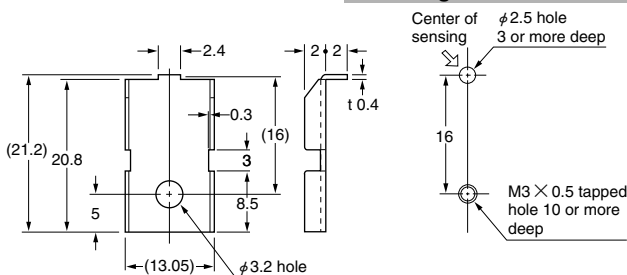

Material: Cold rolled carbon steel (SPCC)
(Nickel plated)

1 No. each of M3 (length 12mm) pan head screw, plain washer, spring washer and rubber washer (φ9.5 x 10.5mm) is attached.

MS-R1 Rubber washer for GXL-N12 type (Accessory)

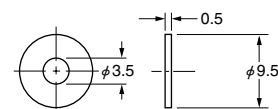

Material: NBR

GXL

DIMENSIONS (Unit: mm)

MS-GXL8-3 Sensor mounting bracket for **GXL-8F/GXL-8H** type (Optional)

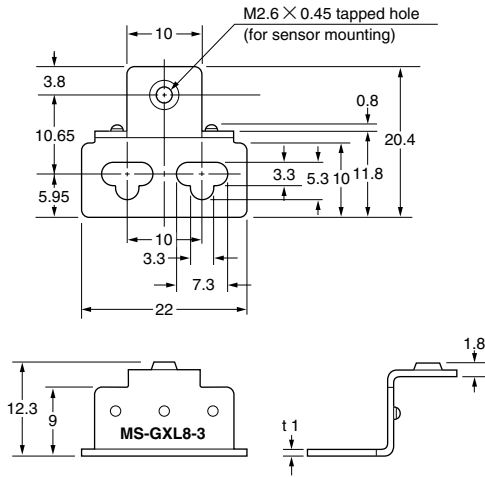

Material: Stainless steel (SUS304)

One M2.6 (length 8mm) pan head screw and two M3 (length 8mm) screws with washers are attached.

MS-GXL12-2 Sensor mounting bracket for **GXL-N12** type (Optional)

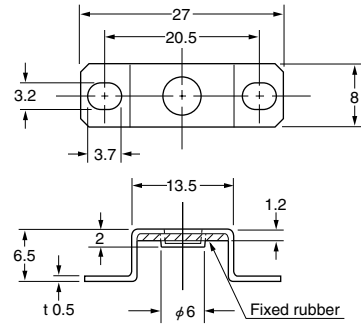

Material: Bracket ... stainless steel (SUS304)
Fixed rubber ... FKM (Fluorine rubber)

MS-GXL15 Sensor mounting bracket for **GXL-15** type (Optional)

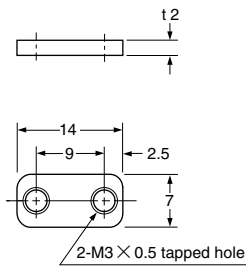

Material: Cold rolled carbon steel (SPCC)

MS-GXL15-2 Sensor mounting bracket for **GXL-15F** type (Optional)

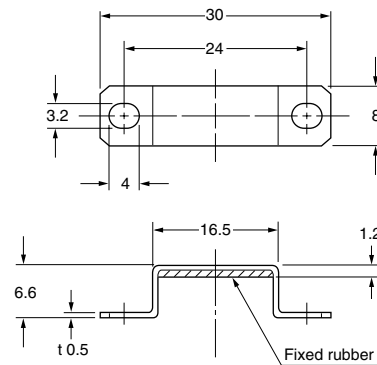

Material: Bracket ... stainless steel (SUS304)
Fixed rubber ... FKM (Fluorine rubber)

CN-13 Connector for terminal type (Optional)

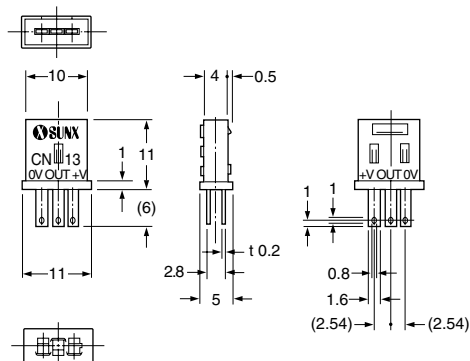

MS-A15F
MS-A15H Aluminum sheet
(Accessory for **GXL-15FLU**, **GXL-15HLU** and **GXL-15HL** type)

