

# GA-10 SERIES GH SERIES

## Amplifier-separated Micro-size Inductive Proximity Sensor

GXL

GL-6

GL-8U

GL-N12

GL-18H/18HL  
Amplifier Built-in Type

GX-U

GX-N

GX

GA-10/GH  
Amplifier-separated Type

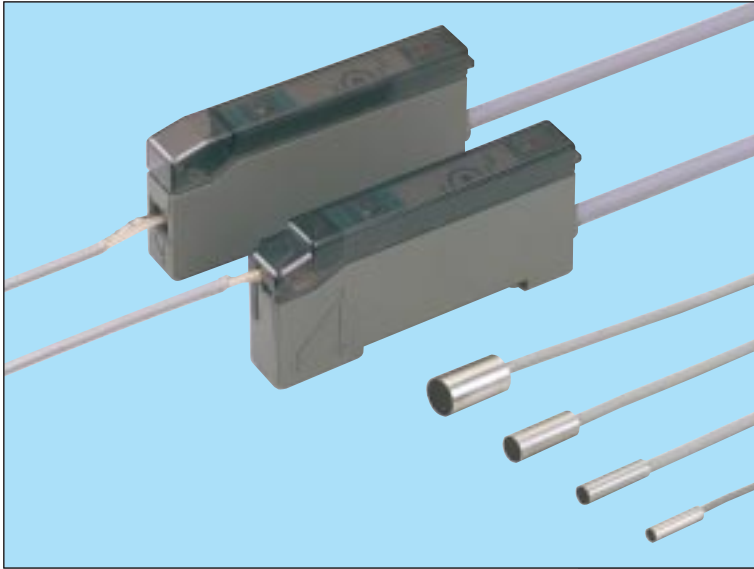

### High Accuracy Sensing with a Slim-size Sensor

#### Slim & Small

The amplifier is extremely slim, just 10mm thick. This results in a compact size even if several amplifiers are mounted in a row. Moreover, the sensor head is also extremely small, the smallest being just  $\phi 2.8\text{mm}$  (GH-2S).

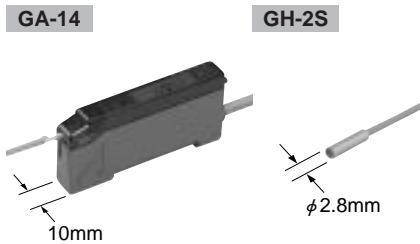

#### Reliable

The sensor heads (GH-3S, GH-5S, GH-8S and GH-F8S) have IP67 protection. Further, the tightening torque has been significantly improved due to its thick case.

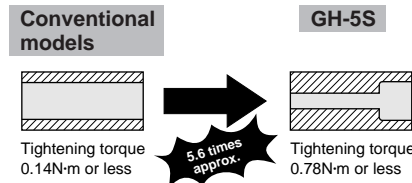

#### Accurate

Fine adjustments are possible by its 18-turn, wide adjustment range sensitivity adjuster. Besides, its repeatability is  $1\mu\text{m}$  or less and its temperature characteristics have been improved to twice as good as those of conventional models. Hence, it is suitable for high accuracy positioning applications.

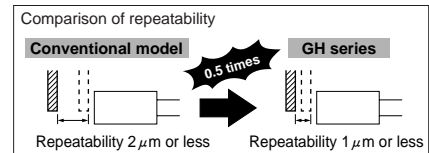
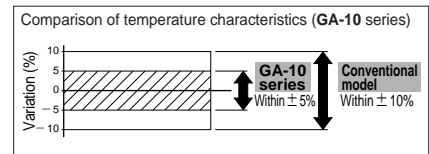

#### Screw Tightening Type Available GA-15

GA-15 enables sensor head connection by screw tightening. Moreover, since the cover of the connecting portion is transparent, it is possible to confirm whether the connection is proper.

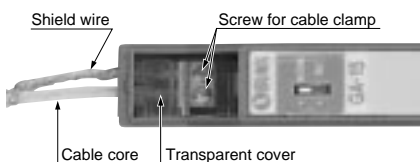

#### Disconnection Alarm Indicator

If the sensor head cable is damaged, or misconnected, the disconnection alarm indicator (orange LED) lights up for your attention.

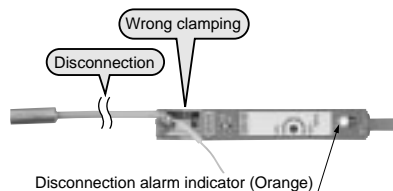

#### Wire-saving

Amplifier with a plug-in connector, which is connectable to the sensor block of an S-LINK system, or to the sensor block for simple wiring SL-BMW or SL-BW, or to a mating cable, is also available.

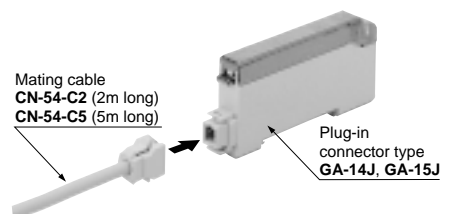

Note: The above photograph shows GA-14J.

## APPLICATIONS

### Inspecting presence of washer

The sensor detects the presence/absence of a washer by the height of the spring-loaded rod.

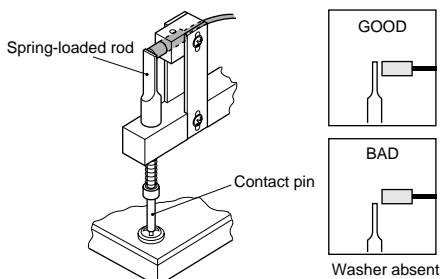

### Aligning press molds

The sensor detects even a minute misalignment.

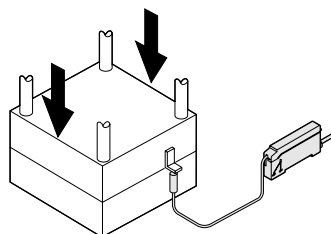

### Detecting vibration of parts-feeder

The sensor detects whether the feeder is vibrating.

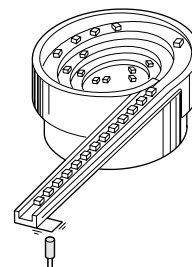

## ORDER GUIDE

### Sensor heads

Type	Appearance (mm)	Sensing range (Note)	Model No.	Hysteresis
Cylindrical type		Maximum operation distance 1.2mm Stable sensing range (0 to 0.6mm)	<b>GH-2S</b>	0.07mm or less
		1.8mm (0 to 0.8mm)	<b>GH-3S</b>	0.05mm or less
		2.4mm (0 to 1.0mm)	<b>GH-5S</b>	
	Spatter-resistant type		4.0mm (0 to 2.0mm)	<b>GH-8S</b>
<b>GH-F8S</b>				

Note: The stable sensing range represents the sensing range for which the sensor can satisfy all the given specifications with the standard sensing object.  
The maximum operation distance represents the maximum distance for which the sensor can detect the standard sensing object at +20°C constant ambient temperature.  
Usage within the stable sensing range is recommended for accurate sensing applications.

### Amplifiers

Type	Appearance	Model No.	Supply voltage	Output
One-touch clamping type		<b>GA-14</b>	12 to 24V DC ± 10%	NPN open-collector transistor
Screw tightening type		<b>GA-15</b>		

### Plug-in connector type

Plug-in connector type is available. (Standard: cable type)  
When ordering the plug-in connector type, add suffix 'J' to the model No.  
Model No.: **GA-14J**, **GA-15J**

Usable with the sensor & wire-saving link system **S-LINK**, sensor block for simple wiring **SL-BMW** or **SL-BW**, or with connector attached cable **CN-54-C2** or **CN-54-C5**.

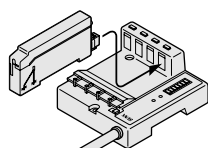

Sensor & wire-saving link system **S-LINK**

(Refer to P.26~ for details.)

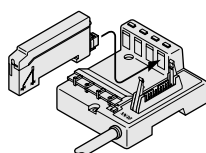

Sensor block for simple wiring **SL-BMW**, **SL-BW**

(Refer to P.54~ for details.)

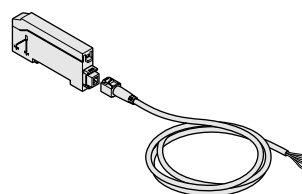

Connector attached cable

**CN-54-C2** (2m long)  
**CN-54-C5** (5m long)

## OPTIONS

Designation	Model No.	Description
Sensor head mounting bracket	<b>MS-SS3</b>	Mounting bracket for <b>GH-3S</b>
	<b>MS-SS5</b>	Mounting bracket for <b>GH-5S</b>
	<b>MS-SS8</b>	Mounting bracket for <b>GH-8S</b>

## Sensor head mounting bracket

The sensor head can be easily fixed.

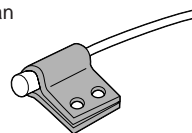

## SPECIFICATIONS

## Amplifiers

Type		One-touch clamping type	Screw tightening type
Item	Model No.	<b>GA-14</b>	<b>GA-15</b>
Applicable sensor head		GH series	
Supply voltage		12 to 24V DC $\pm$ 10% Ripple P-P 10% or less	
Current consumption		25mA or less	
Sensing output		NPN open-collector transistor <ul style="list-style-type: none"> <li>• Maximum sink current: 100mA</li> <li>• Applied voltage: 30V DC or less (between sensing output and 0V)</li> <li>• Residual voltage: 1V or less (at 100mA sink current) 0.4V or less (at 16mA sink current)</li> </ul>	
Output operation		Switchable either Normally Open or Normally Closed	
Short-circuit protection		Incorporated	
Disconnection alarm output		NPN open-collector transistor <ul style="list-style-type: none"> <li>• Maximum sink current: 100mA</li> <li>• Applied voltage: 30V DC or less (between disconnection alarm output and 0V)</li> <li>• Residual voltage: 1V or less (at 100mA sink current) 0.4V or less (at 16mA sink current)</li> </ul>	
Output operation		ON when the sensor head cable is disconnected or misconnected	
Short-circuit protection		Incorporated	
Max. response frequency		3.3kHz	
Operation indicator		Red LED (lights up when the sensing output is ON)	
Disconnection alarm indicator		Orange LED (lights up when the disconnection alarm output is ON)	
Sensitivity adjuster		18-turn potentiometer	
Environmental resistance	Ambient temperature	- 10 to + 60°C (No dew condensation or icing allowed), Storage : - 20 to + 70°C	
	Ambient humidity	35 to 85% RH, Storage: 35 to 85% RH	
	Noise immunity	Power line: 240Vp, 10ms cycle and 0.5 $\mu$ s pulse width; Radiation: 300Vp, 10ms cycle and 0.5 $\mu$ s pulse width (with noise simulator)	
	Voltage withstandability	1,000V AC for one min. between all supply terminals connected together and enclosure	
	Insulation resistance	20M $\Omega$ , or more, with 250V DC megger between all supply terminals connected together and enclosure	
	Vibration resistance	10 to 150Hz frequency, 0.75mm amplitude in X, Y and Z directions for two hours each	
Shock resistance	100m/s <sup>2</sup> acceleration (10G approx.) in X, Y and Z directions for five times each		
Temperature characteristics (Note)		Within $\pm$ 5%	
Material		Enclosure: Heat-resistant ABS, Cover: Polycarbonate, Cable lock lever: PPS ( <b>GA-14</b> only)	
Cable		0.02mm <sup>2</sup> 4-core cabtyre cable, 2m long	
Cable extension		Extension up to total 100m is possible with 0.3mm <sup>2</sup> , or more, cable.	
Weight		65g approx.	
Accessories		<b>MS-DIN-2</b> (Amplifier mounting bracket): 1 No., Adjusting screwdriver: 1 No.	

Note: The value of the temperature characteristics gives the variation in the operation distance, that has been set within the stable sensing range at 20°C, for an ambient temperature drift from 0 to + 55°C.

## SPECIFICATIONS

### Sensor heads

Item	Type	Cylindrical type				Spatter-resistant type
	Model No.	GH-2S	GH-3S	GH-5S	GH-8S	GH-F8S
Applicable amplifier		GA-10 series				
Stable sensing range (Note 1)		0 to 0.6mm	0 to 0.8mm	0 to 1.0mm	0 to 2.0mm	
Max. operation distance (Note 1)		1.2mm	1.8mm	2.4mm	4.0mm	
Standard sensing object		Iron sheet 5 × 5 × t1mm			Iron sheet 10 × 10 × t1mm	
Hysteresis (Note 2)		0.07mm or less	0.05mm or less		0.04mm or less	
Repeatability (Note 2)		Along sensing axis, perpendicular to sensing axis: 1 μm or less				
Environmental resistance	Protection	IP50 (IEC)	IP67 (IEC), IP67g (JEM)			
	Ambient temperature	- 10 to + 60°C, Storage: - 20 to + 70°C				
	Ambient humidity	35 to 85% RH, Storage: 35 to 85% RH				
	Vibration resistance	10 to 55Hz frequency, 1.5mm amplitude in X, Y and Z directions for two hours each				
	Shock resistance	500m/s <sup>2</sup> acceleration (50G approx.) in X, Y and Z directions for five times each				
Temperature characteristics (Note 3)		Within ± 7%	Within ± 5%	Within ± 4%		
Material		Enclosure: Stainless steel (SUS303) Sensing face: PVC	Enclosure: Stainless steel (SUS303) Sensing face: ABS	Enclosure: Stainless steel (SUS303) Sensing face: PAR	Enclosure: Stainless steel (SUS303) Sensing face: ABS	Enclosure: Stainless steel (SUS303) Sensing face: Fluorine resin
Cable		Oil resistant high-frequency coaxial cable, 3m long (Note 4)				Spatter resistant cable (cable sheath: fluorine resin), 3m long
Weight		15g approx.	30g approx.		40g approx.	55g approx.

- Notes: 1) The stable sensing range represents the sensing range for which the sensor can satisfy all the given specifications with the standard sensing object. The maximum operation distance represents the maximum distance for which the sensor can detect the standard sensing object at +20°C constant ambient temperature. Usage within the stable sensing range is recommended for accurate sensing applications.  
 2) Value is given for the stable sensing range.  
 3) The value represents the variation in the operation distance, that has been set within the stable sensing range at 20°C, for an ambient temperature drift from 0 to +55°C.  
 4) The length of the sensor head cable cannot be changed.

## I/O CIRCUIT AND WIRING DIAGRAMS

### I/O circuit diagram

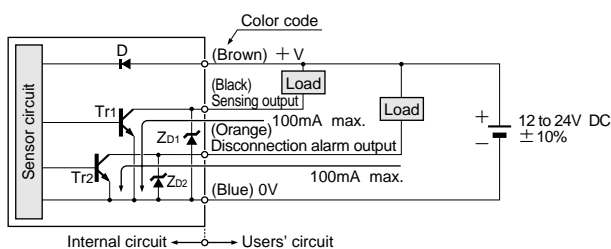

Symbols ... D: Reverse supply polarity protection diode  
 Zd1, Zd2: Surge absorption zener diode  
 Tr1, Tr2: NPN output transistor

### Wiring diagram

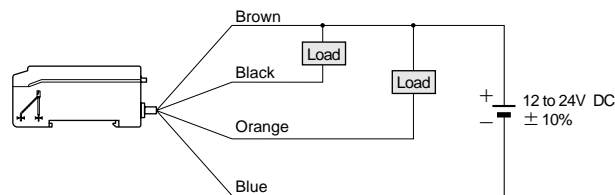

### Pin position of plug-in connector type (GA-14J, GA-15J)

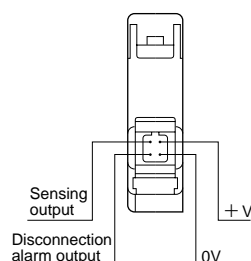

GXL

GL-6

GL-8U

Amplifier Built-in Type

GL-18H/18HL

GX-U

GX-N

GX

Amplifier-separated Type

GA-10/GH

# GA-10/GH

## SENSING CHARACTERISTICS (TYPICAL)

### GH-2S

#### Sensing field

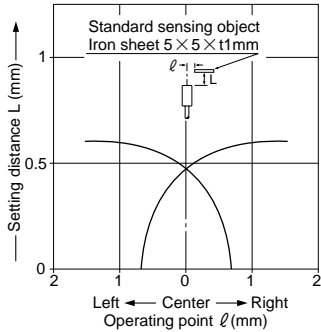

The graph on the left is plotted with the sensitivity adjusted so as to just detect a  $5 \times 5 \times 1$ mm iron sheet placed at a distance of 0.6mm.

#### Correlation between sensing object size and sensing range

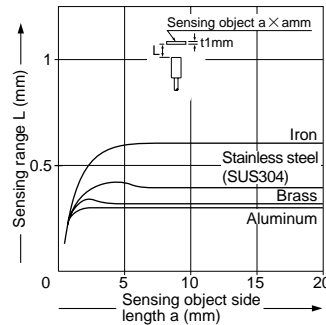

As the sensing object size becomes smaller than the standard size (iron sheet  $5 \times 5 \times 1$ mm), the sensing range shortens as shown in the left figure.

(The graph on the left is plotted with the sensitivity adjusted so as to just detect a  $5 \times 5 \times 1$ mm iron sheet placed at a distance of 0.6mm.)

### GH-3S

#### Sensing field

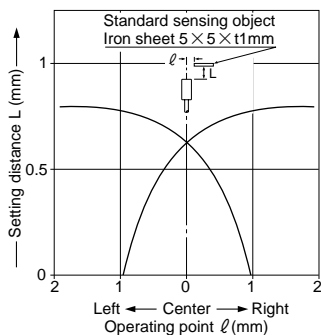

The graph on the left is plotted with the sensitivity adjusted so as to just detect a  $5 \times 5 \times 1$ mm iron sheet placed at a distance of 0.8mm.

#### Correlation between sensing object size and sensing range

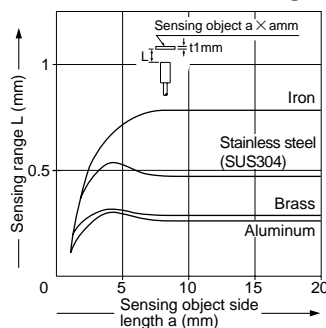

As the sensing object size becomes smaller than the standard size (iron sheet  $5 \times 5 \times 1$ mm), the sensing range shortens as shown in the left figure.

(The graph on the left is plotted with the sensitivity adjusted so as to just detect a  $5 \times 5 \times 1$ mm iron sheet placed at a distance of 0.8mm.)

### GH-5S

#### Sensing field

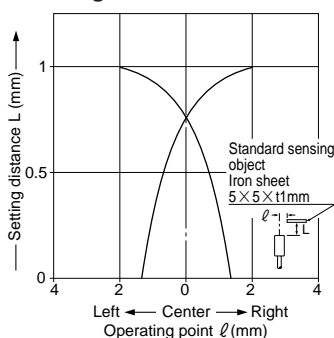

The graph on the left is plotted with the sensitivity adjusted so as to just detect a  $5 \times 5 \times 1$ mm iron sheet placed at a distance of 1.0mm.

#### Correlation between sensing object size and sensing range

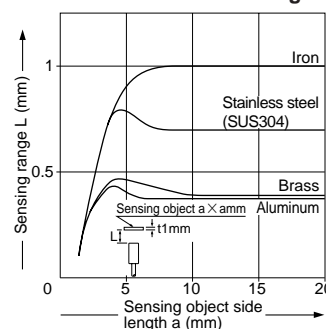

As the sensing object size becomes smaller than the standard size (iron sheet  $5 \times 5 \times 1$ mm), the sensing range shortens as shown in the left figure.

(The graph on the left is plotted with the sensitivity adjusted so as to just detect a  $5 \times 5 \times 1$ mm iron sheet placed at a distance of 1.0mm.)

### GH-8S GH-F8S

#### Sensing field

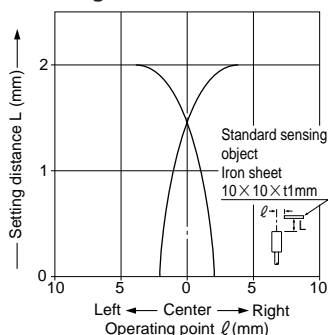

The graph on the left is plotted with the sensitivity adjusted so as to just detect a  $10 \times 10 \times 1$ mm iron sheet placed at a distance of 2.0mm.

#### Correlation between sensing object size and sensing range

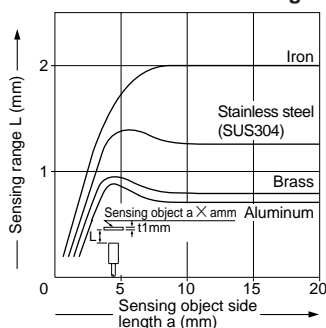

As the sensing object size becomes smaller than the standard size (iron sheet  $10 \times 10 \times 1$ mm), the sensing range shortens as shown in the left figure.

(The graph on the left is plotted with the sensitivity adjusted so as to just detect a  $10 \times 10 \times 1$ mm iron sheet placed at a distance of 2.0mm.)

## PRECAUTIONS FOR PROPER USE

Refer to P.836~ for general precautions.



This product is not a safety sensor. Its use is not intended or designed to protect life and prevent body injury or property damage from dangerous parts of machinery. It is a normal object detection sensor.

### Mounting of the amplifier

- Make sure to connect the **GH** sensor head to the **GA-10** amplifier correctly, or malfunction will occur.
- Do not shorten or lengthen the sensor head cable.

#### How to mount the amplifier

- ① Fit the rear part of the amplifier on the attached amplifier mounting bracket (**MS-DIN-2**) or a 35mm width DIN rail.
- ② Press down the front part of the amplifier on the attached amplifier mounting bracket (**MS-DIN-2**) or DIN rail to fit it.

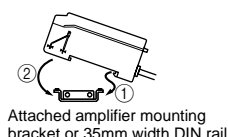

#### How to remove the amplifier

- ① Push the amplifier forward.
- ② Lift up the front part of the amplifier to remove it.

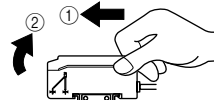

Note: Please take care that if the front part is lifted without pushing the amplifier forwards, the hooks on the rear portion of the mounting section are likely to break.

### Sensor head cable connection

#### GA-14□

- ① Prepare the cable end as shown in the right figure, and twist the shield wire and the cable core inner conductor, respectively. If they are not twisted properly, they may not enter the inlets resulting in mis-connection.

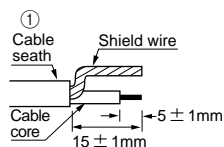

Note: Separate the shield wire from the cable core.

- ② Open the cover.

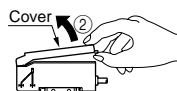

- ③ Flip the cable lock lever down.
- ④ Referring to the cable connection diagram at the side of the amplifier, insert the shield wire and the cable core straight into the inlets, without bending them.

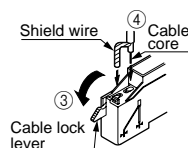

- ⑤ Flip up the cable lock lever to lock the cable.

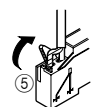

- ⑥ Make sure to fit the cover on the amplifier after connecting the sensor head.

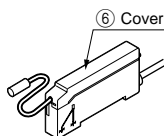

Note: If there is a shred of the cable left inside the cable inlet, remove it before connecting the sensor head cables. Turn the amplifier upside down, and tap it around the holes. If the shred still remains, peel the bottom seal off the amplifier, and drop it out. (The seal is reusable.)

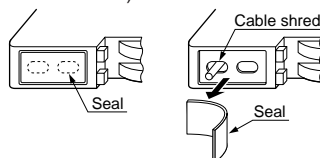

#### GA-15□

- ① Prepare the cable end as shown in the right figure, and twist the shield wire and the cable core inner conductor, respectively.

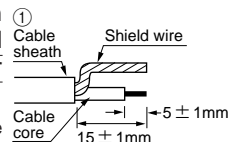

Note: Separate the shield wire from the cable core.

- ② Open the cover.

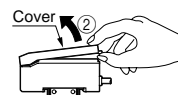

- ③ Loosen the screw for the cable clamp by turning it counterclockwise.

- ④ Referring to the cable connection diagram at the side of the amplifier, insert the shield wire and the cable core straight into the inlets, without bending them.

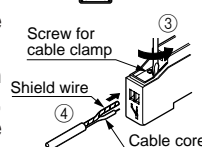

- ⑤ Tighten the screw for the cable clamp by turning it clockwise. The tightening torque should be 0.15N·m or less.

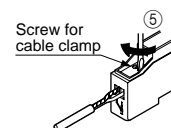

- ⑥ Make sure to fit the cover on the amplifier after connecting the sensor head.

Note: Take care since the shield wire may get slightly exposed.

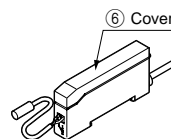

### Mounting of the sensor head

#### How to mount the sensor head

- The tightening torque should be as given below. Make sure to use a set screw with a cup-point end.

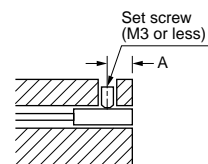

Model No.	Tightening torque	A (mm)
GH-2S	0.17N·m	3 or more
GH-3S	0.17N·m	4 or more
GH-5S	0.78N·m	5 or more
GH-8S GH-F8S	0.59N·m	5 or more

Note: Do not tighten excessively.

#### Distance from surrounding metal

- If there is a metal near the sensor head, it may affect the sensing performance. Keep the minimum distance specified in the table below.

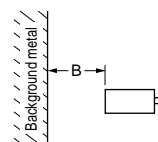

Model No.	B (mm)
GH-2S	3
GH-3S	4
GH-5S	5
GH-8S GH-F8S	9

# GA-10/GH

## PRECAUTIONS FOR PROPER USE

Refer to P.836~for general precautions.

### Mutual interference

- When two or more sensors are installed in parallel or face to face, keep the minimum separation distance specified below to avoid mutual interference.

<Face to face mounting> <Parallel mounting>

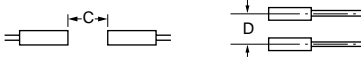

Model No.	C (mm)	D (mm)
GH-2S	15	10
GH-3S	20	15
GH-5S	25	20
GH-8S GH-F8S	40	26

### Sensing range

- The sensing range is specified for the standard sensing object. With a non-ferrous metal, the sensing range is obtained by multiplying with the correction coefficient specified below.

### Correction coefficient

Model No.	GH-2S	GH-3S	GH-5S	GH-8S GH-F8S
Metal				
Iron	1	1	1	1
Stainless steel (SUS304)	0.68 approx.	0.55 approx.	0.69 approx.	0.64 approx.
Brass	0.53 approx.	0.35 approx.	0.41 approx.	0.37 approx.
Aluminum	0.51 approx.	0.33 approx.	0.39 approx.	0.32 approx.

### Part description

#### GA-14

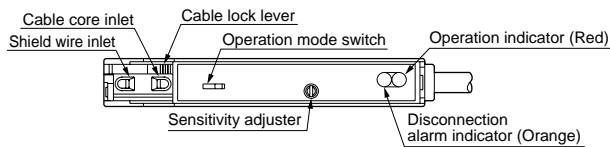

#### GA-15

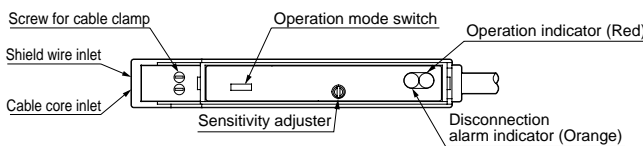

### Sensitivity adjustment

Step	Sensing condition	Adjustment	Sensitivity adjuster
①	Set the operation mode switch to NORM. (Initial setting)	• Turn the sensitivity adjuster fully counterclockwise. (Minimum sensitivity)	
②	Approach along sensing axis 	• Place the sensing object within the stable sensing range. • Turn the sensitivity adjuster clockwise and set it at the point (A) where the operation indicator lights up.	
	Approach perpendicular to sensing axis 	• Place the sensing object within the stable sensing range. • Turn the sensitivity adjuster clockwise, and set it at the optimum sensing point (B) which is a little beyond the point (A) where the operation indicator lights up.	
③	Select the operation mode as per your application. (NORM.: Normally open, INV: Normally closed)		

Note: Use the accessory screwdriver to turn the adjuster slowly. Turning with excessive strength will cause damage to the adjuster.

### Others

- Do not use during the initial transient time (500ms) after the power supply is switched on.
- Do not use the sensor at places having intense vibrations, as this can cause malfunction.
- When the sensor head is mounted on a moving base, stress should not be applied to the sensor cable joint.

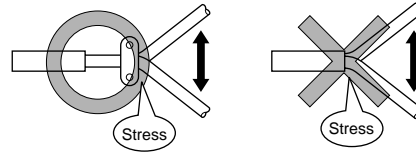

## DIMENSIONS (Unit: mm)

### GA-14 Amplifier

Assembly dimensions with attached amplifier mounting bracket

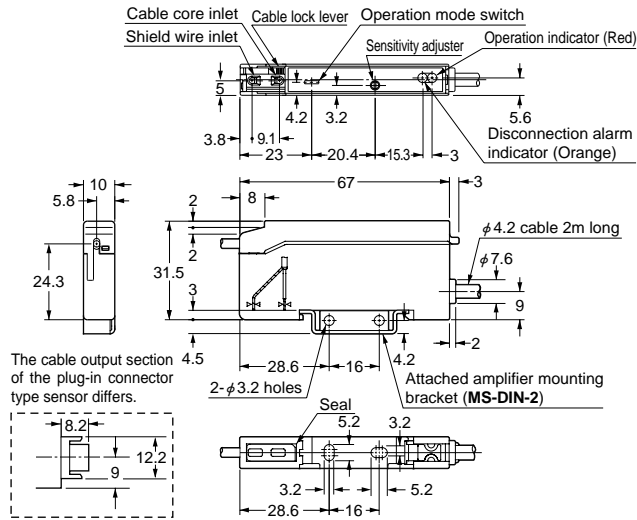

Note: The top view is without the cable and the cover.

### GA-15 Amplifier

Assembly dimensions with attached amplifier mounting bracket

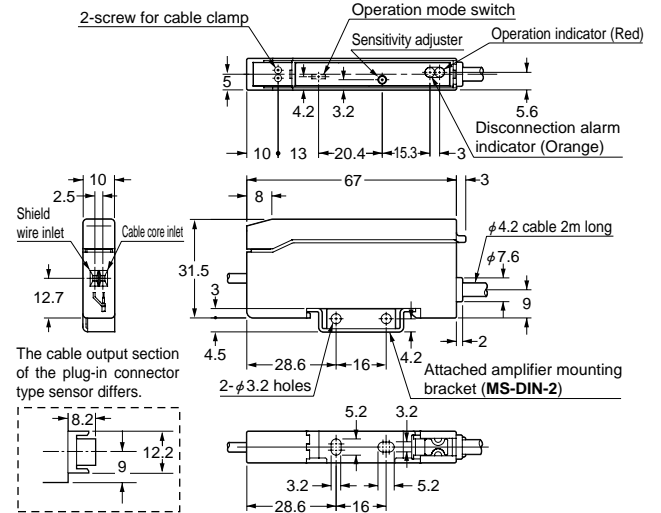

Note: The top view is without the cable and the cover.

### MS-DIN-2 Amplifier mounting bracket (Accessory for amplifier)

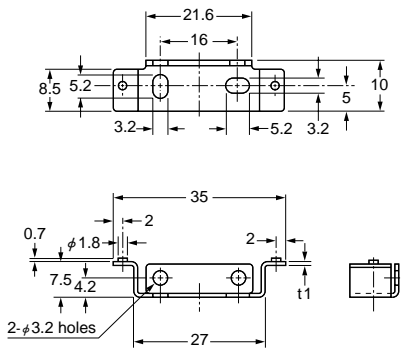

Material: Cold rolled carbon steel (SPCC)  
(Uni-chrome plated)

### MS-SS3 MS-SS5 MS-SS8 Sensor head mounting bracket (Optional)

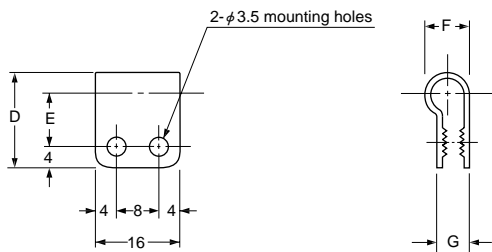

Material: Nylon 66

### GH-2S GH-3S GH-5S GH-8S GH-F8S Sensor head

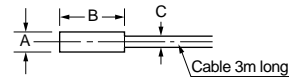

Model No.	A	B	C
GH-2S	φ2.8	12	φ1.6
GH-3S	φ3.8	15	φ2.5
GH-5S	φ5.4	15	φ2.5
GH-8S GH-F8S	φ8.0	15	φ2.5

Symbol	Model No.	MS-SS3	MS-SS5	MS-SS8
D		16	18	20
E		9	10	11
F		6.3	8.3	10.3
G		4.9	6.1	6.5
Applicable sensor head model No.		GH-3S	GH-5S	GH-8S

GXL

GL-6

GL-8U

Amplifier Built-in Type

GL-18H/18HL

GX-U

GX-N

GX

Amplifier-separated Type  
GA-10/GH