



COMPACT · ADJUSTABLE RANGE REFLECTIVE PHOTOELECTRIC SENSOR **Amplifier Built-in**

New

CX-440 SERIES



Hysteresis 2 % & Difference in sensing range between white and black 1 %

Ultra high-precision reflective sensor can even detect differences in individual namecards!



The CX-440 series, with a new advanced optical system

Excellent stability in detecting height differences of as small as 0.4 mm 0.016 in and object of different colors

High precision

Can sense differences of as small as 0.4 mm 0.016 in, with hysteresis of 2 % or less

2.5 times better than before

An advanced optical system provides sensing performance that is approx. 2.5 times that of conventional models (CX-441 short sensing range type)(Approx. 4 times for CX-442 long sensing range type). Even ultra-small differences of 0.4 mm 0.016 in can be detected accurately. (When distance is set to 20 mm 0.787 in)

(Hysteresis for CX-441 short sensing range type: 2 % or less of sensing range)
 (Hysteresis for CX-442 long sensing range type: 5 % or less of sensing range)

Not affected by color

※The difference in sensing range between white and black is 1 % or less.

1.3 times better than before

Sensing performance for difference in sensing range between white and black has been improved by about 30 % compared to previous models. Both white and black objects can be sensed at the same distances.

(Difference between white and black for CX-441 short sensing range type: 1 % or less of sensing range)
 (Difference between white and black for CX-442 long sensing range type: 3 % or less of sensing range)

No adjuster control is needed, even when products of different colors are moving along the production line.

※The difference in sensing range between white non-glossy paper and black non-glossy paper (lightness: 5)

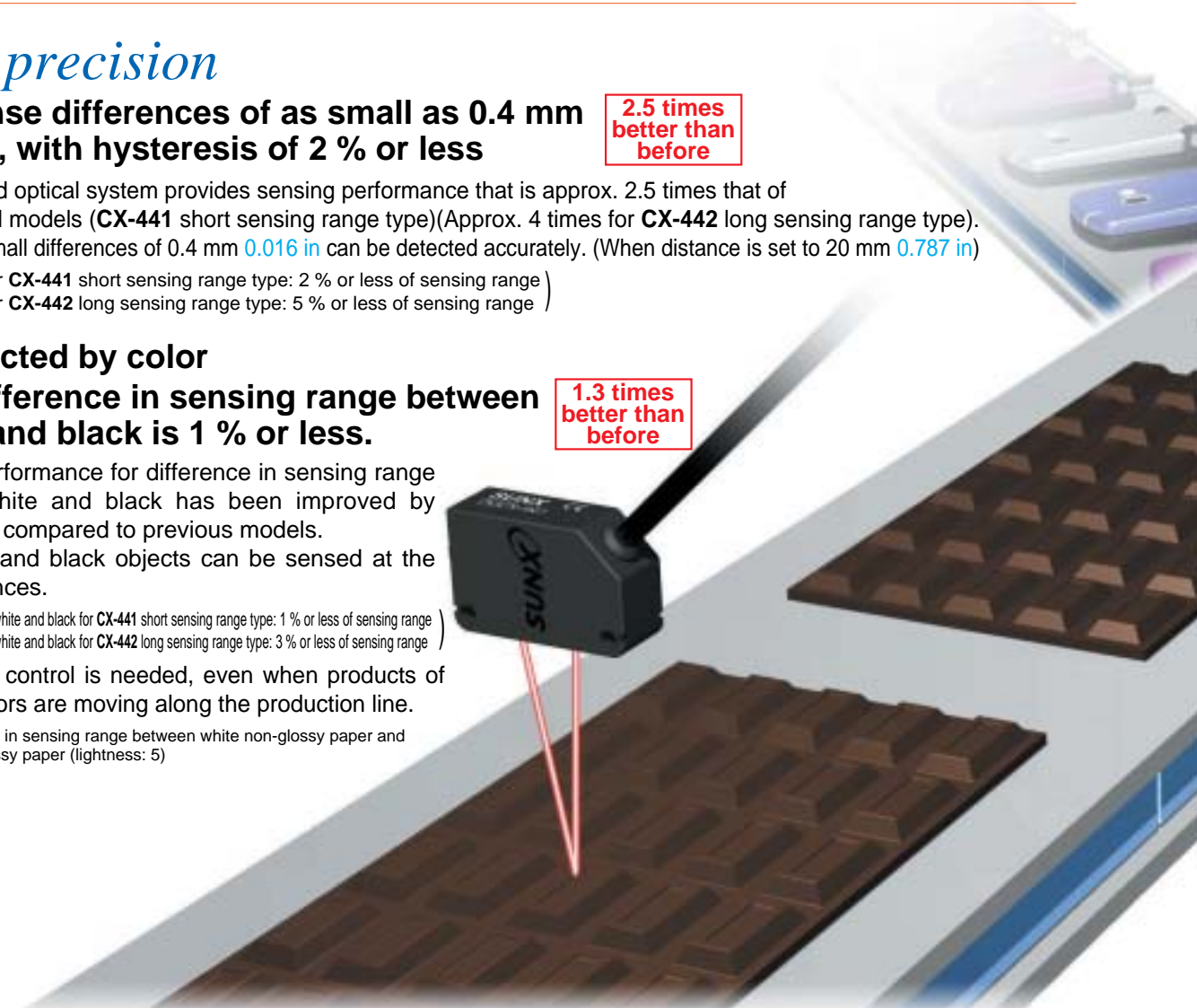

Can be used for sensing minute differences

Equipped with a 5-turn adjuster, so that even severe range settings can be handled with ease.



Easy positioning of sensing objects

A red LED spot that is easily visible allows the sensing position to be checked visually, so that positioning during setup can be done easily.

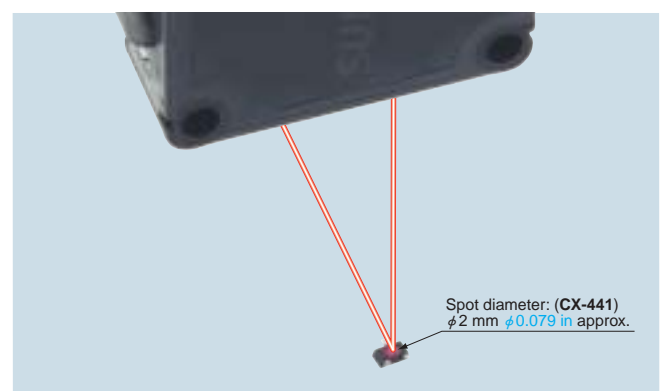

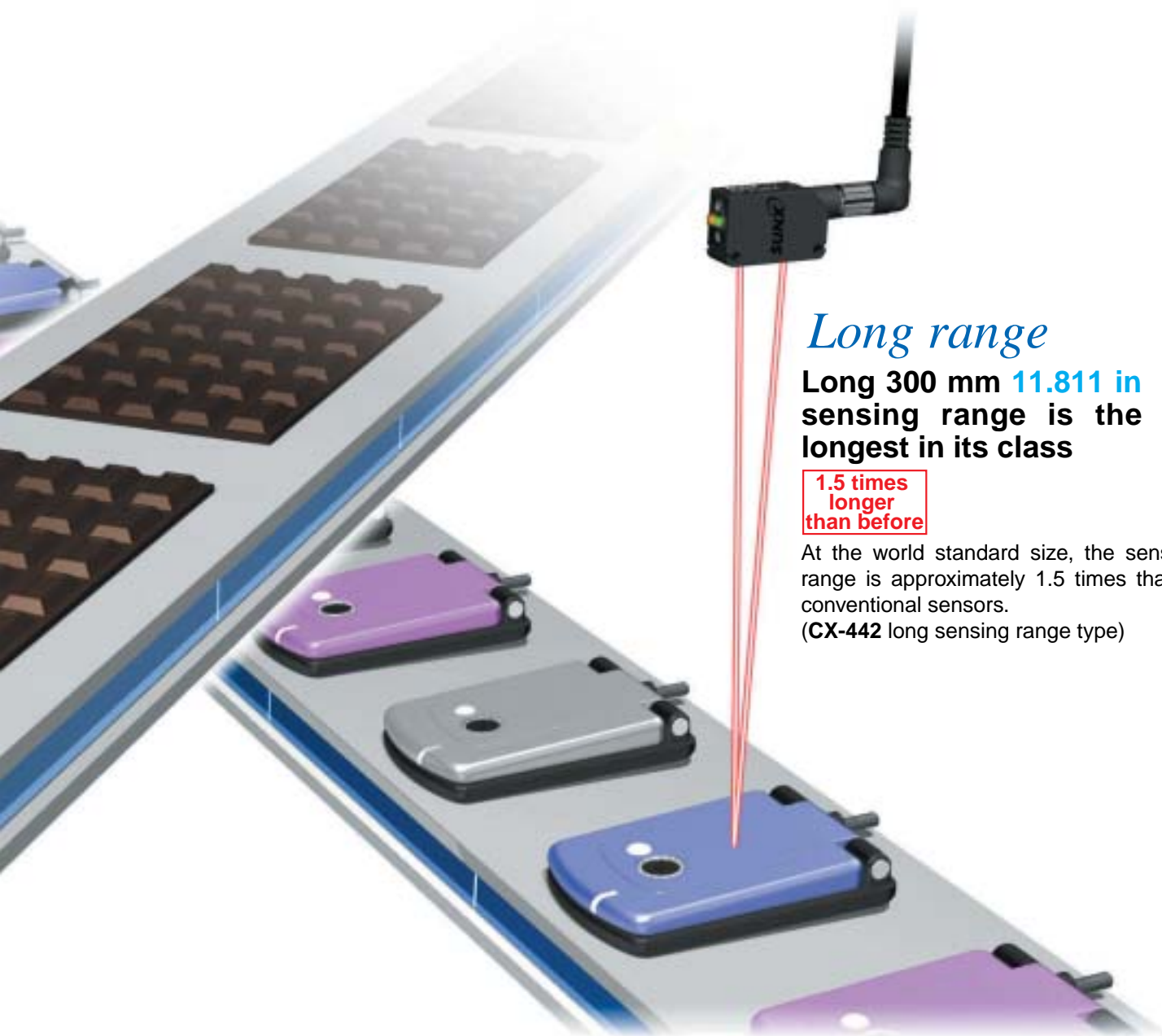

Long range

Long 300 mm **11.811 in** sensing range is the longest in its class

1.5 times longer than before

At the world standard size, the sensing range is approximately 1.5 times that of conventional sensors.

(CX-442 long sensing range type)

Compact size

The sensors are compact in size at W11.2 × H31 × D20 mm **W0.441 × H1.220 × D0.787 in.**

The mounting pitch is also at the world standard size of 25.4 mm **1.000 in.**

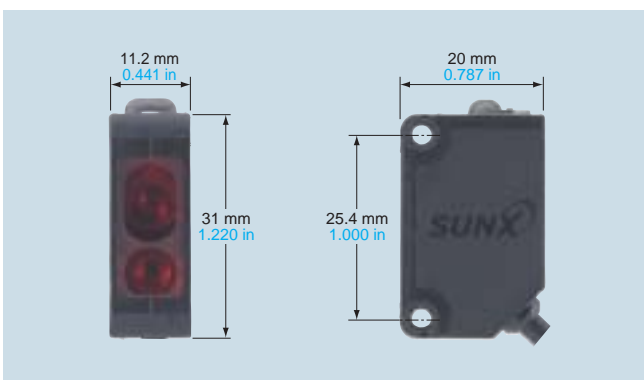

Full lineup in the CX-400 series

A full range of models is available in the **CX-400** compact beam sensor series, including thru-beam types, retroreflective types with polarizing filters and diffuse reflective types. A variety of applications are possible together with the **CX-440** series.

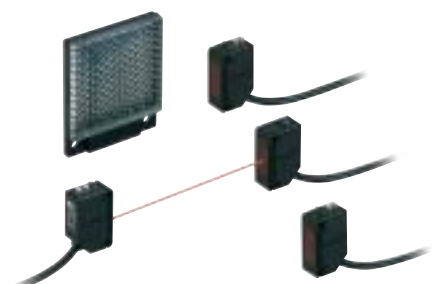

FGS / BGS functions make even severe settings possible!

Refer to 'BGS / FGS functions' (p.9) of 'PRECAUTION FOR PROPER USE' for details on the operation of the FGS / BGS functions.

The FGS function is ideal to use in the following cases

FGS

FGS (Foreground suppression) function

The sensor judges that an object is present when no light is received at position B of the light-receiving element (2-segment element).

Accordingly, even object that are glossy can be sensed. This is useful if the object and background are close together, or of the object being sensed is glossy.

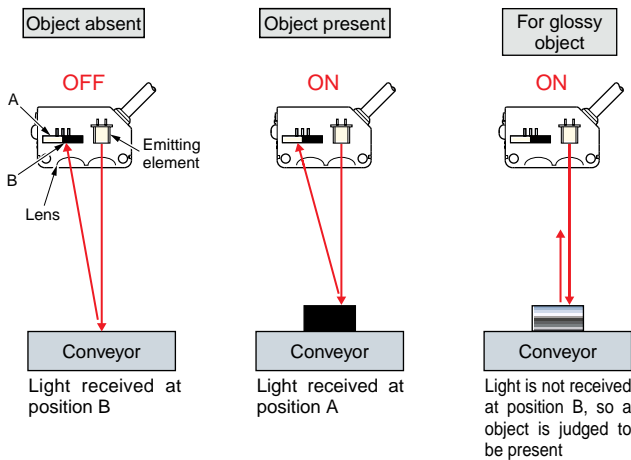

When the object and the background are close together



Distance adjustment method

Set so that the sensor turns just OFF when object is absent while the operation mode switch is set to 'Detection-OFF' (D side)



Turns ON when there is a object on the conveyor



The BGS function is ideal to use in the following cases

BGS

BGS (Background suppression) function

The sensor judges that an object is present when light is received at position A of the light-receiving element (2-segment element).

This is useful if the object and background are far apart.

The distance adjustment method is the same as the conventional adjustment method for adjustable range reflective type sensors.

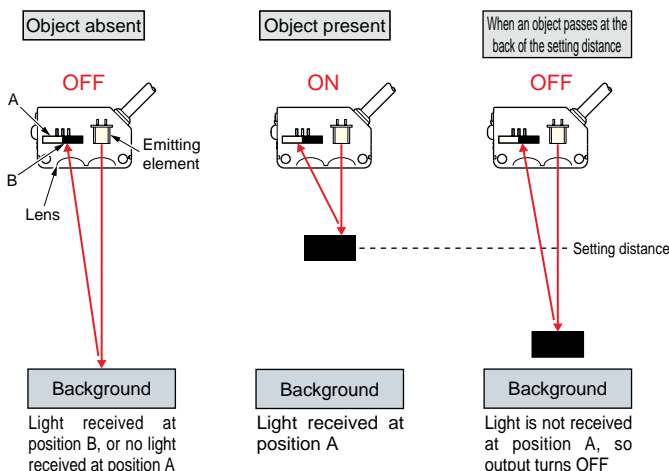

When object and the background are separated



Distance adjustment method

Set so that the sensor turns ON when an object is present while the operation mode switch is set to 'Detection-ON' (L side)



Not affected if background color changes or someone passes behind the conveyor



APPLICATIONS

Sensing sweets on a conveyor

Even objects such as thin chocolates or biscuits can be sensed stably without being affected by the conveyor.



Sensing objects on nearby lines

Stable sensing is obtained even when two production lines are in close proximity.



Senses two thin objects overlapping

Two overlapping thin objects can be sensed regardless of the material or color.



ORDER GUIDE

Type	Appearance	Adjustable range (Note)	Model No.	Output
Short sensing range		20 to 50 mm 0.787 to 1.969 in	CX-441	NPN open-collector transistor
			CX-441-P	PNP open-collector transistor
Long sensing range		40 to 300 mm 1.575 to 11.811 in	CX-442	NPN open-collector transistor
			CX-442-P	PNP open-collector transistor

NOTE: Mounting bracket is not supplied with the sensor. Please select from the range of optional sensor mounting brackets.

Note: The adjustable range stands for the maximum sensing range which can be set with the distance adjuster. The sensor can detect an object 2 mm 0.079 in [CX-442(-P)]: 20 mm 0.787 in], or more, away.

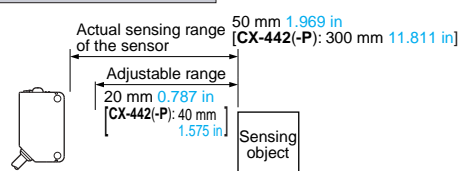

Plug-in connector type

Plug-in connector type (Standard: cable type) is also available.

Type	Standard	Plug-in connector type (Note)
NPN output	CX-441	CX-441-Z
	CX-442	CX-442-Z
PNP output	CX-441-P	CX-441-P-Z
	CX-442-P	CX-442-P-Z

Note: Please order the suitable mating cable separately for plug-in connector type.

• Mating cables

Type	Model No.	Description
Straight	CN-24A-C2	Length: 2 m 6.562 ft
	CN-24A-C5	Length: 5 m 16.404 ft
Elbow	CN-24AL-C2	Length: 2 m 6.562 ft
	CN-24AL-C5	Length: 5 m 16.404 ft

0.2 mm² 4-core cabtyre cable with connector on one end
Cable outer diameter: ϕ 4 mm ϕ 0.157 in

• CN-24A-C2, CN-24A-C5

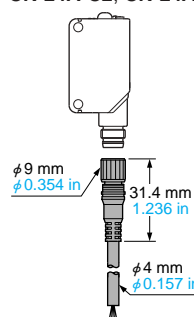

• CN-24AL-C2, CN-24AL-C5

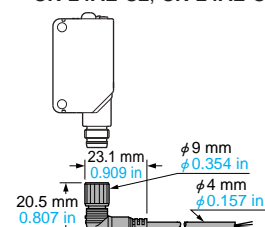

ORDER GUIDE

CX-400 series lineup

Type	Appearance	Sensing range	Model No.	Output	Emitting element
Thru-beam			CX-411	NPN open-collector transistor	Red LED
			CX-411-P	PNP open-collector transistor	
Retroreflective with polarizing filters			CX-491	NPN open-collector transistor	
			CX-491-P	PNP open-collector transistor	
Diffuse reflective			CX-421	NPN open-collector transistor	Infrared LED
			CX-421-P	PNP open-collector transistor	
			CX-422	NPN open-collector transistor	
			CX-422-P	PNP open-collector transistor	
Narrow-view reflective			CX-423	NPN open-collector transistor	Red LED
			CX-423-P	PNP open-collector transistor	

OPTIONS

Designation	Model No.	Description	
Sensor mounting bracket (Note)	MS-CX2-1	Foot angled mounting bracket	
	MS-CX2-2	Foot biangled mounting bracket	
	MS-CX2-4	Protective mounting bracket	
	MS-CX2-5	Back biangled mounting bracket	
	MS-CX-3	Back angled mounting bracket	
Universal sensor mounting stand	MS-AJ1	Horizontal mounting type	Basic assembly
	MS-AJ2	Vertical mounting type	
	MS-AJ1-A	Horizontal mounting type	Lateral arm assembly
	MS-AJ2-A	Vertical mounting type	

Note: The plug-in connector type sensor does not allow use of some sensor mounting brackets because of the protrusion of the connector.

Sensor mounting bracket

• MS-CX2-1

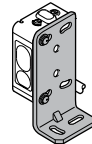

Two M3 (length 12 mm 0.472 in) screws with washers are attached.

• MS-CX2-2

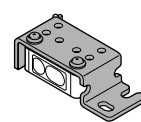

Two M3 (length 12 mm 0.472 in) screws with washers are attached.

• MS-CX2-4

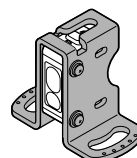

Two M3 (length 14 mm 0.551 in) screws with washers are attached.

• MS-CX2-5

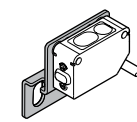

Two M3 (length 12 mm 0.472 in) screws with washers are attached.

• MS-CX-3

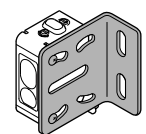

Two M3 (length 12 mm 0.472 in) screws with washers are attached.

Universal sensor mounting stand

• MS-AJ1

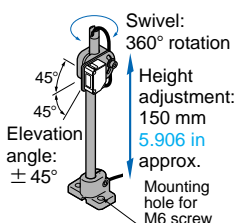

• MS-AJ1-A

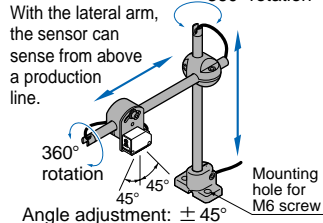

• MS-AJ2

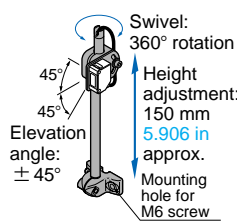

• MS-AJ2-A

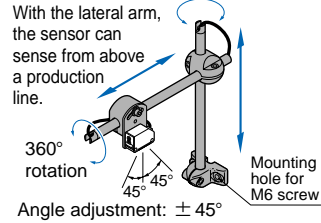

SPECIFICATIONS

Item	Type Model No.	Adjustable range reflective			
		NPN output		PNP output	
		CX-441	CX-442	CX-441-P	CX-442-P
Adjustable range (Note 1)		20 to 50 mm 0.787 to 1.969 in	40 to 300 mm 1.575 to 11.811 in	20 to 50 mm 0.787 to 1.969 in	40 to 300 mm 1.575 to 11.811 in
Sensing range (with white non-glossy paper at max. adjustment)		2 to 50 mm 0.079 to 1.969 in	20 to 300 mm 0.787 to 11.811 in	2 to 50 mm 0.079 to 1.969 in	20 to 300 mm 0.787 to 11.811 in
Hysteresis		2 % or less of operation distance	5 % or less of operation distance	2 % or less of operation distance	5 % or less of operation distance
Repeatability		Along sensing axis: 1 mm 0.039 in or less, Perpendicular to sensing axis: 0.2 mm 0.008 in or less (with white non-glossy paper)			
Supply voltage		12 to 24 V DC \pm 10 % Ripple P-P 10 % or less			
Current consumption		25 mA or less			
Output		NPN open-collector transistor		PNP open-collector transistor	
		<ul style="list-style-type: none"> • Maximum sink current: 100 mA • Applied voltage: 30 V DC or less (between output and 0 V) • Residual voltage: 1 V or less (at 100 mA sink current) 0.4 V or less (at 16 mA sink current) 		<ul style="list-style-type: none"> • Maximum source current: 100 mA • Applied voltage: 30 V DC or less (between output and + V) • Residual voltage: 1 V or less (at 100 mA source current) 0.4 V or less (at 16 mA source current) 	
	Utilization category	DC-12 or DC-13			
	Output operation	Switchable either Detection-ON or Detection-OFF			
Short-circuit protection		Incorporated			
Response time		1 ms or less			
Operation indicator		Orange LED (lights up when the output is ON)			
Stability indicator		Green LED (lights up under stable operating condition) (Note 2)			
Distance adjuster		5-turn mechanical adjuster			
Sensing mode		BGS / FGS functions Switchable with wiring of sensing mode selection input			
Automatic interference prevention function (Note 3)		Incorporated			
Environmental resistance	Pollution degree	3 (Industrial environment)			
	Protection	IP67 (IEC)			
	Ambient temperature	- 20 to + 55 °C - 4 to + 131 °F (No dew condensation or icing allowed), Storage: - 25 to + 70 °C - 13 to + 158 °F			
	Ambient humidity	35 to 85 % RH, Storage: 35 to 85 % RH			
	Ambient illuminance	Sunlight: 10,000 lx at the light-receiving face, Incandescent light: 3,000 lx at the light-receiving face			
	EMC	EN 60947-5-2			
	Voltage withstandability	1,000 V AC for one min. between all supply terminals connected together and enclosure			
	Insulation resistance	20 M Ω , or more, with 250 V DC megger between all supply terminals connected together and enclosure			
	Vibration resistance	10 to 500 Hz frequency, 3 mm 0.118 in amplitude in X, Y and Z directions for two hours each			
	Shock resistance	500 m/s ² acceleration (50 G approx.) in X, Y and Z directions for three times each			
Emitting element		Red LED (modulated)			
Spot diameter		ϕ 2 mm ϕ 0.079 in approx. (at 50 mm 1.969 in sensing range)	\square 15 mm \square 0.591 in approx. (at 300 mm 11.811 in sensing range)	ϕ 2 mm ϕ 0.079 in approx. (at 50 mm 1.969 in sensing range)	\square 15 mm \square 0.591 in approx. (at 300 mm 11.811 in sensing range)
Material		Enclosure: PBT, Front cover: Polycarbonate, Display cover: Polycarbonate			
Cable		0.2 mm ² 4-core cabtyre cable, 2 m 6.562 ft long			
Cable extension		Extension up to total 100 m 328.084 ft is possible with 0.3 mm ² , or more, cable.			
Weight		55 g approx.			

Notes: 1) The adjustable range stands for the maximum sensing range which can be set with the distance adjuster. The sensor can detect an object 2 mm 0.079 in [CX-442(-P): 20 mm 0.787 in], or more, away.

2) Refer to 'Stability indicator' (p.9) of 'PRECAUTIONS FOR PROPER USE' for the details of operation indicator.

3) Note that the detection may be unstable depending on the mounting conditions or the sensing object to be used. In the state that this product is mounted, be sure to check the operation with the actual sensing object to be used.

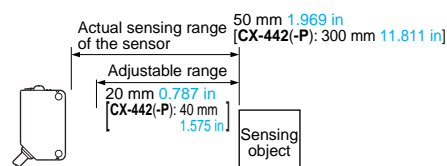

I/O CIRCUIT AND WIRING DIAGRAMS

NPN output type

I/O circuit diagram

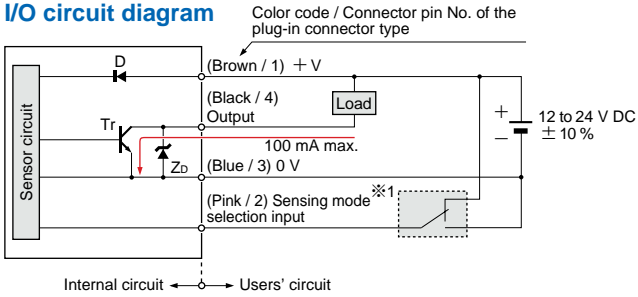

- ※1
- Sensing mode selection input
 - BGS function: Connect to 0 V
 - FGS function: Connect to +V

Symbols ... D : Reverse supply polarity protection diode
 Zd : Surge absorption zener diode
 Tr : NPN output transistor

Wiring diagram

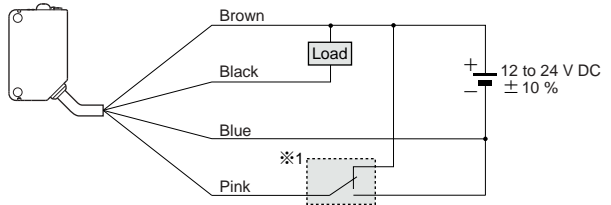

- ※1
- Sensing mode selection input
 - BGS function: Connect to 0 V
 - FGS function: Connect to +V

Connector pin position (Plug-in connector type)

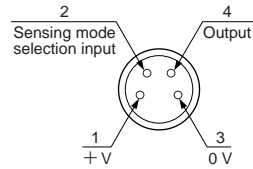

PNP output type

I/O circuit diagram

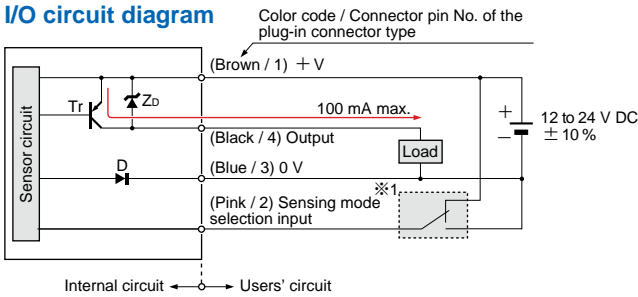

- ※1
- Sensing mode selection input
 - BGS function: Connect to 0 V
 - FGS function: Connect to +V

Symbols ... D : Reverse supply polarity protection diode
 Zd : Surge absorption zener diode
 Tr : PNP output transistor

Wiring diagram

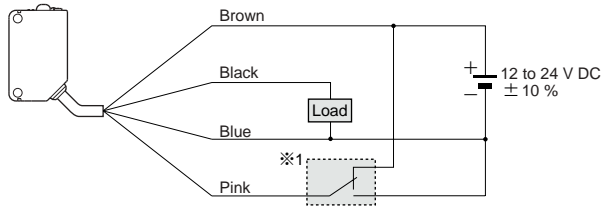

- ※1
- Sensing mode selection input
 - BGS function: Connect to 0 V
 - FGS function: Connect to +V

Connector pin position (Plug-in connector type)

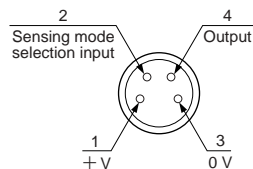

SENSING CHARACTERISTICS (TYPICAL)

**CX-441
CX-441-P**

Short sensing range type

Sensing fields

• Setting distance: 25 mm 0.984 in

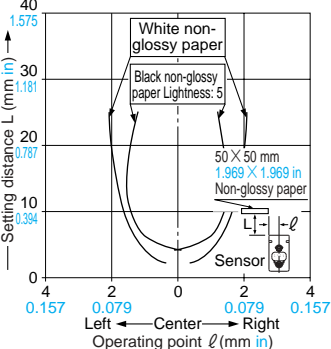

• Setting distance: 50 mm 1.969 in

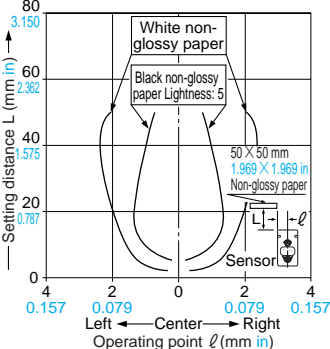

Emitted beam

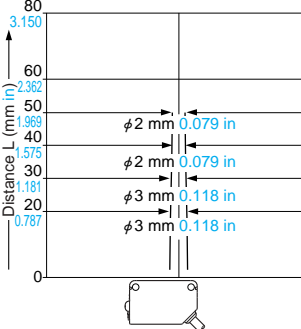

Correlation between color

(50 × 50 mm 1.969 × 1.969 in construction paper) and sensing range

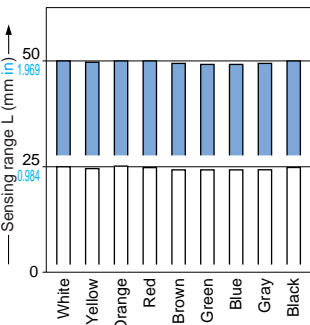

These bars indicate the sensing range with the respective colors when the distance adjuster is set at the sensing range of 50 mm 1.969 in and 25 mm 0.984 in long, each, with white color. The sensing range varies depending also on material.

Correlation between material

(50 × 50 mm 1.969 × 1.969 in) and sensing range

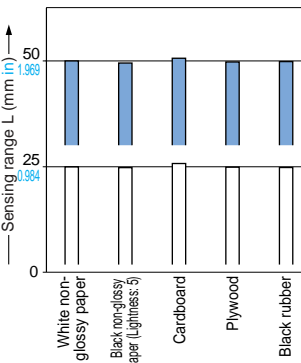

These bars indicate the sensing range with the respective objects when the distance adjuster is set at the sensing range of 50 mm 1.969 in and 25 mm 0.984 in long, each, with white non-glossy paper.

**CX-442
CX-442-P**

Long sensing range type

Sensing fields

• Setting distance: 100 mm 3.937 in

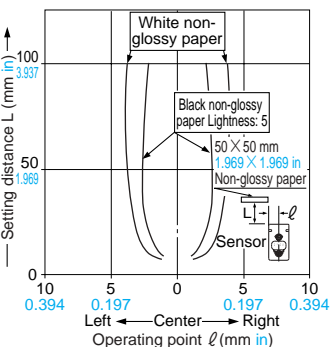

• Setting distance: 200 mm 7.874 in

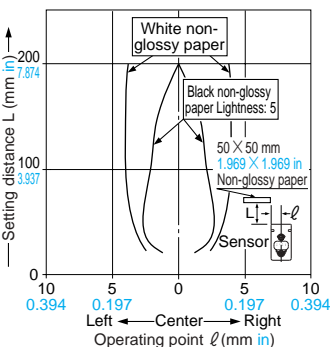

• Setting distance: 300 mm 11.811 in

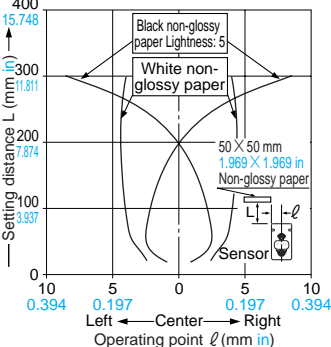

Emitted beam

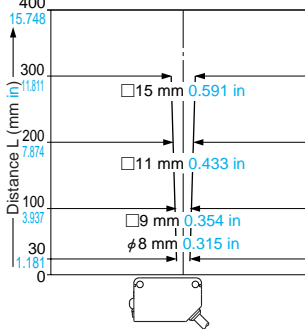

Correlation between color

(50 × 50 mm 1.969 × 1.969 in construction paper) and sensing range

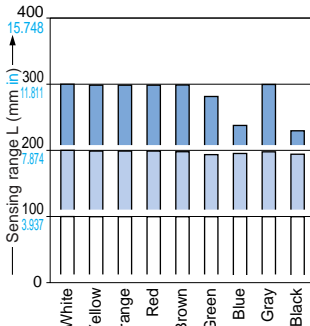

These bars indicate the sensing range with the respective colors when the distance adjuster is set at the sensing range of 300 mm 11.811 in, 200 mm 7.874 in and 100 mm 3.937 in long, each, with white color. The sensing range varies depending also on material.

Correlation between material

(50 × 50 mm 1.969 × 1.969 in) and sensing range

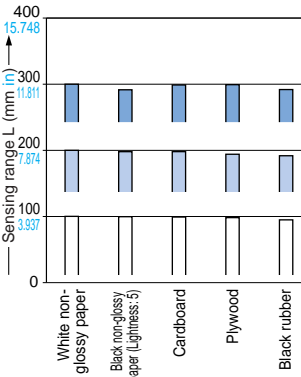

These bars indicate the sensing range with the respective objects when the distance adjuster is set at the sensing range of 300 mm 11.811 in, 200 mm 7.874 in and 100 mm 3.937 in long, each, with white non-glossy paper.

PRECAUTIONS FOR PROPER USE



This product is not a safety sensor. Its use is not intended or designed to protect life and prevent body injury or property damage from dangerous parts of machinery. It is a normal object detection sensor.

Mounting

- The tightening torque should be 0.5 N·m or less.

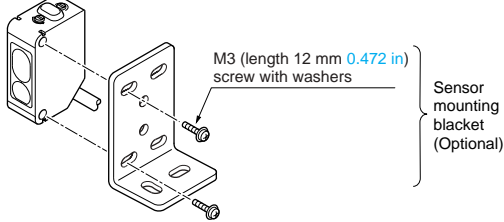

- Care must be taken regarding the sensor mounting direction with respect to the object's direction of movement.

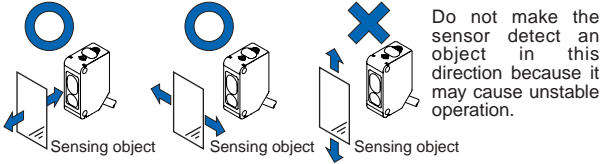

- When detecting a specular object (aluminum or copper foil, etc.) or an object having a glossy surface or coating, please take care that there are cases when the object may not be detected due to a change in angle, wrinkles on the object surface, etc.
- When a specular body is present below the sensor, use the sensor by tilting it slightly upwards to avoid wrong operation.

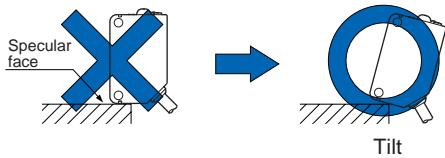

- If a specular body is present in the background, wrong operation may be caused due to a small change in the angle of the background body. In that case, install the sensor at an inclination and confirm the operation with the actual sensing object.
- Take care that there is a non-detectable area right in front of the sensor.



Stability indicator

- Since the CX-400 series uses a 2-segment photodiode as its receiving element, and sensing is done based on the difference in the incident beam angle of the reflected beam from the sensing object, the output and the operation indicator (orange) operate according to the object distance.

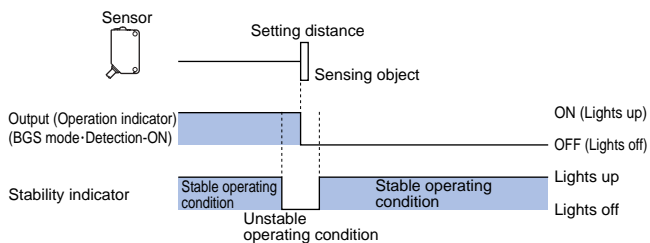
Further, the stability indicator (green) shows the margin of the setting distance.







Operation mode switch

Operation mode switch	Description
	Detection-ON mode is obtained when the operation mode switch is turned fully clockwise (L side).
	Detection-OFF mode is obtained when the operation mode switch is turned fully counterclockwise (D side).

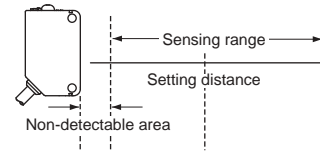
Note: Use the 'minus' screwdriver (please arrange separately) to turn the adjuster slowly. Turning with excessive strength will cause damage to the adjuster.

- Depends on a selection of either BGS or FGS function, the output operation changes as follows.



BGS	Detection-ON (L-ON)		ON OFF
	Detection-OFF (D-ON)		ON OFF
FGS	Detection-ON (L-ON)		ON OFF
	Detection-OFF (D-ON)		ON OFF

BGS / FGS functions

- This sensor incorporates BGS / FGS functions. Select either BGS or FGS function depending on the positions of the background and sensing object.

BGS function

- This function is used when the sensing object is apart from the background.

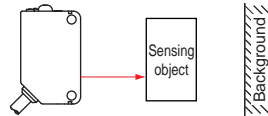

FGS function

- This function is used when the sensing object contacts the background or the sensing object is glossy, etc.

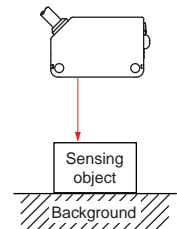

PRECAUTIONS FOR PROPER USE



Distance adjustment





- Since the distance adjuster of this sensor is a 5-turn adjuster, when the point (A) and (B) is adjusted as explained in the table below, there may be more than 1 turn between the point (A) and (B). Therefore, make sure to remember the turns of both points to find the optimum position.
- Be sure to wire the sensing mode selection input (Pink / 2) before distance adjustment. If the wiring is done after the distance adjustment, the sensing area is changed.

- Turn the distance adjuster gradually and lightly with a 'minus' screwdriver (please arrange separately). In order to protect itself, the distance adjuster idles if turned fully. If the adjuster is idled when distance adjustment is done, carry out the adjustment again.

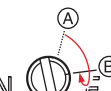
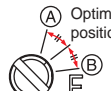
In case BGS function is used

Step	Description	Distance adjuster
①	Turn the distance adjuster fully counterclockwise to the minimum sensing range position. (40 mm 1.575 in approx., 20 mm 0.787 in approx. for CX-441□)	
②	Place an object at the required distance from the sensor, turn the distance adjuster gradually clockwise, and find out point (A) where the sensor changes to the detecting condition.	
③	Remove the object, turn the adjuster clockwise further until the sensor goes into the detecting state again. Once it has entered, turn the distance adjuster backward until the sensor returns to the non-detecting condition. That position is designated as point (B). When the sensor does not go into the detecting condition even if the adjuster is fully turned clockwise, the position where the adjuster was fully turned is regarded as the point (B). (There may be more than 1 turn between the point (A) and (B), since this sensor incorporates 5-turn adjuster.)	
④	The optimum position to stably detect objects is the center point between (A) and (B).	

In case FGS function is used

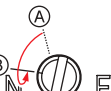
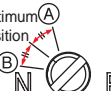
Step	Description	Distance adjuster
①	Turn the distance adjuster fully clockwise to the maximum sensing range position. (300 mm 11.811 in approx., 50 mm 1.969 in approx. for CX-441□)	
②	In the state where the sensor detects the background, turn the distance adjuster gradually counterclockwise, and find out point (A) where the sensor changes to the non-detecting condition.	
③	Place an object at the required distance from the sensor, turn the adjuster counterclockwise further until the sensor goes into the non-detecting condition again. Once it has entered, turn the distance adjuster backward until the sensor returns into the detecting condition. That position is designated as point (B). When the sensor does not go into the non-detecting condition even if the adjuster is fully turned counterclockwise, the position where the adjuster was fully turned is regarded as the point (B). (There may be more than 1 turn between the point (A) and (B), since this sensor incorporates 5-turn adjuster.)	
④	The optimum position to stably detect objects is the center point between (A) and (B).	

Wiring

- Make sure that the power supply is off while wiring and adjusting.
- Take care that wrong wiring will damage the sensor.
- Verify that the supply voltage variation is within the rating.
- If power is supplied from a commercial switching regulator, ensure that the frame ground (F.G.) terminal of the power supply is connected to an actual ground.
- In case noise generating equipment (switching regulator, inverter motor, etc.) is used in the vicinity of this product, connect the frame ground (F.G.) terminal of the equipment to an actual ground.
- Extension up to total 100 m 328.084 ft is possible with 0.3 mm², or more, cable. However, in order to reduce noise, make the wiring as short as possible.
- Do not run the wires together with high-voltage lines or power lines or put them in the same raceway. This can cause malfunction due to induction.

Others

- Do not use during the initial transient time (50 ms) after the power supply is switched on.
- Take care that the sensor is not directly exposed to fluorescent light from a rapid-starter lamp or a high frequency lighting device, as it may affect the sensing performance.
- This sensor is suitable for indoor use only.
- Its distance adjuster is mechanically operated. Avoid drops or other shocks.
- Do not use this sensor in places having excessive vapor, dust, etc., or where it may come in direct contact with water, or corrosive gas.
- Take care that the sensor does not come in direct contact with water, oil, grease or organic solvents, such as, thinner, etc.
- This sensor cannot be used in an environment containing inflammable or explosive gases.
- Never disassemble or modify the sensor.

**CX-441(-P)
CX-442(-P)** Sensor

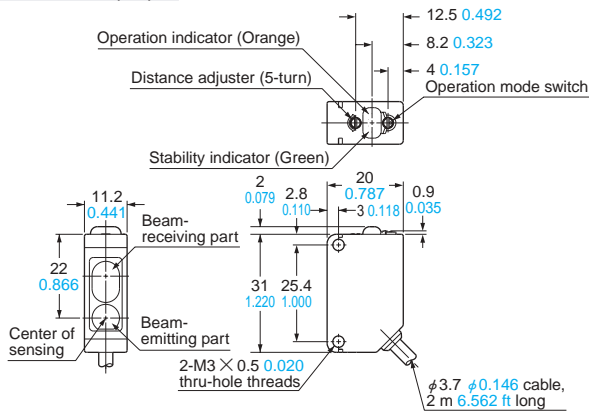

**CX-441(-P)-Z
CX-442(-P)-Z** Sensor

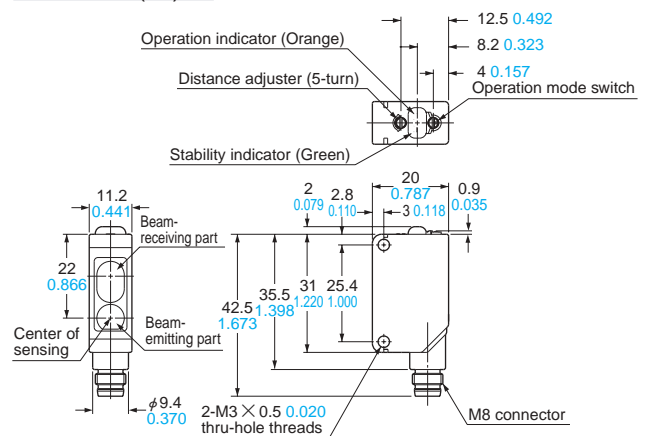

Introduction to lineup of compact photoelectric sensors

Excellent basic performance
The definitive range of multipurpose photoelectric sensors !

- The definitive range of compact photoelectric sensors comprising a full lineup of 60 different models, with current consumption of 60 % less than conventional sensors and greater electrical noise resistance and better resistance to extraneous light such as fluorescent lights.

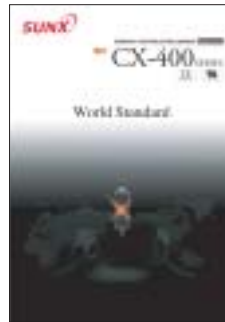

All information is subject to change without prior notice.



<http://www.sunx.co.jp/>

SUNX Limited
2431-1 Ushiyama-cho, Kasugai-shi, Aichi,
486-0901, Japan
Phone: +81-(0)568-33-7211
FAX: +81-(0)568-33-2631

Overseas Sales Dept.
Phone: +81-(0)568-33-7861
FAX: +81-(0)568-33-8591