

EX-40 SERIES

Amplifier Built-in Convergent Reflective Photoelectric Sensor



Reliable Object Detection in Limited Area

CE Marked
Conforming to EMC Directive

Stable Convergent Distance Sensing

Due to convergent distance sensing, the color or material of the object has almost no effect. Further, the background also has very little effect, enabling stable sensing.

EX-43: Correlation between material and sensing range

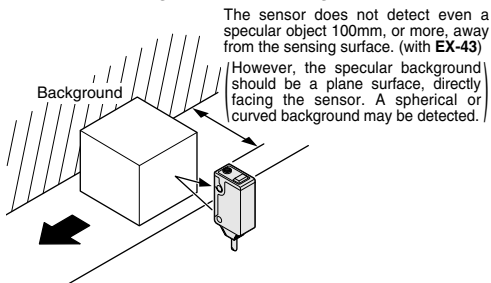
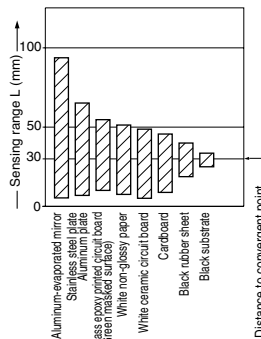

Compact Size (W10 × H30 × D18mm)

It can be installed in a limited space.

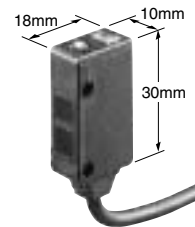

Variable OFF-delay Timer (EX-43T only)

The spot-beam type EX-43T is incorporated with an OFF-delay timer. The variable OFF-delay timer is useful for detecting a printed circuit board regardless of small holes, cutouts or electronic parts on it.

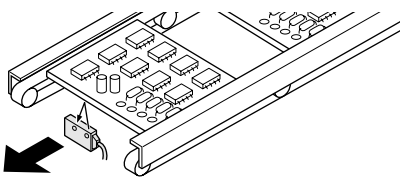

Time chart

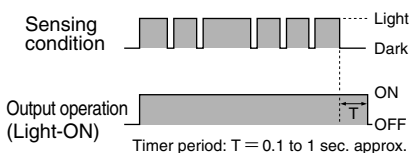

Waterproof

Due to its IP67 construction, there is no problem even if water splashes on the sensor, as on a food processing line.

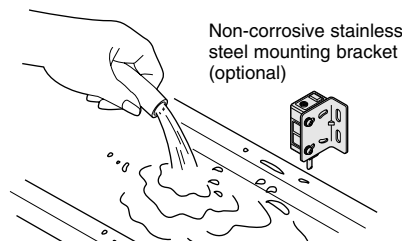

Note: However, take care that if it is exposed to water splashes during operation, it may detect a water drop itself.

Various Applications

Convergent type

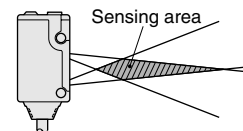

In the limited sensing area, the sensor is not affected by small perforations or unevenness. It is suitable for presence detection.

Spot-beam type

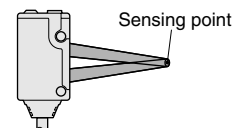

- Visible red spot beam allows easy targeting.
- It is suitable for positioning because of its 0.05mm repeatability.

APPLICATIONS

Determining PCB position

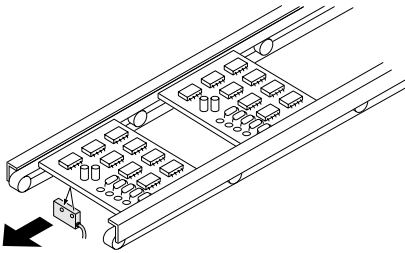

Sensing parts in feeder

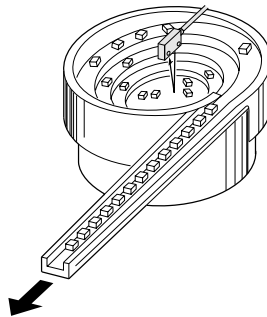

Positioning trays

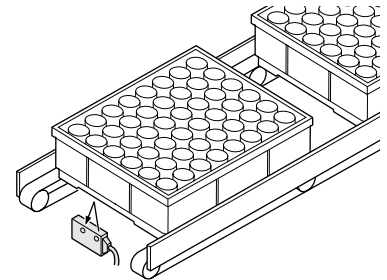

ORDER GUIDE

Type	Appearance	Sensing range (Note 1)	Model No.	Sensitivity adjuster	Timer function	Emitting element
Convergent type		 5 to 38mm (Convergent point: 20mm)	EX-42	—	—	Infrared LED
		 10 to 70mm (Convergent point: 40mm)	EX-44	Incorporated		
Spot-beam type		 20 to 35mm (Convergent point: 30mm)	EX-43	—	Incorporated	Red LED
			EX-43T			

NOTE: Mounting bracket is not supplied with the sensor. Please select from the range of optional sensor mounting brackets (two types).

Note: 1) The sensor does not detect even a specular background if it is separated by the distance specified below.

EX-42 ... 150mm or more, **EX-44** ... 300mm or more, **EX-43** and **EX-43T** ... 100mm or more

(These are typical values. However, the specular background should be a plane surface, directly facing the sensor.)
A spherical or curved background may be detected.

OPTIONS

Designation	Model No.	Description
Sensor mounting bracket	MS-EX40-1	Rear mounting bracket
	MS-EX40-2	Bottom mounting bracket
Universal sensor mounting stand (Note)	MS-AJ	Basic assembly
	MS-AJ-A	Lateral arm assembly

Sensor mounting bracket

• **MS-EX40-1**

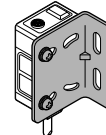

Two M3 (length 16mm) screws with washers are attached.

• **MS-EX40-2**

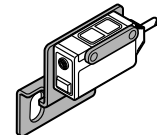

Two M3 (length 16mm) screws with washers are attached.

Universal sensor mounting stand

• **MS-AJ**

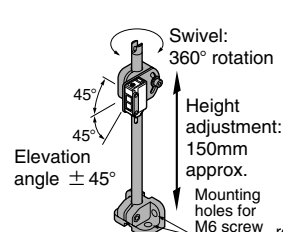

Swivel: 360° rotation
Height adjustment: 150mm approx.

• **MS-AJ-A**

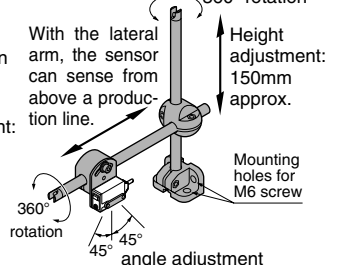

Swivel: 360° rotation
Height adjustment: 150mm approx.

Mounting holes for M6 screw
45° angle adjustment

EX-40

SPECIFICATIONS

Item	Type Model No.	Convergent type		Spot-beam type	
		EX-42	EX-44	EX-43	EX-43T
Sensing range		5 to 38mm (Conv. point: 20mm) with white non-glossy paper (50 × 50mm)	10 to 70mm (Conv. point: 40mm) with white non-glossy paper (50 × 50mm)	20 to 35mm (Conv. point: 30mm) with white non-glossy paper (50 × 50mm)	
Min. sensing object		φ0.2mm copper wire (Setting distance: 20mm)	φ0.2mm copper wire (Setting distance: 40mm)	φ0.03mm gold wire (Setting distance: 30mm)	
Hysteresis		15% or less of operation distance		10% or less of operation distance	
Repeatability (perpendicular to sensing axis)		0.1mm or less (Setting distance: 20mm)	0.2mm or less (Setting distance: 40mm)	0.05mm or less (Setting distance: 30mm)	
Supply voltage		12 to 24V DC ± 10% Ripple P-P 10% or less			
Current consumption		35mA or less			
Output		NPN open-collector transistor <ul style="list-style-type: none"> • Maximum sink current: 100mA • Applied voltage: 30V DC or less (between output and 0V) • Residual voltage: 1.5V or less (at 100mA sink current) 0.4V or less (at 16mA sink current) 			
	Utilization category	DC-12 or DC-13			
	Output operation	Light-ON			
	Short-circuit protection	Incorporated			
Response time		0.5ms or less			
Operation indicator		Red LED (lights up when the output is ON)			
Stability indicator		Green LED (lights up under stable light received condition or stable dark condition)			
Sensitivity adjuster		_____	Continuously variable adjuster		_____
Timer function		_____			Variable OFF-delay timer (0.1 to 1 sec. approx.) (Note)
Environmental resistance	Pollution degree	3 (Industrial environment)			
	Protection	IP67 (IEC)			
	Ambient temperature	- 25 to + 55°C (No dew condensation or icing allowed), Storage: - 30 to + 70°C			
	Ambient humidity	35 to 85% RH, Storage: 35 to 85% RH			
	Ambient illuminance	Sunlight: 10,000 lx at the light-receiving face, Incandescent light: 3,000 lx at the light-receiving face			
	EMC	Emission: EN50081-2, Immunity: EN50082-2			
	Voltage withstandability	1,000V AC for one min. between all supply terminals connected together and enclosure			
	Insulation resistance	20MΩ, or more, with 250V DC megger between all supply terminals connected together and enclosure			
	Vibration resistance	10 to 500Hz frequency, 3mm amplitude (20G max.) in X, Y and Z directions for two hours each			
Shock resistance	500m/s ² acceleration (50G approx.) in X, Y and Z directions for three times each				
Emitting element		Infrared LED (modulated)		Red LED (modulated)	
Material		Polyalylate			
Cable		0.2mm ² 3-core cabtyre cable, 2m long			
Cable extension		Extension up to total 100m is possible with 0.3mm ² , or more, cable.			
Weight		45g approx.			
Accessory		_____	Adjusting screwdriver: 1No.		

Note: The timer is always effective.

I/O CIRCUIT AND WIRING DIAGRAMS

I/O circuit diagram

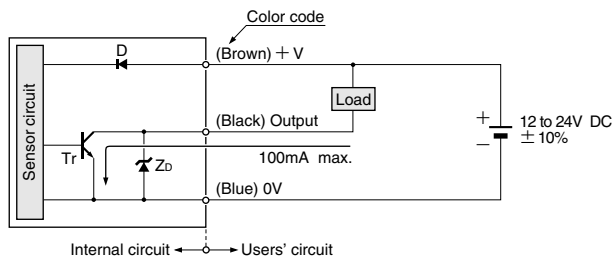

Symbols ... D: Reverse supply polarity protection diode
 Zd: Surge absorption zener diode
 Tr: NPN output transistor

Wiring diagram

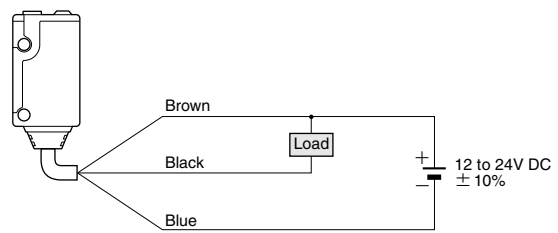

SENSING CHARACTERISTICS (TYPICAL)

EX-42

Sensing field

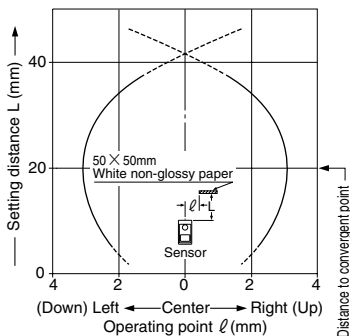

Correlation between sensing object size and sensing range

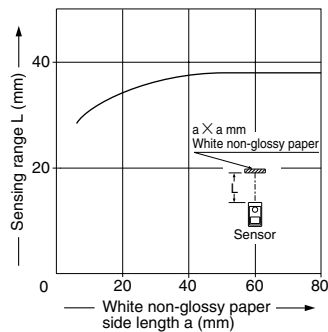

As the sensing object size becomes smaller than the standard size (white non-glossy paper 50 × 50mm), the sensing range shortens, as shown in the left graph.

(For plotting the left graph, a sensor having a sensitivity such that it can just detect a 50 × 50mm white non-glossy paper at a distance of 38mm has been used.)

Correlation between lightness and sensing range

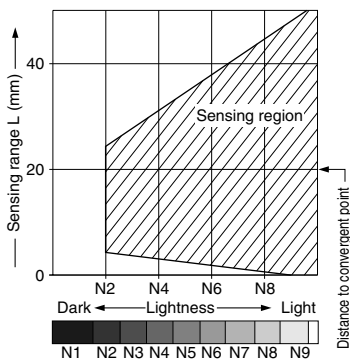

The sensing region is represented by oblique lines in the left figure. However, the sensitivity should be set with enough margin because of slight variation in products.

(Lightness shown on the left may differ slightly from the actual object condition.)

Correlation between material (50 × 50mm) and sensing range

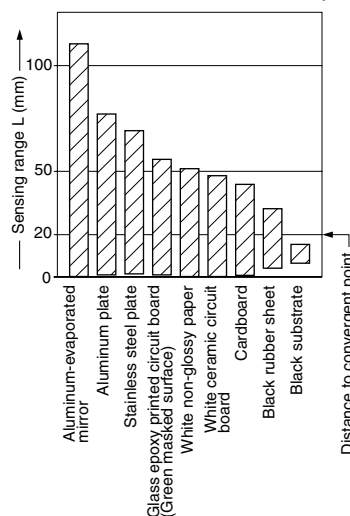

The bars in the graph indicate the sensing range for the respective material. However, there is a slight variation in the sensing range depending on the product. Further, if there is a reflective object (conveyor, etc.) in the background of the sensing object, since it affects the sensing, separate it by more than twice the sensing range shown in the left graph.

EX-40

SENSING CHARACTERISTICS (TYPICAL)

EX-44

Sensing field

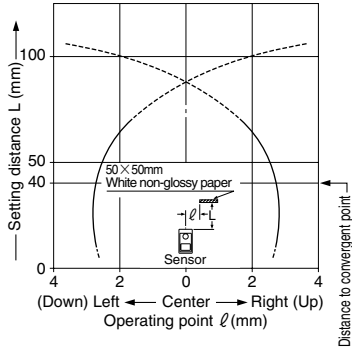

Correlation between sensing object size and sensing range

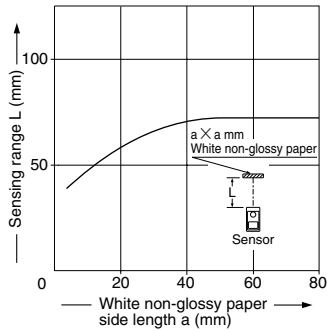

As the sensing object size becomes smaller than the standard size (white non-glossy paper 50 × 50mm), the sensing range shortens, as shown in the left graph.

(For plotting the left graph, the sensitivity has been set such that a 50 × 50mm white non-glossy paper is just detectable at a distance of 70mm.)

Correlation between lightness and sensing range

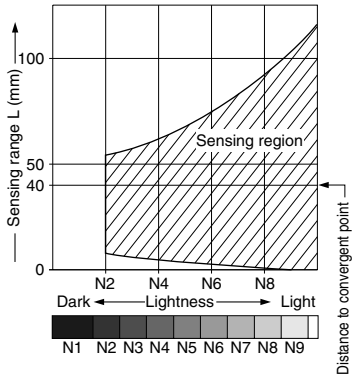

The sensing region is represented by oblique lines in the left figure. However, the sensitivity should be set with enough margin because of slight variation in products. (The graph is drawn for the maximum sensitivity setting.)

(Lightness shown on the left may differ slightly from the actual object condition.)

Correlation between material (50 × 50mm) and sensing range

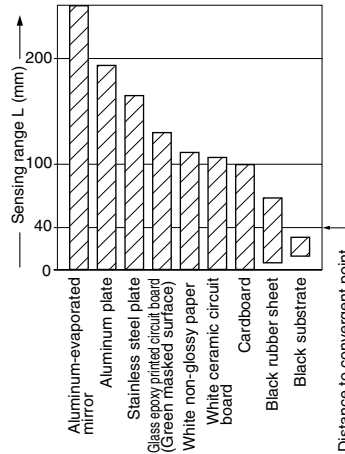

The bars in the graph indicate the sensing range for the respective material. However, there is a slight variation in the sensing range depending on the product. Further, if there is a reflective object (conveyor, etc.) in the background of the sensing object, since it affects the sensing, separate it by more than twice the sensing range shown in the left graph, or adjust the sensitivity adjuster.

(The graph is drawn for the maximum sensitivity setting.)

EX-43 EX-43T

Sensing field

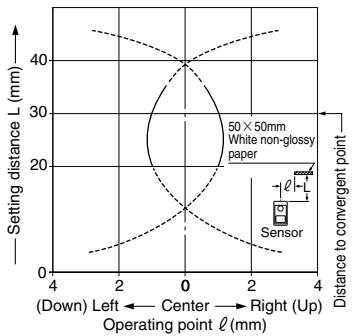

Correlation between lightness and sensing range

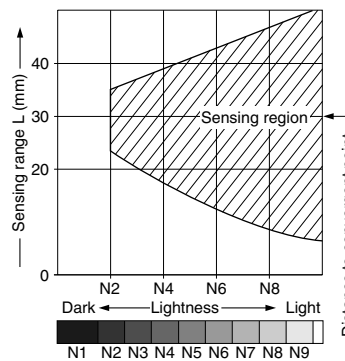

The sensing region is represented by oblique lines in the left figure. However, the sensitivity should be set with enough margin because of slight variation in products.

(The graph is drawn for the maximum sensitivity setting. However, EX-43T does not incorporate the sensitivity adjuster.)

(Lightness shown on the left may differ slightly from the actual object condition.)

Correlation between material (50 × 50mm) and sensing range

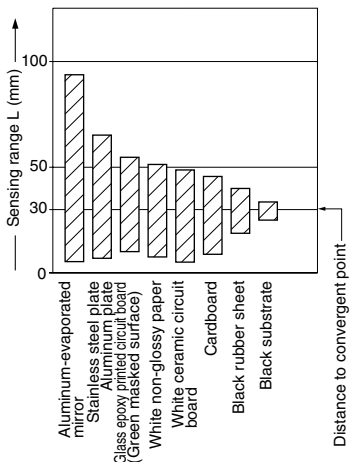

The bars in the graph indicate the sensing range for the respective material. However, there is a slight variation in the sensing range depending on the product. Further, if there is a reflective object (conveyor, etc.) in the background of the sensing object, since it affects the sensing, separate it by more than twice the sensing range shown in the left graph, or adjust the sensitivity adjuster.

(The graph is drawn for the maximum sensitivity setting. However, EX-43T does not incorporate the sensitivity adjuster.)

PRECAUTIONS FOR PROPER USE



This product is not a safety sensor. Its use is not intended or designed to protect life and prevent body injury or property damage from dangerous parts of machinery. It is a normal object detection sensor.

Mounting

- With the optional sensor mounting bracket, the tightening torque should be 0.5 N·m or less.

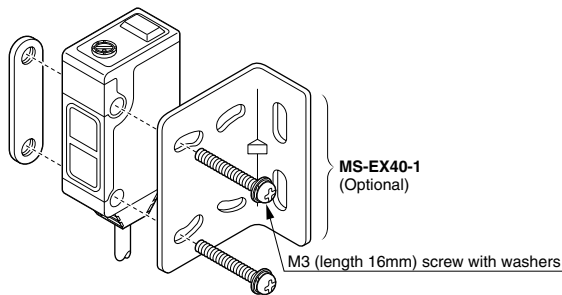

Others

- Do not use during the initial transient time (50ms) after the power supply is switched on.

Timer function (Only for EX-43T)

- The variable OFF-delay timer prolongs the output for a certain period (0.1 to 1 sec. approx.). It is useful when the connected device has a slow response time or when small objects are sensed and the signal width is small. (The timer is always effective.)

Adjusters

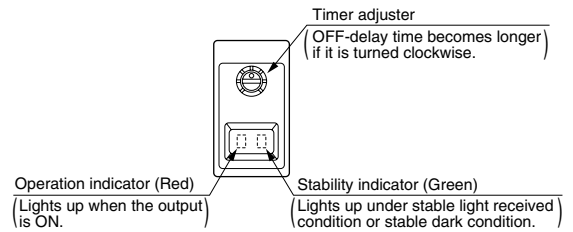

Time chart

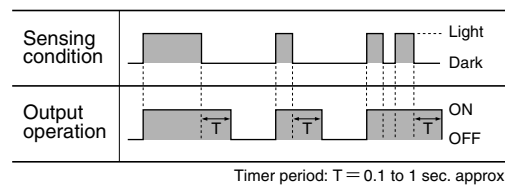

EX-40

DIMENSIONS (Unit: mm)

EX-42 EX-44
EX-43 EX-43T Sensor

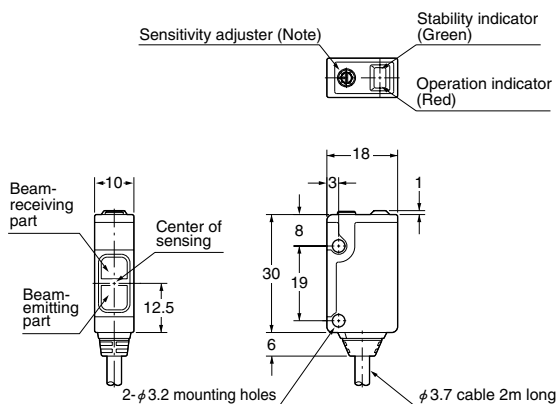

Note: EX-42 does not incorporate it.
In EX-43T, it is the timer adjuster.

MS-EX40-1 Sensor mounting bracket (Optional)

Assembly dimensions

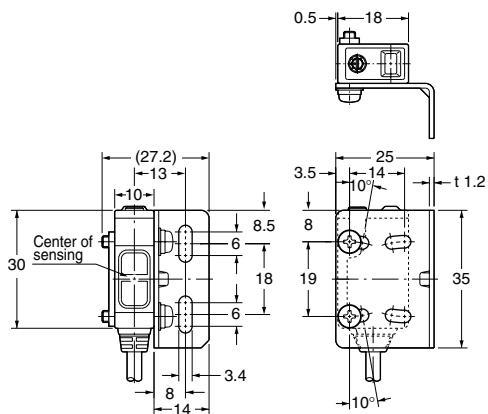
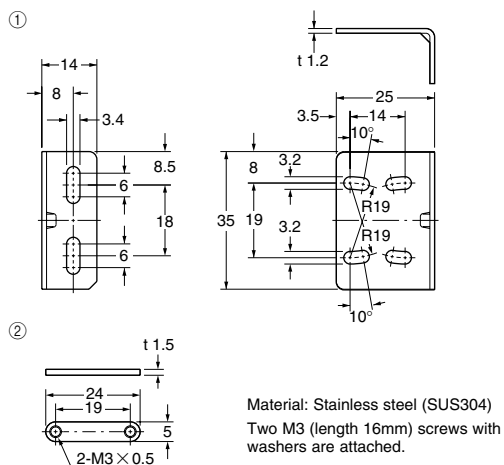

MS-EX40-2 Sensor mounting bracket (Optional)

Assembly dimensions

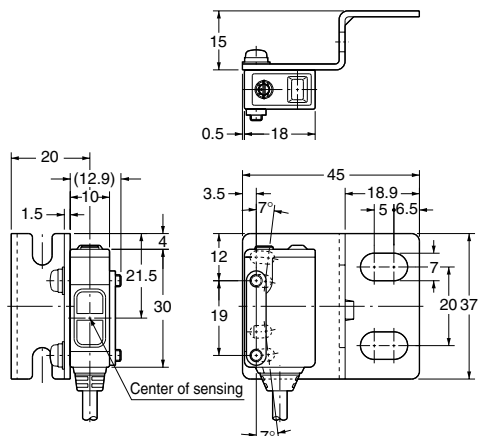
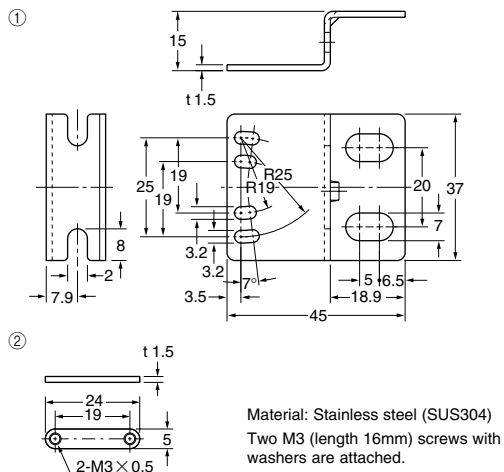

DIMENSIONS (Unit: mm)

MS-AJ

Universal sensor mounting stand: basic assembly (Optional)

Assembly dimensions (Mounting part only)

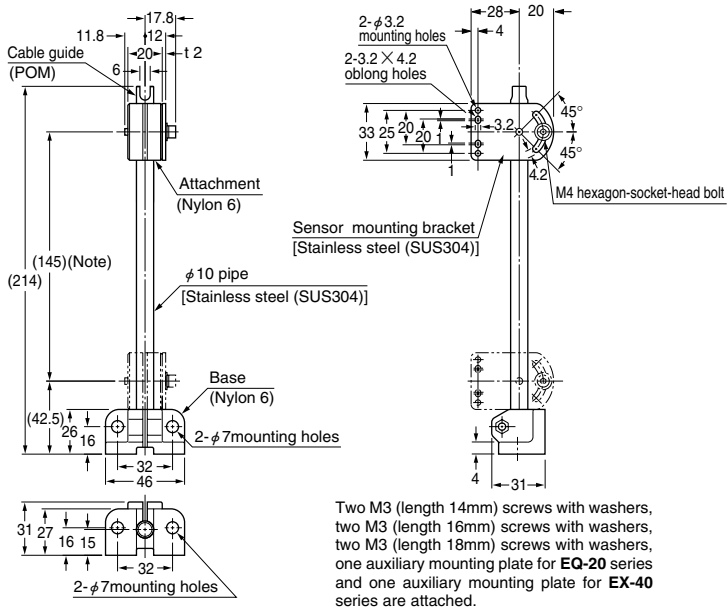

Note: The dimensions in the brackets indicate the adjustable range of the movable part.

MS-AJ-A

Universal sensor mounting stand: lateral arm assembly (Optional)

Assembly dimensions (Mounting part only)

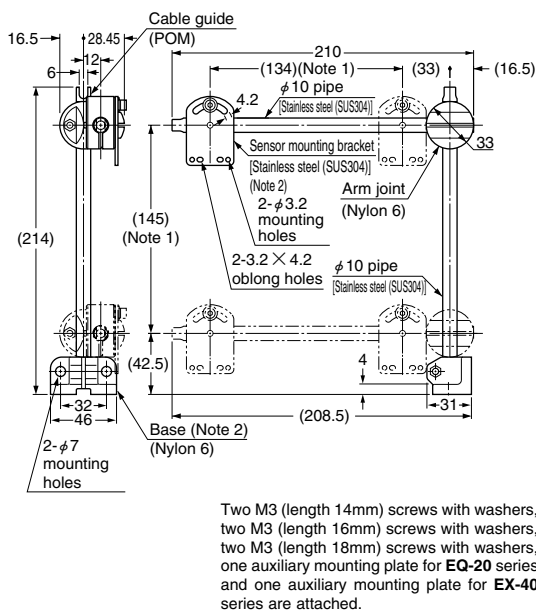

Notes: 1) The dimensions in the brackets indicate the adjustable range of the movable part.

2) Refer to **MS-AJ** (basic assembly) for the assembled diagram with the base, sensor mounting bracket, sensor or reflector.