

Panasonic
ideas for life

**DIN48 SIZE
MULTI-RANGE ANALOG TIMER**

**PM4H-A
PM4H-S
PM4H-M**

UL File No.: E122222 CSA File No.: LR39291

FEATURES

- Front panel of IP65 type is protected against water-splash and dust
- 100-240V AC free-voltage input, 48-125V DC type available
- Built-in Screw terminals
- Screw terminal type is used for easy wiring and reducing additional cost for accessories.
- 8 different operation modes: (PM4H-A)
- Tube base with pin style terminals
- Multiple time ranges — 1 s to 500 h (Max.)
- Short body — 62.5mm 2.461 inch (screw terminal type)

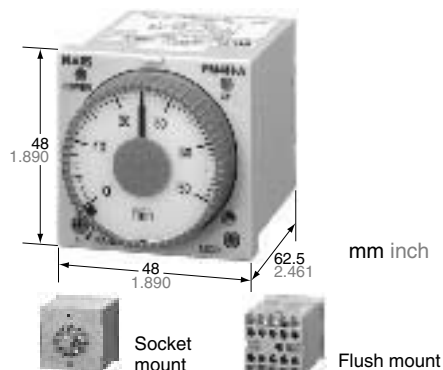

PRODUCT TYPE

Type	Operation mode	Contact arrangement	Time range	Protective construction	Rated operating voltage	Terminal type	Part No.
PM4H-A	8 operation modes • Pulse ON-delay • Pulse Flicker • Pulse ON-flicker • Differential ON/OFF-delay (1) (2) • Signal OFF-delay • Pulse One-shot • Pulse One-cycle	Relay Timed-out 2 Form C	16 selectable ranges 1s to 500h	IP65	100 to 240V AC	11 pin	PM4HA-H-AC240VW
					24V AC/DC	Screw terminal	PM4HA-H-AC240VSW
						11 pin	PM4HA-H-24VW
					Screw terminal	PM4HA-H-24VSW	
				IP50	12V DC	11 pin	PM4HA-H-DC12VW
					100 to 240V AC	Screw terminal	PM4HA-H-AC240V
						11 pin	PM4HA-H-AC240VS
					24V AC/DC	Screw terminal	PM4HA-H-24V
11 pin	PM4HA-H-24VS						
PM4H-S	Power ON-delay	Relay Timed-out 2 Form C	16 selectable ranges 1s to 500h	IP65	100 to 240V AC	8 pin	PM4HS-H-AC240VW
					24V AC/DC	Screw terminal	PM4HS-H-AC240VSW
						8 pin	PM4HS-H-24VW
					Screw terminal	PM4HS-H-24VSW	
				IP50	12V DC	8 pin	PM4HS-H-DC12VW
					100 to 240V AC	Screw terminal	PM4HS-H-AC240V
						8 pin	PM4HS-H-AC240VS
					24V AC/DC	Screw terminal	PM4HS-H-24V
8 pin	PM4HS-H-24VS						
PM4H-M	5 operation modes (With instantaneous contact) • Power ON-delay • Power Flicker • Power ON-flicker • Power One-shot • Power One-cycle	Relay Timed-out 1 Form C Instantaneous 1 Form C	16 selectable ranges 1s to 500h	IP65	100 to 240V AC	8 pin	PM4HM-H-AC240VW
					24V AC/DC	Screw terminal	PM4HM-H-AC240VSW
						8 pin	PM4HM-H-24VW
					Screw terminal	PM4HM-H-24VSW	
				IP50	12V DC	8 pin	PM4HM-H-DC12VW
					100 to 240V AC	Screw terminal	PM4HM-H-DC12VSW
						8 pin	PM4HM-H-AC240V
					24V AC/DC	Screw terminal	PM4HM-H-AC240VS
8 pin	PM4HM-H-24V						
12V DC	Screw terminal	PM4HM-H-24VS					
	8 pin	PM4HM-H-DC12V					
Screw terminal	PM4HM-H-DC12VS						

If you use this timer under harsh environment, please order above sealed type (IP65 type). IP65 type — Protection dust and water jet splay on the front face.
When ordering CE type, please order the Part No. with suffix CE. (e.g. PM4HA-H-AC240VWCE)

TIME RANGE

Scale	Time unit	Control time range			
		sec	min	hrs	10h
1	Control time range	0.1s to 1s	0.1 min to 1 min	0.1h to 1h	1.0h to 10h
5		0.5s to 5s	0.5 min to 5 min	0.5h to 5h	5h to 50h
10		1.0s to 10s	1.0 min to 10 min	1.0h to 10h	10h to 100h
50		5s to 50s	5 min to 50 min	5h to 50h	50h to 500h

Note: 0 setting is for instantaneous output operation.

PM4H-A/PM4H-S/PM4H-M

All types of PM4H timer have multi-time range.

16 time ranges are selectable.

1s to 500h (Max. range) is controlled.

CHARACTERISTICS

Item	Type	PM4H-A	PM4H-S	PM4H-M
Rating	Rated operating voltage	100 to 240V AC, 12V DC, 24V AC/DC, 48 to 125V DC		
	Rated frequency	50/60Hz common (AC operating type)		
	Rated power consumption	Approx. 10VA (100 to 240V AC) Approx. 2.5VA (24V AC) Approx. 2W (12V DC, 24V DC, 48 to 125V DC)		
	Output rating	5A 250V AC (resistive load)		
	Operating mode	Pulse ON-delay Pulse Flicker Pulse ON-Flicker Differential ON/OFF-delay (1) (2) Signal OFF-delay Pulse One-shot Pulse One-cycle	Power ON-delay	Power ON-delay Power Flicker Power ON-flicker Power One-shot Power One-cycle (with instantaneous contact)
	Time range	1s to 500h (Max.) 16 time ranges switchable		
Time accuracy (Note:)	Operating time fluctuation	±0.3% (power off time change at the range of 0.1s to 1h)		
	Setting error	±5% (Full-scale value)		
	Voltage error	±0.5% (at the operating voltage changes between 85 to 110%)		
	Temperature error	±2% (at 20°C ambient temp. at the range of -10 to +50°C +14 to +122°F)		
Contact	Contact arrangement	Timed-out 2 Form C		Timed-out 1 Form C Instantaneous 1 Form C
	Contact resistance (Initial value)	Max. 100mΩ (at 1A 6V DC)		
	Contact material	Silver alloy		Au flash on Silver alloy
Life	Mechanical (contact)	2×10 ⁷		
	Electrical (contact)	10 ⁵ (at rated control capacity)		
Electrical function	Allowable operating voltage range	85 to 110% of rated operating voltage (at 20°C coil temp.)		
	Insulation resistance (Initial value)	Min. 100MΩ	Between live and dead metal parts Between input and output Between contacts of different poles Between contacts of same pole	(At 500V DC)
	Breakdown voltage (Initial value)	2,000Vrms for 1 min Between live and dead metal parts 2,000Vrms for 1 min Between input and output 2,000Vrms for 1 min Between contacts of different poles 1,000Vrms for 1 min Between contacts of same pole		
	Min. power off time	100ms		
	Max. temperature rise	55°C 131°F		65°C 149°F
Mechanical function	Shock resistance	Functional	Min. 98m/s ² (4 times on 3 axes)	
		Destructive	Min. 980m/s ² (5 times on 3 axes)	
	Vibration resistance	Functional	10 to 55Hz: 1 cycle/min double amplitude of 0.5mm (10min on 3 axes)	
		Destructive	10 to 55Hz: 1 cycle/min double amplitude of 0.75mm (1h on 3 axes)	
Operating condition	Ambient temperature	-10 to +50°C +14 to +122°F		
	Ambient humidity	Max. 85%RH		
	Atmospheric pressure	860 to 1,060hPa		
	Ripple factor (DC type)	20%		
Others	Protective construction	IP65 on front panel (using rubber gasket ATC18002) <only for IP65 type>		
	Weight	100g 3.527 oz (Pin type) 110g 3.880 oz (Screw terminal type)		

Note: 1) Unless otherwise specified, the measurement conditions at the maximum scale time standard are specified to be the rated operating voltage (within 5% ripple factor for DC), 20°C 68°F ambient temperature, and 1s power off time.
2) For the 1s range, the tolerance for each specification becomes ±10ms.

WIRING DIAGRAMS

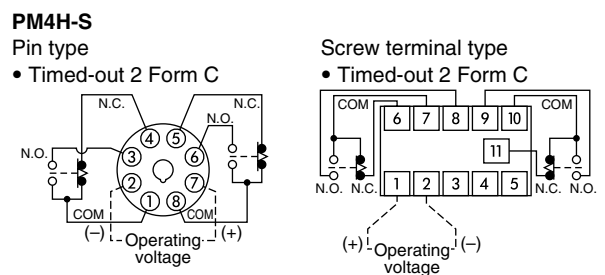
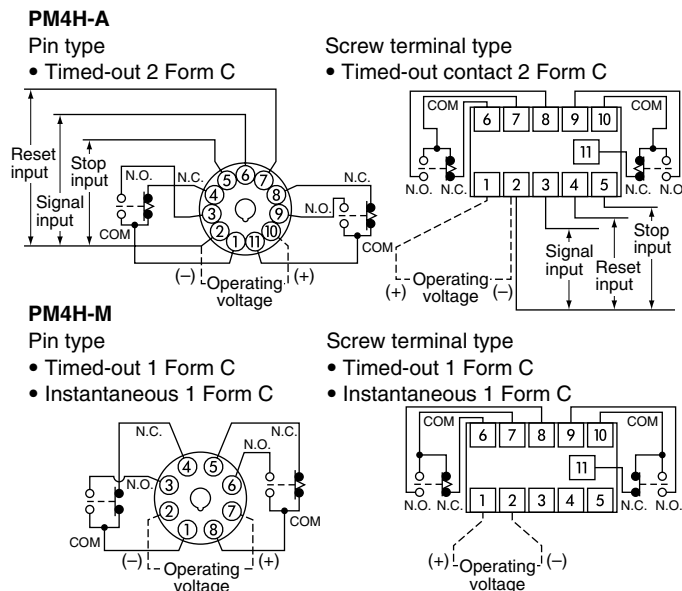

1) DC Type

Type	Pin	Screw terminal
PM4H-A	Connect the terminal ② to negative (-), and the terminal ⑩ to positive (+).	Connect the terminal x to negative (-), and the terminal z to positive (+).
PM4H-S PM4H-M	Connect the terminal ② to negative (-), and the terminal ⑦ to positive (+).	

2) Contact



PARTS NAME

PM4H-S



PM4H-A

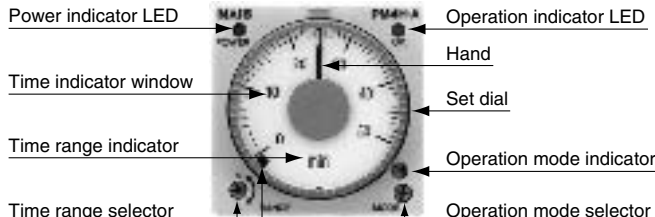

PM4H-M



16 time settings selectable
 1 s to 500 h
 1s 5s 10s 50s
 1min 5min 10min 50min
 1h 5h 10h 50h
 10h 50h 100h 500h

Instantaneous output area
 When the hand is in this area,
 instantaneous operation starts.

Selectable from 8 operation modes
 ON : Pulse ON-delay
 FL : Pulse Flicker
 FO : Pulse ON-flicker
 OF1 : Differential ON/OFF-delay (1)
 SF : Signal OFF-delay
 OS : Pulse One-shot
 OF2 : Differential ON/OFF-delay (2)
 OC : Pulse One-cycle

Selectable from 5 operation modes
 ON : Power ON-delay
 FL : Power flicker
 FO : Power ON-flicker
 OS : Power One-shot
 OC : Power One-cycle

DIMENSIONS

mm inch

• **PM4H-□**

Screw terminal type
 (Flush mount)

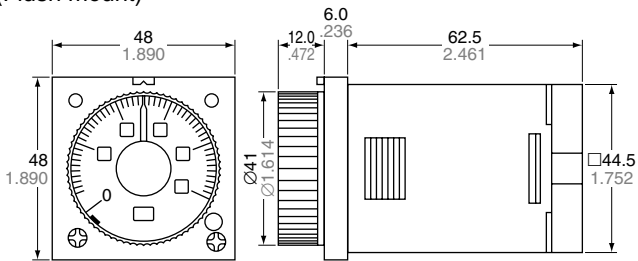

Pin type
 (Flush mount/Surface mount)

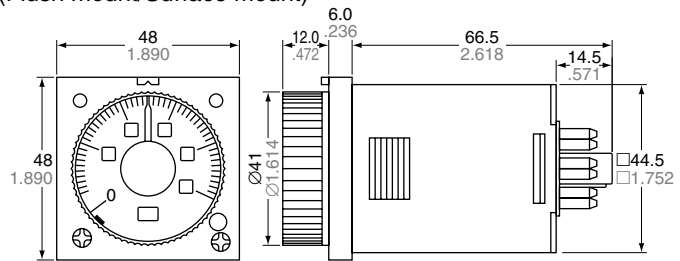

• **Panel mount dimensions (with mounting frame)**

Screw terminal type

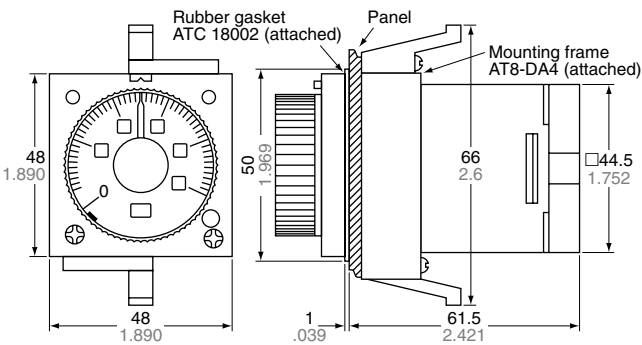

Pin type

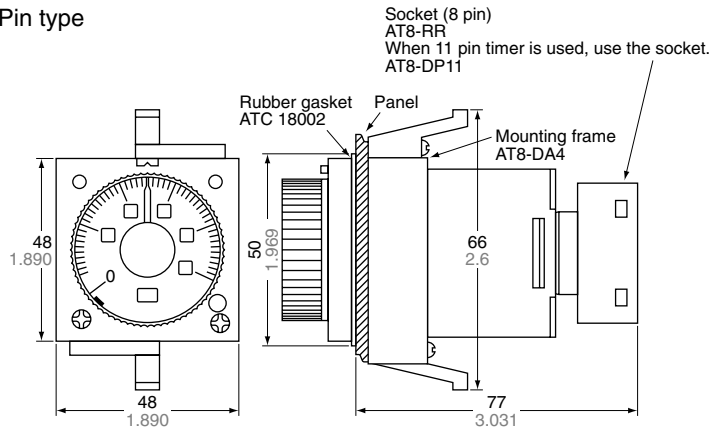

• **Surface mount dimensions**

Socket mount (Pin type)

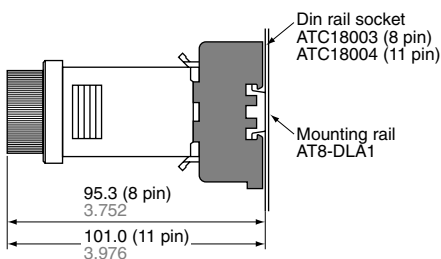

• **Panel cut out dimensions**

Standard cut out dimensions are shown below.
 Use mounting frame (AT8-DA4) and rubber gasket (ATC18002).

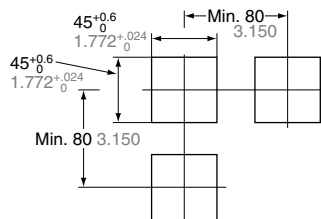

• **Adjacent mounting**

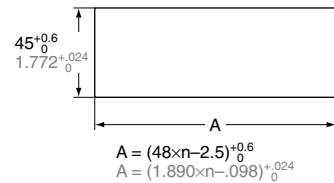

Note: 1. The proper thickness of mounting panel is between 1 to 5mm.
 2. Adjacent mount is less water-resistant.







OPERATION MODE
PM4H-A

The new settings
are valid after power OFF → ON

(* LED lighting * LED flickering
T: Setting time $t_1, t_2, t_a, t_b < T$ $t_1 + t_2 = T$)

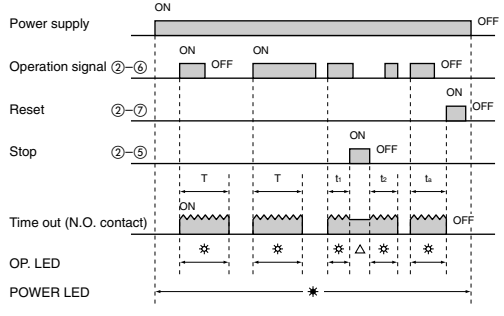
Operation mode	Operation	Time chart
<p>Pulse ON-delay ON</p>	<p>Turn the operation selector to ON.</p> <p>Power is applied continuously. When a start signal is applied, the time cycle begins. The output contacts change state after the time delay is completed. The contacts will return to their normal state when a reset signal is applied or power is removed.</p> <p>(Note: When a stop signal is applied during timing operation, the time cycle stops. When a stop signal is removed, the time cycle begins.)</p>	<p>△Note: * LED lighting or No LED lighting</p>
<p>Pulse Flicker FL</p>	<p>Turn the operation selector to FL.</p> <p>Power is applied continuously. When a start signal is applied, the time cycle begins but the output contacts remain in their normal state. When the time delay is completed, the output contacts change state and next time cycle begins. When this time delay is completed, the output contacts return to their normal state. This cycle will repeat until a reset signal is applied or power is removed.</p> <p>(Note: When a stop signal is applied during timing operation, the time cycle stops. When a stop signal is removed, the time cycle begins.)</p>	<p>△Note: * LED lighting or No LED lighting</p>
<p>Pulse ON-flicker FO</p>	<p>Turn the operation selector to FO.</p> <p>Power is applied continuously. When a start signal is applied, the output contacts change state immediately and time cycle begins. When the time delay is completed, the output contacts change state and next time cycle begins. When the time delay is completed, the output contacts return to the normal state.</p> <p>This cycle will repeat until a reset signal is applied or power is removed.</p> <p>(Note: When a stop signal is applied during timing operation, the time cycle stops. When a stop signal is removed, the time cycle begins.)</p>	<p>△Note: * LED lighting or No LED lighting</p>
<p>Differential ON/OFF-delay (1) OF1</p>	<p>Turn the operation selector to OF1.</p> <p>Power is applied continuously. When a start signal is applied, the output contacts change state immediately and time cycle begins. The output contacts change state after the timing cycle is completed. When the start signal is removed, the output contacts change state and time cycle starts again. If operation signal is turned ON or OFF during timing operation, time cycle restart at that point.</p> <p>The output contacts will return to their normal state when a reset signal is applied or power is removed.</p> <p>(Note: When a stop signal is applied during timing operation, the time cycle stops. When a stop signal is removed, the time cycle begins.)</p>	<p>△Note: * LED lighting or No LED lighting</p>
<p>Signal OFF-delay SF</p>	<p>Turn the operation selector to SF.</p> <p>Power is applied continuously. When a start signal is applied, the output contacts change state immediately. When the start signal is removed the time cycle begins. The output contacts will return to their normal state when the time delay is completed.</p> <p>Reset will occur when a reset signal is applied or power is removed.</p> <p>(Note: When a stop signal is applied during timing operation, the time cycle stops. When a stop signal is removed, the time cycle begins.)</p>	<p>△Note: * LED lighting or No LED lighting</p>

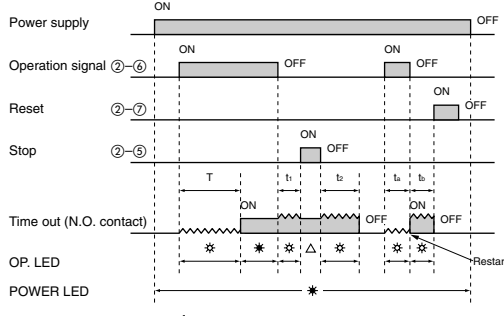
Note: Keep 0.1s or more for power off time.
Keep 0.05s or more for signal, stop, reset input time.

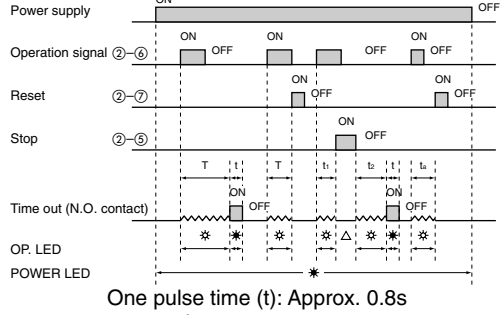
Operation mode	Operation	Time chart
Pulse One-shot 	Turn the operation selector to  . Power is applied continuously. When a start signal is applied, the output contacts change state immediately and time cycle begins. When the time delay is completed, the output contacts return to their normal state. The contacts will return to normal state when a reset signal is applied or power is removed. (Note: When a stop signal is applied during timing operation, the time cycle stops. When a stop signal is removed, the time cycle begins.)	 <p>△Note: * LED lighting or No LED lighting</p>
Differential ON/OFF-delay (2) 	Turn the operation selector to  . Power is applied continuously. When a start signal is applied, the time cycle begins but output contacts remain in their normal state. The output contacts change state after time delay is completed. When the start signal is removed the time cycle begins. The output contacts return to their normal state after time delay is completed. The start signal is applied or start signal is removed while timing operation, the output contacts change state and time cycle begins at this point. The contacts will return to their normal state when a reset signal is applied or power is removed. (Note: When a stop signal is applied during timing operation, the time cycle stops. When a stop signal is removed, the time cycle begins.)	 <p>△Note: * LED lighting or No LED lighting</p>
Pulse One-cycle 	Turn the operation selector to  . Power is applied continuously. When a start signal is applied, the time cycle begins but the output contacts remain in their normal state. The output contacts change state for 0.8s after time delay is completed. Reset will occur when a reset signal is applied or power is removed. (Note: When a stop signal is applied during timing operation, the time cycle stops. When a stop signal is removed, the time cycle begins.)	 <p>One pulse time (t): Approx. 0.8s △Note: * LED lighting or No LED lighting</p>



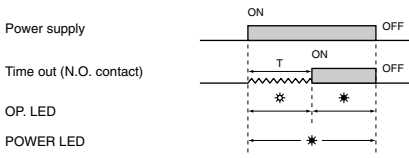

Note: Keep 0.1s or more for power off time.
 Keep 0.05s or more for signal, stop, reset input time.

OPERATION MODE PM4H-S

(* LED lighting * LED flickering
 T: Setting time)

Operation mode	Operation	Time chart
Power ON-delay	When power is applied continuously, the time cycle begins. The output contacts change state after the time delay is completed.	

PM4H-M

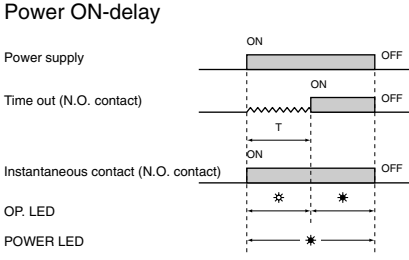
Operation mode	Operation	Time chart
Power ON-delay  Power Flicker  Power ON-flicker  Power One-shot  Power One-cycle 	Power ON-delay When power is applied continuously, the output contacts change state. Reset will occur when power is removed. PM4H-M timers does not have each input which is signal, reset and stop. (As for other operation mode, refer to the operation mode of PM4H-A.)	

Note: Keep 0.1s or more for power off time. PM4H-M timers do not have each input which is signal, reset and stop.

	DIN48 SIZE ANALOG STAR (∟)-DELTA (Δ) TIMERS	PM4H-SD/SDM
---	--	--------------------

UL File No.: E122222
CSA File No.: LR39291

FEATURES

- Select four types of time ranges between 0.2 s and 100 s on a single unit.
- Select between five types of time ranges between 0.04 s and 0.7 s for the ∟-Δ switching times.
- There is a ∟-Δ switching indicator so you can check the operation at a glance.
- The AC free power supply and shorter body make it easier to use.

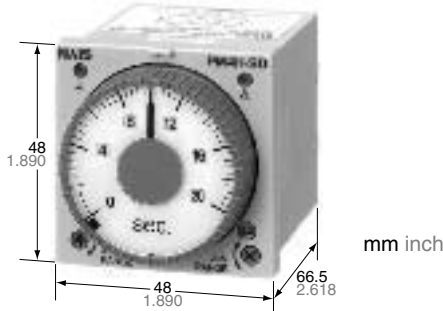

CHARACTERISTICS

Item	Type	PM4H-SD/SDM	
Rating	Rated operating voltage	100 to 240V AC, 24V AC	
	Rated frequency	50/60Hz common	
	Rated power consumption	Approx. 10VA (100 to 240V AC) Approx. 2.5VA (24V AC)	
	Output rating	5A 250V AC (resistive load)	
	Operation mode	∟-Δ star-delta switching (Power ON-delay)	
	∟ operation control time range	2s to 100s, 4 time ranges switchable	
	∟-Δ switching time	0.04, 0.1, 0.3, 0.5, 0.7s (5 time range selectable)	
Time accuracy <i>Note:)</i>	Operation time fluctuation	±0.3% (power off time change at the range of 0.5s to 1h)	
	Setting error	±5% (Full-scale value)	
	Voltage error	±0.5% (at the operating voltage changes between 85 to 110%)	
	Temperature error	±2% (at 20°C ambient temp. at the range of -10 to +50°C +14 to +122°F)	
Contact	Contact arrangement	Star (∟) side: Timed-out 1 Form A Delta (Δ) side: Timed-out 1 Form A Instantaneous: 1 Form A (Instantaneous for SDM type only)	
	Contact resistance (Initial value)	Max. 100mΩ (at 1A 6V DC)	
	Contact material	Au flash on Silver alloy	
Life	Mechanical (contact)	2×10 ⁷	
	Electrical (contact)	10 ⁵ (at rated control capacity)	
Electrical function	Allowable operating voltage range	85 to 110% of rated operating voltage (at 20°C coil temp.)	
	Insulation resistance (Initial value)	Min. 100MΩ Between live and dead metal parts Between input and output Between contacts of different poles *3 (At 500V DC) Between contacts of same pole	
	Breakdown voltage (Initial value)	2,000Vrms for 1 min Between live and dead metal parts 2,000Vrms for 1 min Between input and output 2,000Vrms for 1 min Between contacts of different poles *3 1,000Vrms for 1 min Between contacts of same pole	
	Min. power off time	500ms	
	Max. temperature rise	65°C 131°F	
	Mechanical function	Shock resistance	Functional
Destructive			Min. 980m/s ² (5 times on 3 axes)
Vibration resistance		Functional	10 to 55Hz: 1 cycle/min double amplitude of 0.5mm (10min on 3 axes)
		Destructive	10 to 55Hz: 1 cycle/min double amplitude of 0.75mm (1h on 3 axes)
Operating condition	Ambient temperature	-10 to +50°C +14 to +122°F	
	Ambient humidity	Max. 85%RH	
	Atmospheric pressure	860 to 1,060hPa	
Others	Protective construction	IP65 on front panel (using rubber gasket ATC18002) <only for IP65 type>	
	Weight	100g 3.527 oz (Pin type) 110g 3.880 oz (Screw terminal type)	

Notes: 1) Unless otherwise specified, the measurement conditions at the maximum scale time standard are specified to be the rated operating voltage, 20°C 68°F ambient temperature, and 1s power off time.

2) For the 2s range, the tolerance for each specification becomes ±10ms.

3) Between contacts of different poles for SDM type only.

PRODUCT TYPE

Type	Operation mode	Contact arrangement	Time range	Protective construction	Rated operating voltage	Terminal type	Part number		
PM4H-SD Star (∧)-Delta (Δ) switching	Star (∧)-Delta (Δ) switching	Relay Timed-out ∧ side: 1 Form A Δ side: 1 Form A	4 selectable ranges over 2s to 100s (∧-Δ switching time: 0.04, 0.1, 0.3, 0.5, 0.7s)	IP65	100 to 240V AC	8 pin	PM4HSD-S-AC240VW		
						screw	PM4HSD-S-AC240VSW		
24V AC		8 pin			PM4HSD-S-AC24VW				
		screw			PM4HSD-S-AC24VSW				
PM4H-SDM Star (∧)-Delta (Δ) switching (Instantaneous contact)		Relay Timed-out ∧ side: 1 Form A Δ side: 1 Form A Instantaneous: 1 Form A					100 to 240V AC	8 pin	PM4HSDM-S-AC240VW
								screw	PM4HSDM-S-AC240VSW
PM4H-SD Star (∧)-Delta (Δ) switching		Relay Timed-out ∧ side: 1 Form A Δ side: 1 Form A					24V AC	8 pin	PM4HSDM-S-AC24VW
								screw	PM4HSDM-S-AC24VSW
PM4H-SDM Star (∧)-Delta (Δ) switching (Instantaneous contact)	Relay Timed-out ∧ side: 1 Form A Δ side: 1 Form A Instantaneous: 1 Form A				100 to 240V AC	8 pin	PM4HSD-S-AC240V		
						screw	PM4HSD-S-AC240VS		
PM4H-SD Star (∧)-Delta (Δ) switching	Relay Timed-out ∧ side: 1 Form A Δ side: 1 Form A				24V AC	8 pin	PM4HSD-S-AC24V		
						screw	PM4HSD-S-AC24VS		
PM4H-SDM Star (∧)-Delta (Δ) switching (Instantaneous contact)	Relay Timed-out ∧ side: 1 Form A Δ side: 1 Form A Instantaneous: 1 Form A				100 to 240V AC	8 pin	PM4HSDM-S-AC240V		
						screw	PM4HSDM-S-AC240VS		
PM4H-SD Star (∧)-Delta (Δ) switching	Relay Timed-out ∧ side: 1 Form A Δ side: 1 Form A				24V AC	8 pin	PM4HSDM-S-AC24V		
						screw	PM4HSDM-S-AC24VS		

When ordering CE type, please order the Part No. with suffix CE. (e.g. PM4HSD-S-AC240VWCE)

WIRING DIAGRAMS

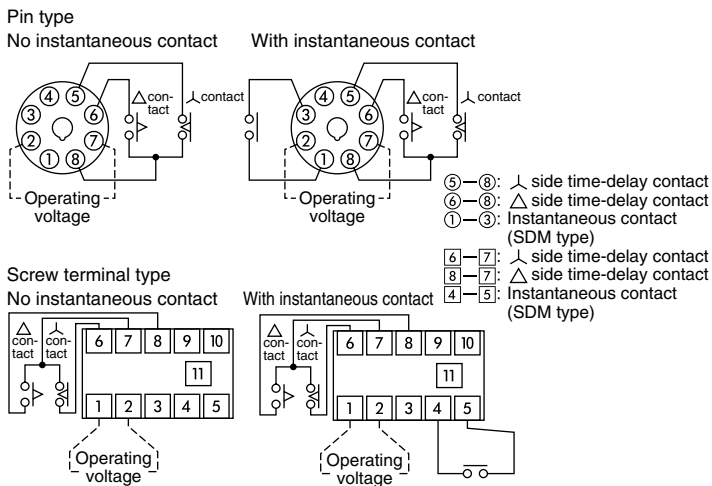

DIMENSIONS

mm inch

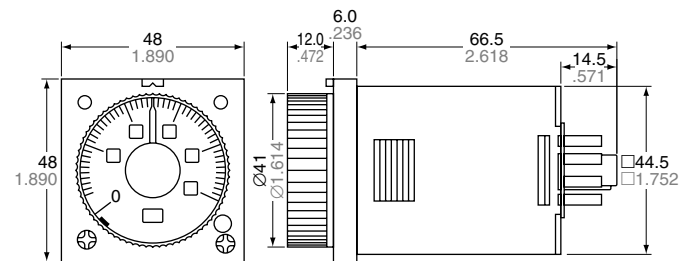

OPERATION MODE

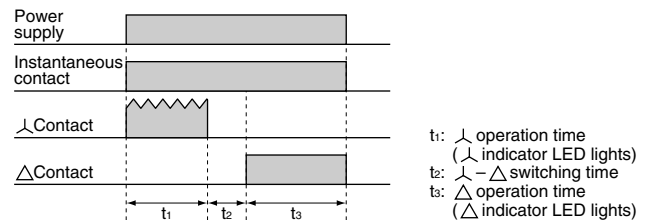

TIME RANGE

Time range	Time range unit	Operating (s)	∧-Δ switching time (s)
2		0.2s to 2s	0.04
10		1s to 10s	0.1
20		2s to 20s	0.3
100		10s to 100s	0.7

	DIN48 SIZE ANALOG MULTIRANGE POWER OFF-DELAY TIMERS	PM4H-F
---	--	---------------

UL File No.: E122222
CSA File No.: LR39291

FEATURES

- Switch operation times between three types of time ranges of 1 s to 10 s and 1 min to 10 min.
- Instantaneous reset available.
- The shorter body makes it easier to use.

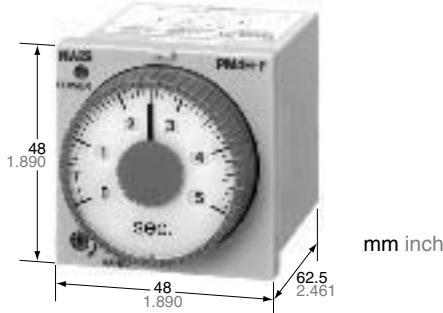

CHARACTERISTICS

Item	Type	PM4H-F8	PM4H-F8R	PM4H-F11R
Rating	Rated operating voltage	100 to 120V AC, 200 to 240V AC, 24V AC, 24V DC, 12V DC		
	Rated frequency	50/60Hz common (AC operating type)		
	Rated power consumption	Approx. 5VA (AC type) Approx. 2W (DC type)		
	Output rating	3A 250V AC (resistive load)		
	Operation mode	Power OFF-delay	Power OFF-delay (with reset)	
	Time range	1s to 10s: 3 range switchable 1 min to 10 min: 3 range selectable		
Time accuracy *1	Operation time fluctuation	±0.3%		
	Setting error	±5% (Full-scale value)		
	Voltage error	±0.5% (at the operating voltage changes between 85 to 110%)		
	Temperature error	±2% (at 20°C ambient temp. at the range of -10 to +50°C +14 to +122°F)		
Contact	Contact arrangement	Timed-out 2 Form C	Timed-out 1 Form C	Timed-out 2 Form C
	Contact resistance (Initial value)	Max. 100mΩ (at 1A 6V DC)		
	Contact material	Au flash on Silver alloy		
Life	Mechanical (contact)	10 ⁷		
	Electrical (contact)	10 ⁵ (at rated control capacity)		
Electrical function	Allowable operating voltage range	85 to 110% of rated operating voltage (at 20°C coil temp.), 90 to 110% (DC Type)		
	Insulation resistance (Initial value)	Min. 100MΩ	Between live and dead metal parts Between input and output Between contacts of different poles *3 (At 500V DC) Between contacts of same pole	
	Breakdown voltage (Initial value)	1,500Vrms for 1 min Between live and dead metal parts 1,500Vrms for 1 min Between input and output 1,000Vrms for 1 min Between contacts of different poles *3 750Vrms for 1 min Between contacts of same pole		
	Min. power supply width	s range type: 100ms min range type: 2s		
	Min. reset time	—	50ms	
	Max. temperature rise	55°C 131°F		
	Mechanical function	Shock resistance	Functional	Min. 98m/s ² (4 times on 3 axes)
Destructive			Min. 980m/s ² (5 times on 3 axes)	
Vibration resistance		Functional	10 to 55Hz: 1 cycle/min double amplitude of 0.5mm (10min on 3 axes)	
		Destructive	10 to 55Hz: 1 cycle/min double amplitude of 0.75mm (1hr on 3 axes)	
Operating condition	Ambient temperature	-10 to +50°C +14 to +122°F		
	Ambient humidity	Max. 85%RH		
	Atmospheric pressure	860 to 1,060hPa		
	Ripple factor (DC type)	20%		
Others	Protective construction	IP65 on front panel (using rubber gasket ATC18002) <only for IP65 type>		
	Weight	100g 3.527 oz (Pin type) 110g 3.880 oz (Screw terminal type)		

*Notes: 1) Unless otherwise specified, the measurement conditions at the maximum scale time standard are specified to be the rated operating voltage (within 5% ripple factor for DC), 20°C 68°F ambient temperature.
 2) For the 1s range, the tolerance for each specification becomes ±10ms. When the power goes on, inrush current (0.3A) flows. Cautions should be taken. The minimum power supplying time after forced reset input is 2s or more.
 3) Between contacts of different pools for F8, F11R types only.

PRODUCT TYPE

Type	Operation mode	Contact arrangement	Time range	Protective construction	Rated operating voltage	Terminal type	Part Number	
PM4H-F8	Power OFF-delay (without reset)	Relay Timed-out 2 Form C	3 selectable ranges over 1s to 10s	IP65	100 to 120V AC	8 pin	PM4HF8-S-AC120VW	
					200 to 240V AC	8 pin	PM4HF8-S-AC240VW	
					24V AC	8 pin	PM4HF8-S-AC24VW	
					12V DC	8 pin	PM4HF8-S-DC12VW	
			24V DC		8 pin	PM4HF8-S-DC24VW		
			100 to 120V AC		8 pin	PM4HF8-M-AC120VW		
			200 to 240V AC		8 pin	PM4HF8-M-AC240VW		
			24V AC		8 pin	PM4HF8-M-AC24VW		
			3 selectable ranges over 1 min to 10 min	IP65	12V DC	8 pin	PM4HF8-M-DC12VW	
					24V DC	8 pin	PM4HF8-M-DC24VW	
					100 to 120V AC	8 pin	PM4HF8-S-AC120V	
					200 to 240V AC	8 pin	PM4HF8-S-AC240V	
			24V AC		8 pin	PM4HF8-S-AC24V		
			12V DC		8 pin	PM4HF8-S-DC12V		
			24V DC		8 pin	PM4HF8-S-DC24V		
			3 selectable time ranges over 1s to 10s		IP50	3 selectable time ranges over 1 min to 10 min	100 to 120V AC	8 pin
200 to 240V AC	8 pin	PM4HF8-M-AC240V						
24V AC	8 pin	PM4HF8-M-AC24V						
12V DC	8 pin	PM4HF8-M-DC12V						
24V DC	8 pin	PM4HF8-M-DC24V						
PM4H-F8R	Power OFF-delay (with instantaneous reset)	Relay Timed-out 1 Form C	3 selectable time ranges over 1s to 10s	IP65		100 to 120V AC	8 pin	PM4HF8R-S-AC120VW
						200 to 240V AC	8 pin	PM4HF8R-S-AC240VW
						24V AC	8 pin	PM4HF8R-S-AC24VW
					12V DC	8 pin	PM4HF8R-S-DC12VW	
			24V DC		8 pin	PM4HF8R-S-DC24VW		
			100 to 120V AC		8 pin	PM4HF8R-M-AC120VW		
			200 to 240V AC		8 pin	PM4HF8R-M-AC240VW		
			24V AC		8 pin	PM4HF8R-M-AC24VW		
			3 selectable time ranges over 1 min to 10 min	IP65	12V DC	8 pin	PM4HF8R-M-DC12VW	
					24V DC	8 pin	PM4HF8R-M-DC24VW	
					100 to 120V AC	8 pin	PM4HF8R-S-AC120V	
					200 to 240V AC	8 pin	PM4HF8R-S-AC240V	
			24V AC		8 pin	PM4HF8R-S-AC24V		
			12V DC		8 pin	PM4HF8R-S-DC12V		
			24V DC		8 pin	PM4HF8R-S-DC24V		
			3 selectable time ranges over 1s to 10s		IP50	3 selectable time ranges over 1 min to 10 min	100 to 120V AC	8 pin
200 to 240V AC	8 pin	PM4HF8R-M-AC240V						
24V AC	8 pin	PM4HF8R-M-AC24V						
12V DC	8 pin	PM4HF8R-M-DC12V						
24V DC	8 pin	PM4HF8R-M-DC24V						

When ordering CE type, please order the Part No. with suffix CE. (e.g. PM4HF8-S-AC120VWCE)

PM4H-F

Type	Operation mode	Contact arrangement	Time range	Protective construction	Rated operating voltage	Terminal type	Part Number
PM4H-F11R	Power OFF-delay (with instantaneous reset)	Relay Timed-out 2 Form C	3 selectable time ranges over 1s to 10s	IP65	100 to 120V AC	11 pin	PM4HF11R-S-AC120VW
						screw	PM4HF11R-S-AC120VSW
					200 to 240V AC	11 pin	PM4HF11R-S-AC240VW
						screw	PM4HF11R-S-AC240VSW
					24V AC	11 pin	PM4HF11R-S-AC24VW
						screw	PM4HF11R-S-AC24VSW
				12V DC	11 pin	PM4HF11R-S-DC12VW	
					screw	PM4HF11R-S-DC12VSW	
				24V DC	11 pin	PM4HF11R-S-DC24VW	
					screw	PM4HF11R-S-DC24VSW	
				IP50	100 to 120V AC	11 pin	PM4HF11R-S-AC120V
						screw	PM4HF11R-S-AC120VS
			200 to 240V AC		11 pin	PM4HF11R-S-AC240V	
					screw	PM4HF11R-S-AC240VS	
			24V AC		11 pin	PM4HF11R-S-AC24V	
					screw	PM4HF11R-S-AC24VS	
			12V DC	11 pin	PM4HF11R-S-DC12V		
				screw	PM4HF11R-S-DC12VS		
			24V DC	11 pin	PM4HF11R-S-DC24V		
				screw	PM4HF11R-S-DC24VS		
			3 selectable time ranges over 1 min to 10 min	IP65	100 to 120V AC	11 pin	PM4HF11R-M-AC120VW
						screw	PM4HF11R-M-AC120VSW
					200 to 240V AC	11 pin	PM4HF11R-M-AC240VW
						screw	PM4HF11R-M-AC240VSW
24V AC	11 pin	PM4HF11R-M-AC24VW					
	screw	PM4HF11R-M-AC24VSW					
12V DC	11 pin	PM4HF11R-M-DC12VW					
	screw	PM4HF11R-M-DC12VSW					
24V DC	11 pin	PM4HF11R-M-DC24VW					
	screw	PM4HF11R-M-DC24VSW					
IP50	100 to 120V AC	11 pin		PM4HF11R-M-AC120V			
		screw		PM4HF11R-M-AC120VS			
	200 to 240V AC	11 pin	PM4HF11R-M-AC240V				
		screw	PM4HF11R-M-AC240VS				
	24V AC	11 pin	PM4HF11R-M-AC24V				
		screw	PM4HF11R-M-AC24VS				
12V DC	11 pin	PM4HF11R-M-DC12V					
	screw	PM4HF11R-M-DC12VS					
24V DC	11 pin	PM4HF11R-M-DC24V					
	screw	PM4HF11R-M-DC24VS					

When ordering CE type, please order the Part No. with suffix CE. (e.g. PM4HF11R-S-AC120VWCE)

DIMENSIONS

• Screw terminal type (embedded mounting)

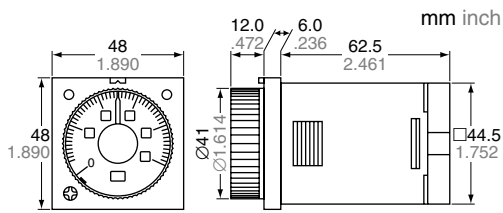

• Pin type (embedded mounting/surface mount)

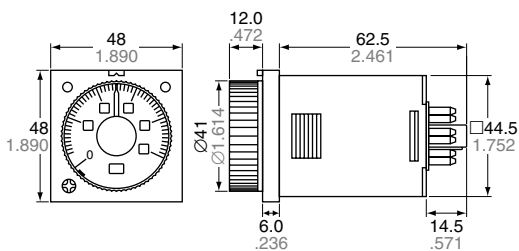

OPERATION

• PM4H-F8 (no reset input)

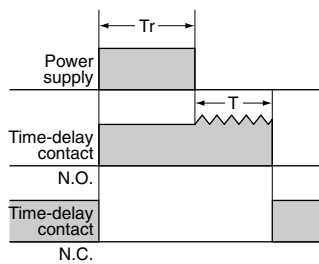

• PM4H-F8R/F11R (with reset input)

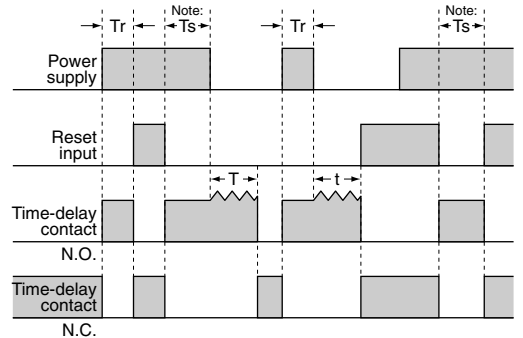

Note: t<T: Time setting
 Tr: Minimum power supply application time
 Ts: Min. 2s (Time to restart operation after reset input is set to OFF: both second type and minute type)

WIRING DIAGRAMS

- **PM4H-F8 (no reset input)**
Pin type
Time-delay 2C

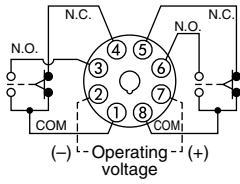

- **PM4H-F8R (with reset input)**
Pin type
Time-delay 1C, with reset input

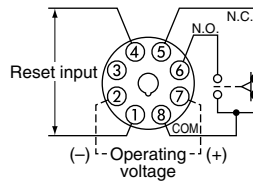

- **PM4H-F11R (with reset input)**
Pin type
Time-delay 2C, with reset input

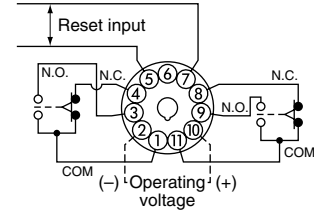

- **Screw terminal type**
Time-delay 2C, with reset input

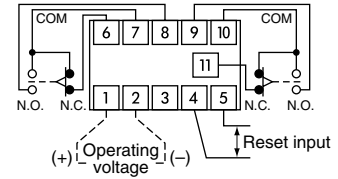

PM4H-F (WITH RESET) INPUT CONDITIONS

1. Contact operating input (pin type example)

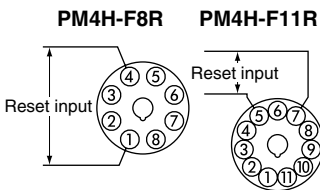

Use a contact with good contact reliability for the input. Contact bounce can lead to erroneous operation of the timer, so use a contact with short bounce time. Make the resistance between terminals for a short circuit less than 1k-ohms. Make the resistance between terminals for an open circuit greater than 100k-ohms.

2. Non-contact input (pin type example)

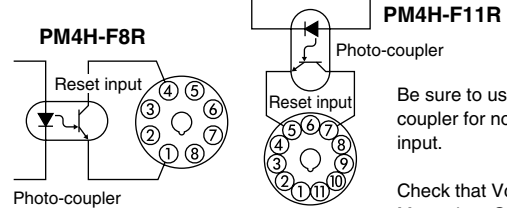

Be sure to use a photo-coupler for non-contact input.

Check that $V_{ce} = 0.6V$ Max. when ON.

TIME RANGE

Time range unit	s range type	min range type
1	0.04s to 1s	0.04 min to 1 min
5	0.2s to 5s	0.2 min to 5 min
10	0.4s to 10s	0.4 min to 10 min

Notes for PM4H series

MODES & TIME SETTING

1) Operation mode setting [PM4H-A]

8 operation modes are selectable with operation mode selector.
Turn the operation mode selector with screw driver.
Operation mode is shown up through the window above the mode selector. The marks are (M), (L), (D), (F), (S), (OS), (P), (C).
Turn the mode selector to the mark until you can check by clicking sound.
Confirm the mode selector position if it is correct.
If the position is not stable, the timer might mis-operate.



2) Time setting [common]

16 time ranges are selectable between 1s to 500h.
Turn the time range selector with the screw driver.
Clockwise turning increases the time range, and Counter-clockwise turning decrease the time range.
Confirm the range selector position if it is correct.



3) Time setting [common]

To set the time, turn the set dial to a desired time within the range.
Instantaneous output will be on when the dial is set to "0".
When the instantaneous output is used, the dial should be set under "0" range. (Instantaneous output area)
When power supply is on, the time range, setting time and operation mode cannot be changed.
Turn off the power supply or a reset signal is applied to set the new operation mode.

How to use "Stop ring" [PM4H series]

1) Fixed time setting

Set the desired time and put 2 stop rings together.
Insert the rings into stopper to fix the time.

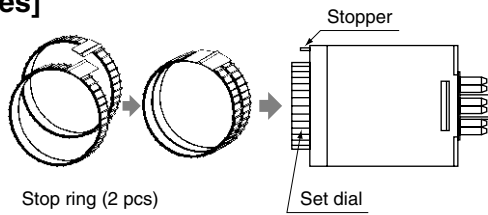

2) Fixed time range setting

Example: Time range 20s to 30s.

① Shorter time value setting

Set the dial to 20s.
Place the stop ring at the right side of stopper.

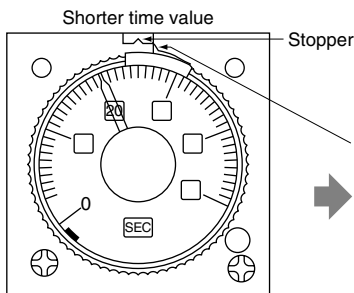

② Longer time value setting

Set the dial to 30s.
Place the stop ring at the left side of stopper.

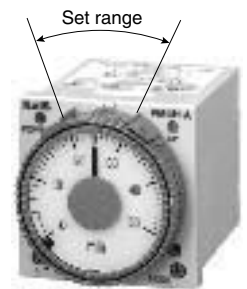
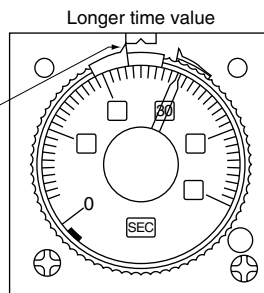

DATA

■ Load control life

• Load life curve (PM4H-A, PM4H-S, PM4H-W)

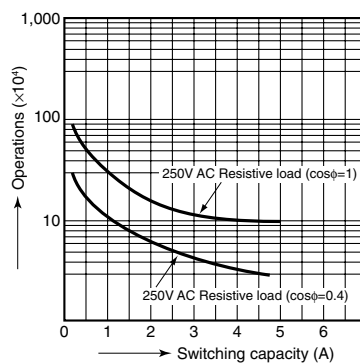

• Load life curve (PM4H-M)

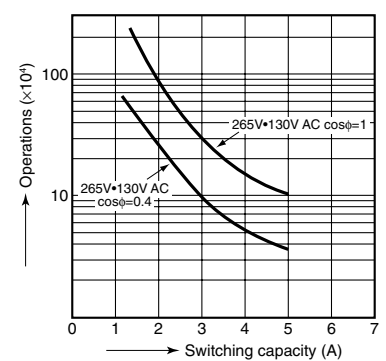

CAUTIONS

1. Terminal connections

- 1) Refer to wiring diagram before terminal connections.
- 2) Use the screw terminal type for flush mounting.
For using 8 pin type, use the timer with screw terminal socket (AT8-RR) or 8 pin cap (AD8-RC).
For using 11 pin type, use the timer with 11 pin cap (AT8-DP11).
Do not solder directly the pin of the timer for connection.
- 3) The connection to power supply

100 to 240V AC, 24V AC type

Type	Pin	Screw terminal
PM4H-A PM4H-F11R	Connect the terminal ②-⑩ to the power source.	Connect the terminal z-x to the power source.
PM4H-S PM4H-M PM4H-W PM4H-SD PM4H-F8 PM4H-F8R	Connect the terminal ②-⑦ to the power source.	

DC type

Type	Pin	Screw terminal
PM4H-A PM4H-F11R	Connect the terminal ② to negative (-), the terminal ⑩ to positive (+).	Connect the terminal x to negative (-), the terminal z to positive (+).
PM4H-S PM4H-M PM4H-W PM4H-F8 PM4H-F8R	Connect the terminal ② to negative (-), the terminal ⑦ to positive (+).	

Prevent inductive or residual voltages generating between the power supply terminals after the power is off.
(If the power supply cables are routed parallel to the high voltage or power cables, an inductive voltage will be generated between the power supply terminals.)

- On the DC type, keep the voltage within the allowable operating voltage range with ripple rate of 20% or less.
Apply the power supply voltage at once through the switch or relay contacts. If the voltage is gradually applied, the timer may time up or power supply reset may not operate regardless of setting time.
- 4) The control output load must be less than the rated load capacity of the relay contacts.

2. Input connections

1) If the circuit is connected as in Fig. A, the internal circuits must be broken. Be sure to connect the circuit as in Fig. B. Especially, for customer who has been used PM48A (Conventional type), be sure to check if the new circuit for PM4H timer is corrected as in Fig. B.

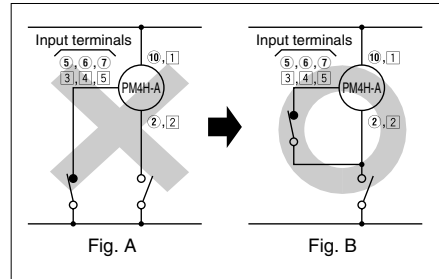

- 2) Since the PM4H timers use a transformerless power supply system, the input equipment must use the power supply transformer in which the secondary side is not grounded with the primary and secondary sides insulated, in order to prevent interference of the power supply circuit when connecting the external input circuit.
Be sure not to use an autotransformer.
- 3) Be sure not to use terminal ⑩ as the common terminal of the operation signal as shown in Fig. A. Otherwise, the internal circuit of the timer may be damaged. Use terminal ② as the common terminal as shown in Fig. B.

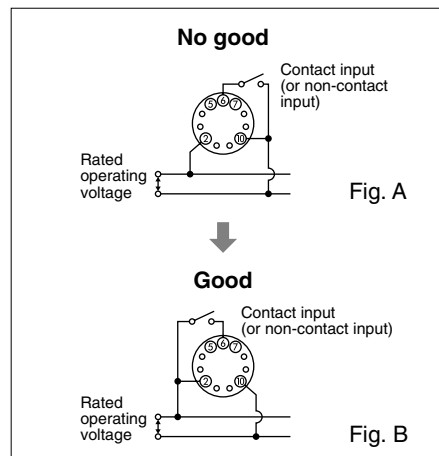

- 4) When one input signal is simultaneously applied to more than one timer, be sure to avoid the wiring shown in Fig. C. Otherwise, the short-circuit current will flow and cause damage. Be sure to align the polarity of the power supply as shown in Fig. D.

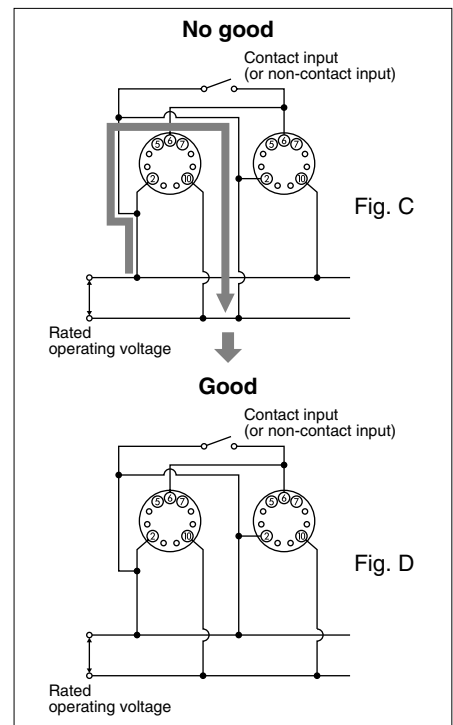

- 5) Terminal ②-⑥ (screw terminal ②-③) should be connected as the operation signal input. Connect terminals ②-⑦ (screw terminal ②-④) for reset signal input. Connect terminals ②-⑤ (screw terminal ②-⑤) for stop signal input. Be sure not to connect with other terminals and apply excessive voltage. The internal circuit will be damaged.
- 6) The input wiring other than the power supply circuit should avoid these conditions, high-voltage wiring and parallel wiring with power wire. Wire in short with using the sealed-wire or metal wiring tube.
- 7) For operation signal, reset and stop input, use gold-plated contact with high reliability. Since contact bouncing causes errors in the operation, use an input contact less bounce time.
- 8) Keep the minimum signal input time over 0.05 s.

3. Input signal conditions

- 1) Connections of contact input

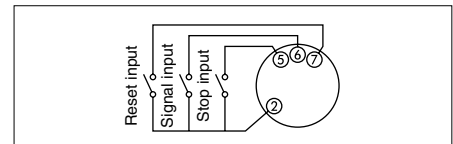

Use gold-plated contacts with high-reliability. The bounce time at the contacts causes errors in the timer operation time. Accordingly, use signal input contact whose bounce time is short. The resistance when shorted should be less than 1kΩ, and when open resistance should be more than 100kΩ.

Notes for PM4H series

2) Connections of non-contact input (open-collector)

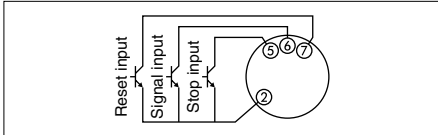

Apply the open-collector connection. The characteristics of the transistor used must be $V_{CE0}=10V$ or more, $I_C=10mA$ or more, and $I_{CBO}=6\mu A$ or less. Additionally, the input impedance must be $1k\Omega$ or less, and the residual voltage must be $0.6V$ or less.

3) Voltage input

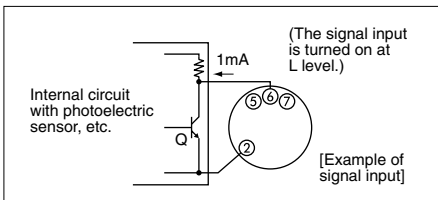

Even if the open collector is not used, input is also possible from the non-contact circuit of 6 to 30V DC. In this case, the signal input is turned on when the signal is turned from H to L. The residual voltage must be $0.6V$ or less when Q is on. On the AC type, an insulated transformer is required as the power supply for the photoelectric sensor, etc. (power supply for the input devices).

Note: Keep the minimum input signal time of each signal to 0.05s or more.

4. Power off time

Keep 0.1s (-A, -S, -M type), 0.5s (-SD/SDM type), 0.3s (-W type) or more for the power off time after time cycle is completed.

5. Cautions [Common]

1. Prevent using the timer in such places where flammable or corrosive gas is generated, a lot of dust exists, oil is splashed or considerable shock and vibration occur.
2. Since the main body cover is made of polycarbonate resin, prevent contact with organic solvents such as methyl alcohol, benzene and thinner, or strong alkali materials such as ammonia and caustic soda.
3. External surge protection may be required if the following values are exceeded. Otherwise, the internal circuit will be damaged.

Operation voltage	Surge voltage
100 to 240V AC 100 to 120V AC 200 to 240V AC 48 to 125V DC	4,000V
12V DC, 24V DC 24V AC 24V AC/DC	500V

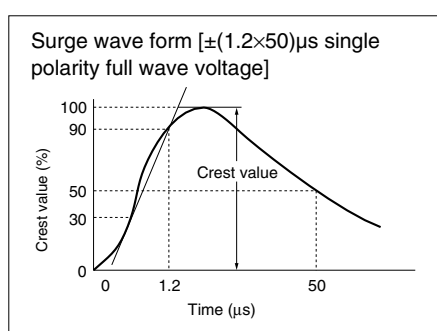

4. For connecting and disconnecting operating voltage to the timer, a circuit should be used to prevent the flow of leakage current. For example, a circuit for contact protection as shown in Fig. A will permit leakage current to flow through R and C, causing erroneous operation of the timer. Instead, the circuit shown in Fig. B should be used.

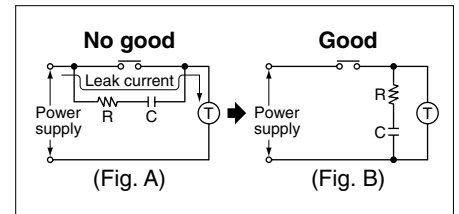

5. In order to maintain the characteristics of the timer, long continuous current flow through the timer, causing generation of heat internally should be avoided because of the degradation it can cause. For such long continuous operation, the circuit shown below should be used.

