

UL File No.: E122222  
CSA File No.: LR39291

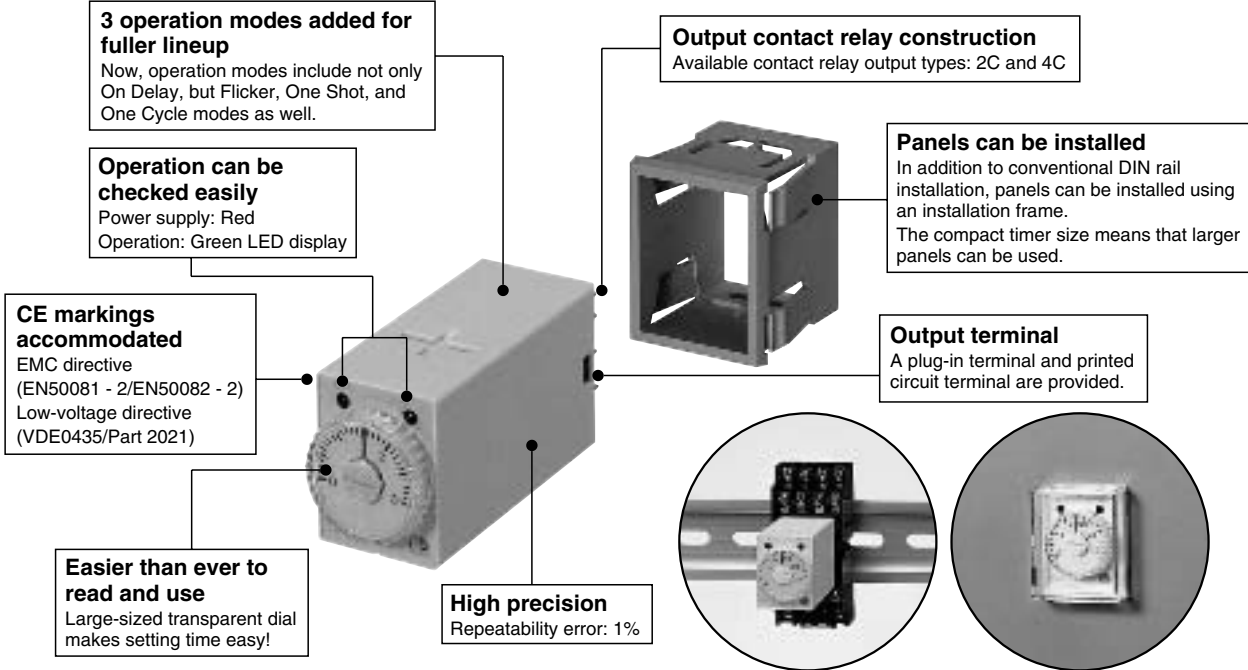

**Features**



**Product types**

• **Plug-in terminal**

Power ON-delay  
AC operating type

	Time range	24V AC	100 to 120V AC	200 to 220V AC	220 to 240V AC
		Part number	Part number	Part number	Part number
<b>Time-out 2 Form C type</b>	0.05 to 0.5 s	S1DX-A2C0.5S-AC24V	S1DX-A2C0.5S-AC120V	S1DX-A2C0.5S-AC220V	S1DX-A2C0.5S-AC240V
	0.1 to 1 s	S1DX-A2C1S-AC24V	S1DX-A2C1S-AC120V	S1DX-A2C1S-AC220V	S1DX-A2C1S-AC240V
	0.1 to 3 s	S1DX-A2C3S-AC24V	S1DX-A2C3S-AC120V	S1DX-A2C3S-AC220V	S1DX-A2C3S-AC240V
	0.2 to 5 s	S1DX-A2C5S-AC24V	S1DX-A2C5S-AC120V	S1DX-A2C5S-AC220V	S1DX-A2C5S-AC240V
	0.5 to 10 s	S1DX-A2C10S-AC24V	S1DX-A2C10S-AC120V	S1DX-A2C10S-AC220V	S1DX-A2C10S-AC240V
	1 to 30 s	S1DX-A2C30S-AC24V	S1DX-A2C30S-AC120V	S1DX-A2C30S-AC220V	S1DX-A2C30S-AC240V
	3 to 60 s	S1DX-A2C60S-AC24V	S1DX-A2C60S-AC120V	S1DX-A2C60S-AC220V	S1DX-A2C60S-AC240V
	0.1 to 3 min	S1DX-A2C3M-AC24V	S1DX-A2C3M-AC120V	S1DX-A2C3M-AC220V	S1DX-A2C3M-AC240V
	0.5 to 10 min	S1DX-A2C10M-AC24V	S1DX-A2C10M-AC120V	S1DX-A2C10M-AC220V	S1DX-A2C10M-AC240V
	1 to 30 min	S1DX-A2C30M-AC24V	S1DX-A2C30M-AC120V	S1DX-A2C30M-AC220V	S1DX-A2C30M-AC240V
<b>Time-out 4 Form C type</b>	0.05 to 0.5 s	S1DX-A4C0.5S-AC24V	S1DX-A4C0.5S-AC120V	S1DX-A4C0.5S-AC220V	S1DX-A4C0.5S-AC240V
	0.1 to 1 s	S1DX-A4C1S-AC24V	S1DX-A4C1S-AC120V	S1DX-A4C1S-AC220V	S1DX-A4C1S-AC240V
	0.1 to 3 s	S1DX-A4C3S-AC24V	S1DX-A4C3S-AC120V	S1DX-A4C3S-AC220V	S1DX-A4C3S-AC240V
	0.2 to 5 s	S1DX-A4C5S-AC24V	S1DX-A4C5S-AC120V	S1DX-A4C5S-AC220V	S1DX-A4C5S-AC240V
	0.5 to 10 s	S1DX-A4C10S-AC24V	S1DX-A4C10S-AC120V	S1DX-A4C10S-AC220V	S1DX-A4C10S-AC240V
	1 to 30 s	S1DX-A4C30S-AC24V	S1DX-A4C30S-AC120V	S1DX-A4C30S-AC220V	S1DX-A4C30S-AC240V
	3 to 60 s	S1DX-A4C60S-AC24V	S1DX-A4C60S-AC120V	S1DX-A4C60S-AC220V	S1DX-A4C60S-AC240V
	0.1 to 3 min	S1DX-A4C3M-AC24V	S1DX-A4C3M-AC120V	S1DX-A4C3M-AC220V	S1DX-A4C3M-AC240V
	0.5 to 10 min	S1DX-A4C10M-AC24V	S1DX-A4C10M-AC120V	S1DX-A4C10M-AC220V	S1DX-A4C10M-AC240V
	1 to 30 min	S1DX-A4C30M-AC24V	S1DX-A4C30M-AC120V	S1DX-A4C30M-AC220V	S1DX-A4C30M-AC240V
3 to 60 min	S1DX-A4C60M-AC24V	S1DX-A4C60M-AC120V	S1DX-A4C60M-AC220V	S1DX-A4C60M-AC240V	
0.1 to 3 h	S1DX-A4C3H-AC24V	S1DX-A4C3H-AC120V	S1DX-A4C3H-AC220V	S1DX-A4C3H-AC240V	

\* Wire springs (ADX18005) are included.

DC operating type

	Time range	12V DC	24V DC
		Part number	Part number
Time-out 2 Form C type	0.05 to 0.5 s	S1DX-A2C0.5S-DC12V	S1DX-A2C0.5S-DC24V
	0.1 to 1 s	S1DX-A2C1S-DC12V	S1DX-A2C1S-DC24V
	0.1 to 3 s	S1DX-A2C3S-DC12V	S1DX-A2C3S-DC24V
	0.2 to 5 s	S1DX-A2C5S-DC12V	S1DX-A2C5S-DC24V
	0.5 to 10 s	S1DX-A2C10S-DC12V	S1DX-A2C10S-DC24V
	1 to 30 s	S1DX-A2C30S-DC12V	S1DX-A2C30S-DC24V
	3 to 60 s	S1DX-A2C60S-DC12V	S1DX-A2C60S-DC24V
	0.1 to 3 min	S1DX-A2C3M-DC12V	S1DX-A2C3M-DC24V
	0.5 to 10 min	S1DX-A2C10M-DC12V	S1DX-A2C10M-DC24V
	1 to 30 min	S1DX-A2C30M-DC12V	S1DX-A2C30M-DC24V
Time-out 4 Form C type	0.05 to 0.5 s	S1DX-A4C0.5S-DC12V	S1DX-A4C0.5S-DC24V
	0.1 to 1 s	S1DX-A4C1S-DC12V	S1DX-A4C1S-DC24V
	0.1 to 3 s	S1DX-A4C3S-DC12V	S1DX-A4C3S-DC24V
	0.2 to 5 s	S1DX-A4C5S-DC12V	S1DX-A4C5S-DC24V
	0.5 to 10 s	S1DX-A4C10S-DC12V	S1DX-A4C10S-DC24V
	1 to 30 s	S1DX-A4C30S-DC12V	S1DX-A4C30S-DC24V
	3 to 60 s	S1DX-A4C60S-DC12V	S1DX-A4C60S-DC24V
	0.1 to 3 min	S1DX-A4C3M-DC12V	S1DX-A4C3M-DC24V
	0.5 to 10 min	S1DX-A4C10M-DC12V	S1DX-A4C10M-DC24V
	1 to 30 min	S1DX-A4C30M-DC12V	S1DX-A4C30M-DC24V
3 to 60 min	S1DX-A4C60M-DC12V	S1DX-A4C60M-DC24V	
0.1 to 3 h	S1DX-A4C3H-DC12V	S1DX-A4C3H-DC24V	

\* Wire springs (ADX18005) are included.

Please select power flicker, power one-shot or power one-cycle specifications based on the ordering information listed below.

ORDERING INFORMATION

Ex. S1DX- **C** **2C** **5S** — **AC120V**

Operation mode	Control output arrangement	Time range *		Operating voltage *
F: Power Flicker S: Power One-shot C: Power One-cycle	2C: Timed-out 2 Form C 4C: Timed-out 4 Form C	0.5S: 0.05 to 0.5 s 1S: 0.1 to 1 s 3S: 0.1 to 3 s 5S: 0.2 to 5 s 10S: 0.5 to 10 s 30S: 1 to 30 s	60S: 3 to 60 s 3M: 0.1 to 3 min 10M: 0.5 to 10 min 30M: 1 to 30 min 60M: 3 to 60 min 3H: 0.1 to 3 h	AC24V: 24V AC AC120V: 100 to 120V AC AC220V: 200 to 220V AC AC240V: 220 to 240V AC DC12V: 12V DC DC24V: 24V DC

\*For other time range types and operating voltage types, please consult us.

• PC board terminal

Power ON-delay

	Time range	100 to 120V AC	200 to 220V AC	24V DC
		Part number	Part number	Part number
Time-out 2 Form C type	0.05 to 0.5 s	S1DX-A2C0.5S-AC120VP	S1DX-A2C0.5S-AC220VP	S1DX-A2C0.5S-DC24VP
	0.1 to 1 s	S1DX-A2C1S-AC120VP	S1DX-A2C1S-AC220VP	S1DX-A2C1S-DC24VP
	0.1 to 3 s	S1DX-A2C3S-AC120VP	S1DX-A2C3S-AC220VP	S1DX-A2C3S-DC24VP
	0.2 to 5 s	S1DX-A2C5S-AC120VP	S1DX-A2C5S-AC220VP	S1DX-A2C5S-DC24VP
	0.5 to 10 s	S1DX-A2C10S-AC120VP	S1DX-A2C10S-AC220VP	S1DX-A2C10S-DC24VP
	1 to 30 s	S1DX-A2C30S-AC120VP	S1DX-A2C30S-AC220VP	S1DX-A2C30S-DC24VP
	3 to 60 s	S1DX-A2C60S-AC120VP	S1DX-A2C60S-AC220VP	S1DX-A2C60S-DC24VP
Time-out 4 Form C type	0.05 to 0.5 s	S1DX-A4C0.5S-AC120VP	S1DX-A4C0.5S-AC220VP	S1DX-A4C0.5S-DC24VP
	0.1 to 1 s	S1DX-A4C1S-AC120VP	S1DX-A4C1S-AC220VP	S1DX-A4C1S-DC24VP
	0.1 to 3 s	S1DX-A4C3S-AC120VP	S1DX-A4C3S-AC220VP	S1DX-A4C3S-DC24VP
	0.2 to 5 s	S1DX-A4C5S-AC120VP	S1DX-A4C5S-AC220VP	S1DX-A4C5S-DC24VP
	0.5 to 10 s	S1DX-A4C10S-AC120VP	S1DX-A4C10S-AC220VP	S1DX-A4C10S-DC24VP
	1 to 30 s	S1DX-A4C30S-AC120VP	S1DX-A4C30S-AC220VP	S1DX-A4C30S-DC24VP
	60 s	S1DX-A4C60S-AC120VP	S1DX-A4C60S-AC220VP	S1DX-A4C60S-DC24VP

\* Wire springs (ADX18005) are included.

# Specifications

Type		AC operating type	DC operating type
Rated operating voltage		24V, 100 to 120V, 200 to 220V, 220 to 240V	12V, 24V
Allowable operating voltage range		80 to 110% of rated operating voltage	
Rated frequency		50/60Hz common	—
Power supply ripple		—	Full-wave rectified (Approx. 48%)
Rated power consumption		Max. 3VA	Max. 2W
Rated control capacity		[Timed-out 2 Form C]: 7A 250V AC [Timed-out 4 Form C]: 5A 250V AC (resistive load)	
UL/CSA rating		[Timed-out 2 Form C]: 7A 125 AC, 6A 250V AC, 1/6HP 125, 250V AC, PILOT DUTY C300 [Timed-out 4 Form C]: 5A 250V AC, 1/10HP 125, 250V AC, PILOT DUTY C300	
Output arrangement		Timed-out 2 Form C, Timed-out 4 Form C	
Time accuracy (max.)	Operating time fluctuation & Power off time change error	[Except 0.5s & 1s types] ±1% [0.5s type]: ±(2%+10ms) [1s type]: ±(1%+10ms) (power off time change at the range of 0.1 s to 1 h)	
	Temperature error	±5% (at 20°C ambient temp. at the range of -10 to +50°C +14 to +122°F)	
	Voltage error	[Except 0.5s & 1s types] ±1% [0.5s type]: ±(2%+10ms) [1s type]: ±(1%+10ms) (at the operating voltage changes between -20 to +10%)	
	Setting error	±10% (Full-scale value)	
Min. power off time		100ms	
Contact resistance (Initial value)		Max. 100mΩ (at 1A, 6V DC)	
Life	Mechanical (constant)	10 <sup>7</sup>	
	Electrical (constant)	2×10 <sup>5</sup> (at rated control capacity)	
Insulation resistance (Initial value)		Min. 100MΩ Between live and dead metal parts/input and output Between contact sets (At 500V DC) Between contacts	
Breakdown voltage (Initial value)		1500Vrms for 1min Between live and dead metal parts/input and output 1500Vrms for 1min Between contact sets 1000Vrms for 1min Between contacts	
Vibration resistance	Functional	10 to 55Hz: 1 cycle/min double amplitude of 0.5mm (10min on 3 axes)	
	Destructive	10 to 55Hz: 1 cycle/min double amplitude of 0.75mm (1h on 3 axes)	
Shock resistance	Functional	Min. 98m/s <sup>2</sup> (4 times on 3 axes)	
	Destructive	Min. 980m/s <sup>2</sup> (5 times on 3 axes)	
Max. temperature rise		70°C 158°F	
Ambient temperature		-10 to 50°C + 14 to 122°F	
Ambient humidity		Max. 85% RH	

\*Power one-shot type of 1 s type: +(2% + 10 ms)

# Dimensions

mm inch

## • Plug-in terminal

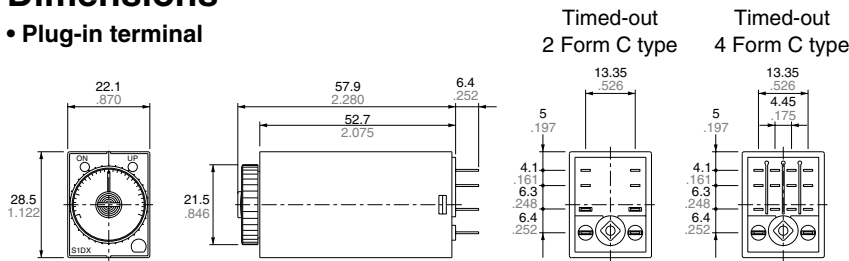

## • Printed circuit board terminal

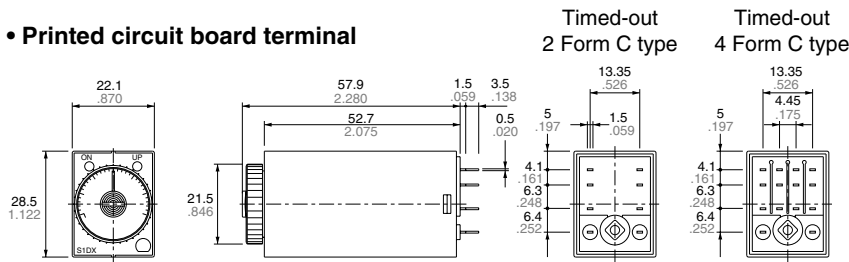

# Terminal layouts and Wiring diagram

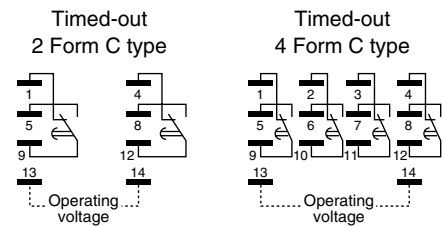

(For the DC operating type, terminal 14 is +, and terminal 13 is -)

# PC board pattern

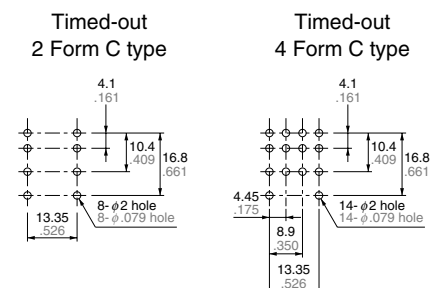

## Data

### 1. Load control capacity and life

#### • Switching capacity

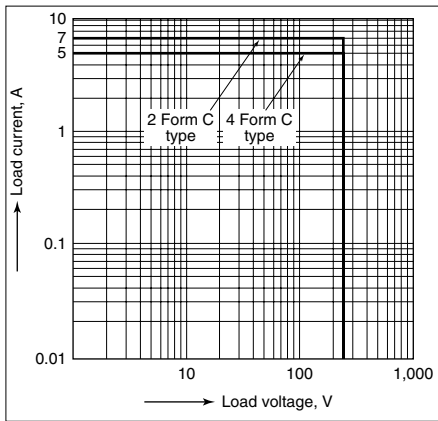

#### • Life curve

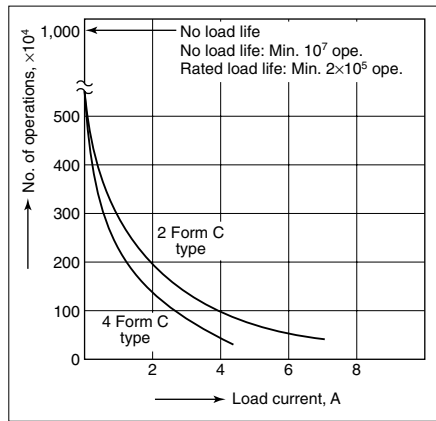

### 2. Time accuracy

#### • Voltage error test I

3 s range, 120V AC operating type 6 pcs.

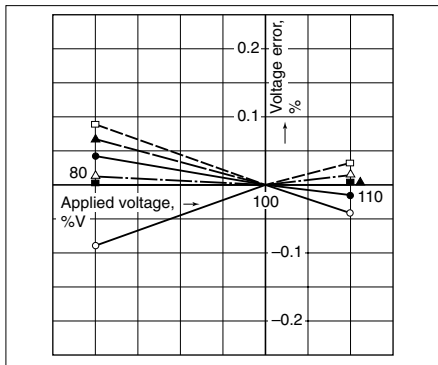

#### • Voltage error test II

3 s range, 220V AC operating type 3 pcs.

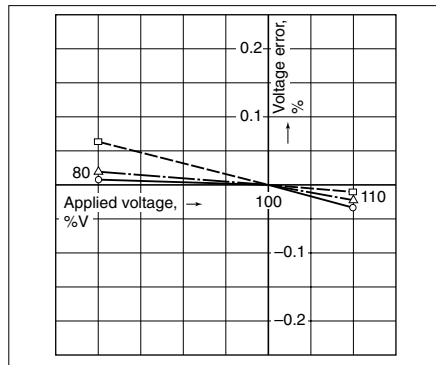

#### • Voltage error test III

3 s range, 24V DC operating type 3 pcs.

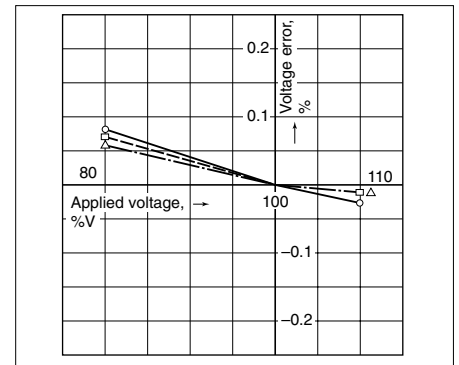

#### • Temperature error test I

3 s range, 120V AC operating type 4 pcs.

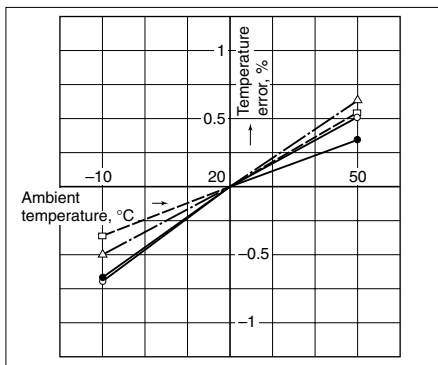

#### • Temperature error test II

3 s range, 220V AC operating type 4 pcs.

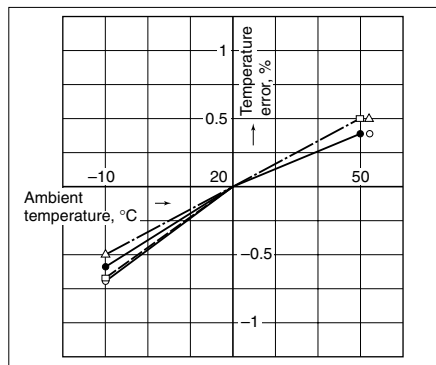

#### • Temperature error test III

3 s range, 24V DC operating type 3 pcs.

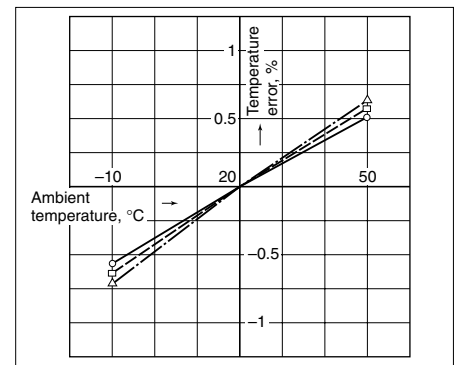

### 3. Environmental durability

#### • Surge testing

Model	100 to 120V AC	200 to 220V AC	12V DC	24V DC	48V DC	100 to 120V DC
Surge voltage	4,000V	4,000V	1,000V	1,000V	4,000V	4,000V

Applied voltage: Unipolar full-wave voltage of  $\pm (1.2 \times 50) \mu\text{s}$

No. of times applied: 5 times, continuously

Locations at which voltage is applied:

Between power supply terminals (between 13 and 14)

Results: No differences from withstand surge voltages listed above.

#### • Noise testing

Item	Noise generation	Results
Power supply weight Noise	Noise simulator 1,000 V Rise: 1 ns Pulse width: 1 (s, 50 ns) Repetition cycle: 10 ms Pulse polarity: Positive, negative Applied modes: Normal mode and Common mode	Not affected

#### • Cold and heat testing

Conditions	Results
Left for 1 hour at high temperature of 80°C (176°F) and low temperature of -25°C (-13°F) (25 times)	Appearance Operation Insulation performance —No irregularities

#### • Humidity testing

Conditions	Results
Left for 500 hours at ambient temperature of 40 (C, at relative humidity of 90 to 95%.	Appearance Operation Insulation performance —No irregularities

## Operation mode and color

## Scale intervals

Operation type	Description	Time chart	Operation mode indicator color
<b>Power ON-delay</b>	Timing operation will start when the power is supplied, and the control output turns on after the setting time.		Yellow
<b>Power Flicker</b>	When the power is supplied, the control output turns on after the setting time and then turns off after the setting time. This operation is repeated sequentially.		Blue
<b>Power One-shot</b>	When the power is supplied, control output turns on for the setting time.		Green
<b>Power One-cycle</b>	When the power is supplied, the control output turns on for one pulse after the setting time.		Red

Time type	Scale intervals
0.5	0.05 (0.02 in a range of 0.1 to 0.5)
1	0.05
3	0.1
5	0.2
10	0.5
30	1
60	2

## Accessory

mm inch

### • Mounting frame



ADX18002 Titan Gray  
ADX18006 Gray  
ADX18007 Black

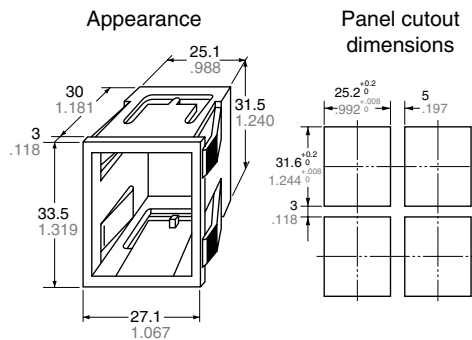

### • Protective cover

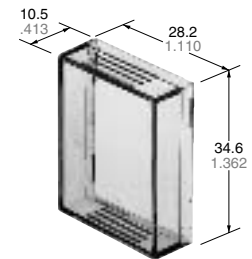

ADX18008

### • Socket

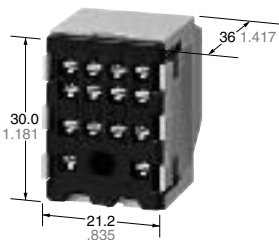

ADX18011

### • Cap



ADX18004

### • Socket

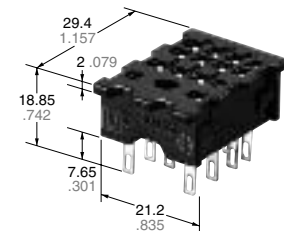

ADX18003

## • Applicable socket leaf holding clip for S1DX

Part number	ADX18001 Dimensions	Installation overall height	Applicable terminal socket
 (2 pcs. per set)		About 88 mm 3.465 inch	HC2-SFD-K HC4-SFD-K

## Terminal socket

- HC2 slim DIN terminal socket
- HC2 DIN high terminal socket
- HC4 DIN high terminal socket
- HC4 socket

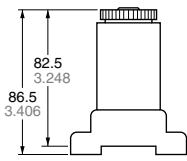

HC2-SFD-S

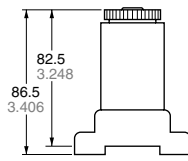

HC2-SFD-K

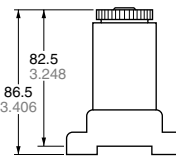

HC4-SFD-K

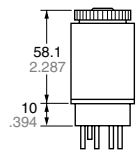

HC4-SS-K

For more information regarding the socket, refer to page "S1DX TIMER OPTIONS".

## Precautions during usage

### 1. Terminal wiring

Make sure that terminals are wired carefully and correctly, referring to the terminal layout and wiring diagrams.

### 2. Assembly

- 1) A dedicated terminal base or socket should be used for attachment.
- 2) To assure that characteristics are maintained, do not remove the case.

### 3. Rest periods

After unscheduled operations have been completed, or if the timer operation power supply has been turned off at any time during operation, a rest period of at least 0.1 seconds should be allowed before resuming operation.

4. External surge protection may be required if the following values are exceeded. Otherwise, the internal circuit will be damaged.

Operation voltage	Surge voltage
100 to 120V AC 200 to 220V AC 220 to 240V AC	4,000V
24V AC 12V DC 24V DC	1,000V

### • Single-pole, full-wave voltage for surge waveform [ $\pm(1.2 \times 50) \mu\text{s}$ ]

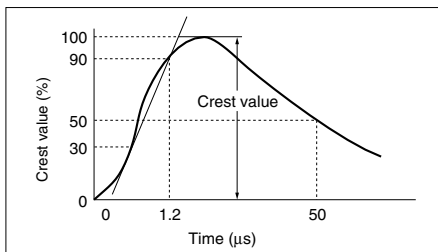

The typical surge absorption elements include a varistor, a capacitor, and a diode. If a surge absorption element is used, use an oscilloscope to see whether or not the foreign surge exceeding the specified value appears.

### 5. Phase synchronization using AC load

If the turning on of the timer output relay is synchronized to the AC power supply phase, there may be times when the service life is shortened because of electrical factors, or when a locking phenomenon (defective relay return) occurs because of contact point welding or a shift in the contact relay. Check the operation using the actual timer.

### 6. Soldering and cleaning

- 1) A flux-tight construction is not used with this timer, so be careful that flux does not get inside the case.
- 2) Terminals should be soldered by hand (at a soldering iron temperature of 300°C 572°F, for less than 3 seconds, using a 30 to 60 W soldering iron). Automatic soldering should be avoided.

- 3) Cleaning should be avoided as much as possible. If the timer has to be cleaned, make sure no cleaning fluid gets inside the main unit case.

### 7. Others

- 1) When connecting the operating power supply, make sure that no leakage current enters the timer. For example, when performing contact protection, if set up like that of fig. A, leaking current will pass through C and R, enter the unit, and cause incorrect operation. The fig. B shows the correct setup.

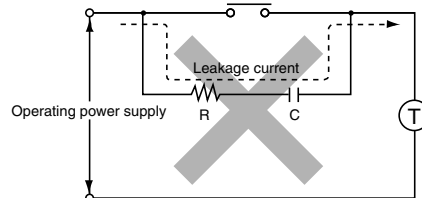

(Fig. A)

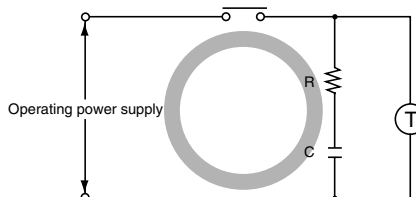

(Fig. B)

When a contact switch having an operation indicating lamp (lamp equipped limit switch, etc.) is used to apply power to the timer, a resistor having a value equal to or greater than the value below shall be connected in series with the lamp.

- 100 to 120V AC operating type: Min. 33kΩ
- 200 to 220V AC operating type: Min. 82kΩ
- 220 to 240V AC operating type: Min. 82kΩ

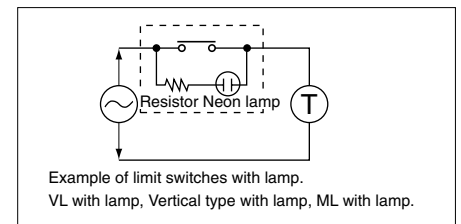

- 2) When setting the time, the dial should be kept within the range indicated on the dial face. The "0" marking on the dial indicates the minimum time during which the control time can be varied (it does not indicate 0 seconds).