



Contactors, 380 V 400 V 30 kW, 2 N/O, 2 NC, 400 V 50 Hz, 440 V 60 Hz, AC operation, Screw terminals

Part no. DILM65-22(400V50HZ,440V60HZ)
Catalog No. 277928
Alternate Catalog No. XTCE065D22I3

Delivery program

Product range			Contactors
Application			Contactors for Motors
Subrange			Complete devices up to 170 A
Utilization category			AC-1: Non-inductive or slightly inductive loads, resistance furnaces AC-3/AC-3e: Normal AC induction motors: Starting, switching off while running AC-4: Normal AC induction motors: starting, plugging, reversing, inching
Connection technique			Screw terminals
Notes			 Also suitable for motors with efficiency class IE3. Also tested according to AC-3e.

Rated operational current

AC-3			
380 V 400 V	I_e	A	65
AC-1			
Conventional free air thermal current, 3 pole, 50 - 60 Hz			
Open			
at 40 °C	$I_{th} = I_e$	A	98
enclosed	I_{th}	A	72
Conventional free air thermal current, 1 pole			
open	I_{th}	A	200
enclosed	I_{th}	A	180

Max. rating for three-phase motors, 50 - 60 Hz

AC-3			
220 V 230 V	P	kW	20
380 V 400 V	P	kW	30
660 V 690 V	P	kW	35
AC-4			
220 V 230 V	P	kW	7
380 V 400 V	P	kW	12
660 V 690 V	P	kW	17

Contacts

N/O = Normally open			2 N/O
N/C = Normally closed			2 NC

Instructions

Contacts to EN 50 012. with mirror contact.

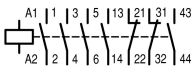
Contact sequence			
------------------	--	--	--

Actuating voltage	400 V 50 Hz, 440 V 60 Hz		
Voltage AC/DC	AC operation		

Technical data

General

Standards	IEC/EN 60947, VDE 0660, UL, CSA		
Lifespan, mechanical			

AC operated	Operations	x 10 ⁶	10
Operating frequency, mechanical			
AC operated	Operations/h		5000
Climatic proofing			
Damp heat, constant, to IEC 60068-2-78 Damp heat, cyclic, to IEC 60068-2-30			
Ambient temperature			
Open		°C	-25 - +60
Enclosed		°C	- 25 - 40
Storage		°C	- 40 - 80
Mounting position			
Mechanical shock resistance (IEC/EN 60068-2-27)			
Half-sinusoidal shock, 10 ms			
Main contacts			
N/O contact		g	10
Auxiliary contacts			
N/O contact		g	7
N/C contact		g	5
Mechanical shock resistance (IEC/EN 60068-2-27) when tabletop-mounted			
Half-sinusoidal shock, 10 ms			
Main contacts			
N/O contact		g	10
Auxiliary contacts			
N/O contact		g	7
N/C contact		g	5
Degree of Protection			
IP00			
Protection against direct contact when actuated from front (EN 50274)			
Finger and back-of-hand proof			
Altitude			
m			
Max. 2000			
Weight			
AC operated		kg	0.922
Screw connector terminals			
Terminal capacity main cable			
Solid		mm ²	1 x (0.75 - 16) 2 x (0.75 - 16)
Flexible with ferrule		mm ²	1 x (0.75 - 35) 2 x (0.75 - 25)
Stranded		mm ²	1 x (16 - 50) 2 x (16 - 35)
Solid or stranded		AWG	single 14 - 1, double 14 - 2
Flat conductor	Lamellenzahl x Breite x Dicke	mm	2 x (6 x 9 x 0.8)
Stripping length		mm	14
Terminal screw			M6
Tightening torque		Nm	3.3
Tool			
Pozidriv screwdriver		Size	2
Standard screwdriver		mm	0.8 x 5.5 1 x 6
Terminal capacity control circuit cables			
Solid		mm ²	1 x (0.75 - 2.5) 2 x (0.75 - 2.5)
Flexible with ferrule		mm ²	1 x (0.75 - 2.5) 2 x (0.75 - 2.5)
Solid or stranded		AWG	18 - 14

Stripping length		mm	10
Terminal screw			M3.5
Tightening torque		Nm	1.2
Tool			
Pozidriv screwdriver		Size	2
Standard screwdriver		mm	0.8 x 5.5 1 x 6

Main conducting paths

Rated impulse withstand voltage	U_{imp}	V AC	8000
Overvoltage category/pollution degree			III/3
Rated insulation voltage	U_i	V AC	690
Rated operational voltage	U_e	V AC	690
Safe isolation to EN 61140			
between coil and contacts		V AC	440
between the contacts		V AC	440
Making capacity (p.f. to IEC/EN 60947)			
	Up to 690 V	A	910
Breaking capacity			
220 V 230 V		A	650
380 V 400 V		A	650
500 V		A	650
660 V 690 V		A	370
Short-circuit rating			
Short-circuit protection maximum fuse			
Type "2" coordination			
400 V	gG/gL 500 V	A	125
690 V	gG/gL 690 V	A	80
Type "1" coordination			
400 V	gG/gL 500 V	A	250
690 V	gG/gL 690 V	A	100

AC

AC-1			
Rated operational current			
Conventional free air thermal current, 3 pole, 50 - 60 Hz			
Open			
at 40 °C	$I_{th} = I_e$	A	98
at 50 °C	$I_{th} = I_e$	A	88
at 55 °C	$I_{th} = I_e$	A	83
at 60 °C	$I_{th} = I_e$	A	80
enclosed	I_{th}	A	72
Conventional free air thermal current, 1 pole			
open	I_{th}	A	200
enclosed	I_{th}	A	180
AC-3			
Rated operational current			
Open, 3-pole: 50 – 60 Hz			
Notes			At maximum permissible ambient temperature (open.) Also tested according to AC-3e.
220 V 230 V	I_e	A	65
240 V	I_e	A	65
380 V 400 V	I_e	A	65
415 V	I_e	A	65
440V	I_e	A	65
500 V	I_e	A	65
660 V 690 V	I_e	A	37

Motor rating	P	kWh	
220 V 230 V	P	kW	20
240V	P	kW	22
380 V 400 V	P	kW	30
415 V	P	kW	39
440 V	P	kW	41
500 V	P	kW	47
660 V 690 V	P	kW	35

AC-4

Open, 3-pole: 50 – 60 Hz			
220 V 230 V	I_e	A	25
240 V	I_e	A	25
380 V 400 V	I_e	A	25
415 V	I_e	A	25
440 V	I_e	A	25
500 V	I_e	A	25
660 V 690 V	I_e	A	20

Motor rating	P	kWh	
220 V 230 V	P	kW	7
240 V	P	kW	7.5
380 V 400 V	P	kW	12
415 V	P	kW	13
440 V	P	kW	14
500 V	P	kW	16
660 V 690 V	P	kW	17

DC

Rated operational current, open			
DC-1			
60 V	I_e	A	72
110 V	I_e	A	72
220 V	I_e	A	65

Current heat loss

3 pole, at I_{th} (60°)		W	25.9
Current heat loss at I_e to AC-3/400 V		W	17.1
Impedance per pole		mΩ	1.9

Magnet systems

Voltage tolerance			
AC operated	Pick-up	$x U_c$	0.8 - 1.1
Drop-out voltage AC operated	Drop-out	$x U_c$	0.3 - 0.6
Power consumption of the coil in a cold state and $1.0 \times U_S$			
50 Hz	Pick-up	VA	149
50 Hz	Sealing	VA	16
50 Hz	Sealing	W	4.1
60 Hz	Pick-up	VA	178
60 Hz	Sealing	VA	19
60 Hz	Sealing	W	4.1
Duty factor		% DF	100
Changeover time at 100 % U_S (recommended value)			
Main contacts			
AC operated			
Closing delay		ms	12 - 18
Opening delay		ms	8 - 13
Arcing time		ms	10

Electromagnetic compatibility (EMC)

Emitted interference			according to EN 60947-1
----------------------	--	--	-------------------------

Interference immunity according to EN 60947-1

Rating data for approved types

Short Circuit Current Rating		SCCR	
Basic Rating			
SCCR	kA		10
max. Fuse	A		250
max. CB	A		250
480 V High Fault			
SCCR (fuse)	kA		30/100
max. Fuse	A		250/150 Class J
SCCR (CB)	kA		65
max. CB	A		100
600 V High Fault			
SCCR (fuse)	kA		30/100
max. Fuse	A		250/150 Class J
SCCR (CB)	kA		30
max. CB	A		250
Special Purpose Ratings			
Electrical Discharge Lamps (Ballast)			
480V 60Hz 3phase, 277V 60Hz 1phase	A		88
600V 60Hz 3phase, 347V 60Hz 1phase	A		88
Incandescent Lamps (Tungsten)			
480V 60Hz 3phase, 277V 60Hz 1phase	A		88
600V 60Hz 3phase, 347V 60Hz 1phase	A		88
Resistance Air Heating			
480V 60Hz 3phase, 277V 60Hz 1phase	A		88
600V 60Hz 3phase, 347V 60Hz 1phase	A		88
Definite Purpose Ratings (100,000 cycles acc. to UL 1995)			
LRA 480V 60Hz 3phase	A		390
FLA 480V 60Hz 3phase	A		65
Elevator Control			
200V 60Hz 3phase	HP		10
200V 60Hz 3phase	A		32.2
240V 60Hz 3phase	HP		15
240V 60Hz 3phase	A		42
480V 60Hz 3phase	HP		30
480V 60Hz 3phase	A		40
600V 60Hz 3phase	HP		40
600V 60Hz 3phase	A		41

Design verification as per IEC/EN 61439

Technical data for design verification			
Rated operational current for specified heat dissipation	I_n	A	65
Heat dissipation per pole, current-dependent	P_{vid}	W	5.7
Equipment heat dissipation, current-dependent	P_{vid}	W	17.1
Static heat dissipation, non-current-dependent	P_{vs}	W	4.1
Heat dissipation capacity	P_{diss}	W	0
Operating ambient temperature min.		°C	-25
Operating ambient temperature max.		°C	60
IEC/EN 61439 design verification			
10.2 Strength of materials and parts			
10.2.2 Corrosion resistance			Meets the product standard's requirements.
10.2.3.1 Verification of thermal stability of enclosures			Meets the product standard's requirements.
10.2.3.2 Verification of resistance of insulating materials to normal heat			Meets the product standard's requirements.

10.2.3.3 Verification of resistance of insulating materials to abnormal heat and fire due to internal electric effects		Meets the product standard's requirements.
10.2.4 Resistance to ultra-violet (UV) radiation		Meets the product standard's requirements.
10.2.5 Lifting		Does not apply, since the entire switchgear needs to be evaluated.
10.2.6 Mechanical impact		Does not apply, since the entire switchgear needs to be evaluated.
10.2.7 Inscriptions		Meets the product standard's requirements.
10.3 Degree of protection of ASSEMBLIES		Does not apply, since the entire switchgear needs to be evaluated.
10.4 Clearances and creepage distances		Meets the product standard's requirements.
10.5 Protection against electric shock		Does not apply, since the entire switchgear needs to be evaluated.
10.6 Incorporation of switching devices and components		Does not apply, since the entire switchgear needs to be evaluated.
10.7 Internal electrical circuits and connections		Is the panel builder's responsibility.
10.8 Connections for external conductors		Is the panel builder's responsibility.
10.9 Insulation properties		
10.9.2 Power-frequency electric strength		Is the panel builder's responsibility.
10.9.3 Impulse withstand voltage		Is the panel builder's responsibility.
10.9.4 Testing of enclosures made of insulating material		Is the panel builder's responsibility.
10.10 Temperature rise		The panel builder is responsible for the temperature rise calculation. Eaton will provide heat dissipation data for the devices.
10.11 Short-circuit rating		Is the panel builder's responsibility. The specifications for the switchgear must be observed.
10.12 Electromagnetic compatibility		Is the panel builder's responsibility. The specifications for the switchgear must be observed.
10.13 Mechanical function		The device meets the requirements, provided the information in the instruction leaflet (IL) is observed.

Technical data ETIM 7.0

Low-voltage industrial components (EG000017) / Power contactor, AC switching (EC000066)		
Electric engineering, automation, process control engineering / Low-voltage switch technology / Contactor (LV) / Power contactor, AC switching (ecl@ss10.0.1-27-37-10-03 [AAB718015])		
Rated control supply voltage Us at AC 50HZ	V	400 - 400
Rated control supply voltage Us at AC 60HZ	V	440 - 440
Rated control supply voltage Us at DC	V	0 - 0
Voltage type for actuating		AC
Rated operation current Ie at AC-1, 400 V	A	98
Rated operation current Ie at AC-3, 400 V	A	65
Rated operation power at AC-3, 400 V	kW	30
Rated operation current Ie at AC-4, 400 V	A	25
Rated operation power at AC-4, 400 V	kW	12
Rated operation power NEMA	kW	37
Modular version		No
Number of auxiliary contacts as normally open contact		2
Number of auxiliary contacts as normally closed contact		2
Type of electrical connection of main circuit		Screw connection
Number of normally closed contacts as main contact		0
Number of main contacts as normally open contact		3

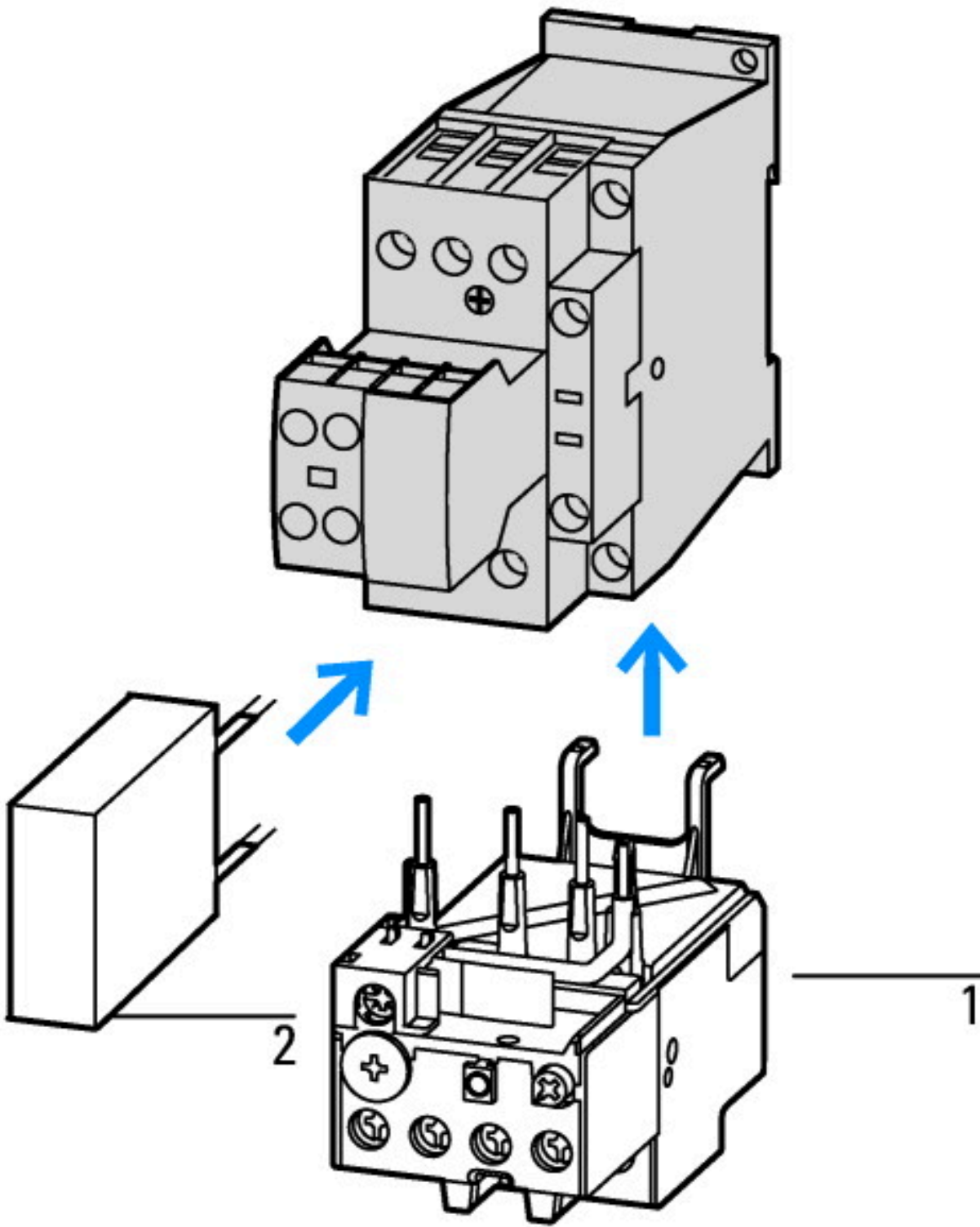

- 1: Overload relay
- 2: Suppressor

DILM1000-XHI(V)11-...

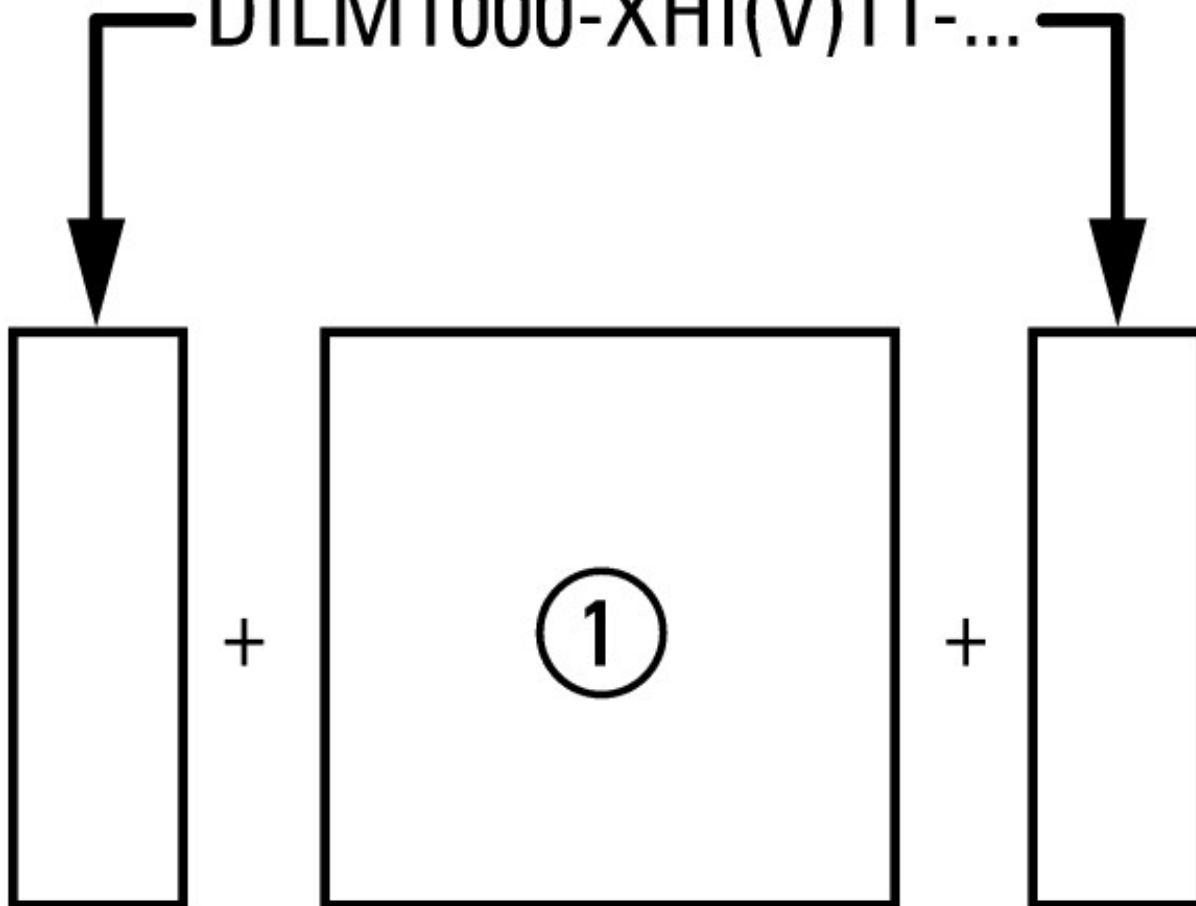

on the side: 2 x DILM1000-XHI(V)11-SI; surface mounting: 1 x DILM150-XHIA11
 on the side: 2 x DILM1000-XHI(V)11-SA; surface mounting: 1 x DILM150-XHI (2 pole)
 on the side: 1 x DILM1000-XHI(V)11-SI; surface mounting: 1 x DILM150-XHIA22
 on the side: 1 x DILM1000-XHI(V)11-SA; surface mounting: 1 x DILM150-XHI (4 pole)

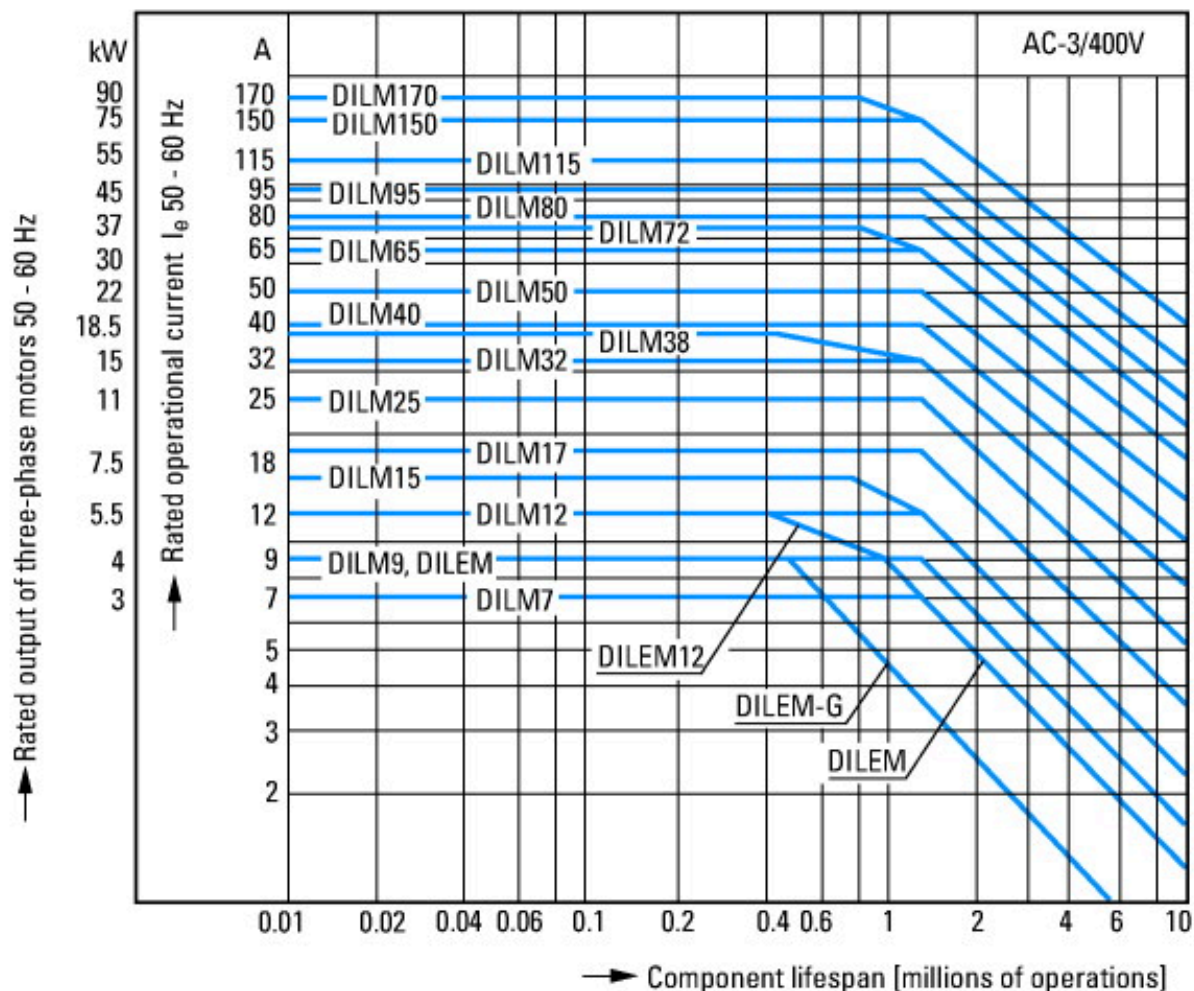

Squirrel-cage motor
 Operating characteristics
 Starting: from rest
 Stopping: after attaining full running speed
 Electrical characteristics
 Make: up to 6 x rated motor current
 Break: up to 1 x rated motor current
 Utilization category
 100 % AC-3
 Typical applications
 Compressors
 Lifts
 Mixers
 Pumps
 Escalators
 Agitators
 Fans
 Conveyor belts
 Centrifuges
 Hinged flaps
 Bucket-elevators
 Air conditioning system
 General drives in manufacturing and processing machines



Extreme switching duty
 Squirrel-cage motor
 Operating characteristics
 Inching, plugging, reversing
 Electrical characteristics
 Make: up to 6 x rated motor current
 Break: up to 6 x rated motor current
 Utilization category
 100 % AC-4
 Typical applications
 Printing presses
 Wire-drawing machines
 Centrifuges
 Special drives for manufacturing and processing machines

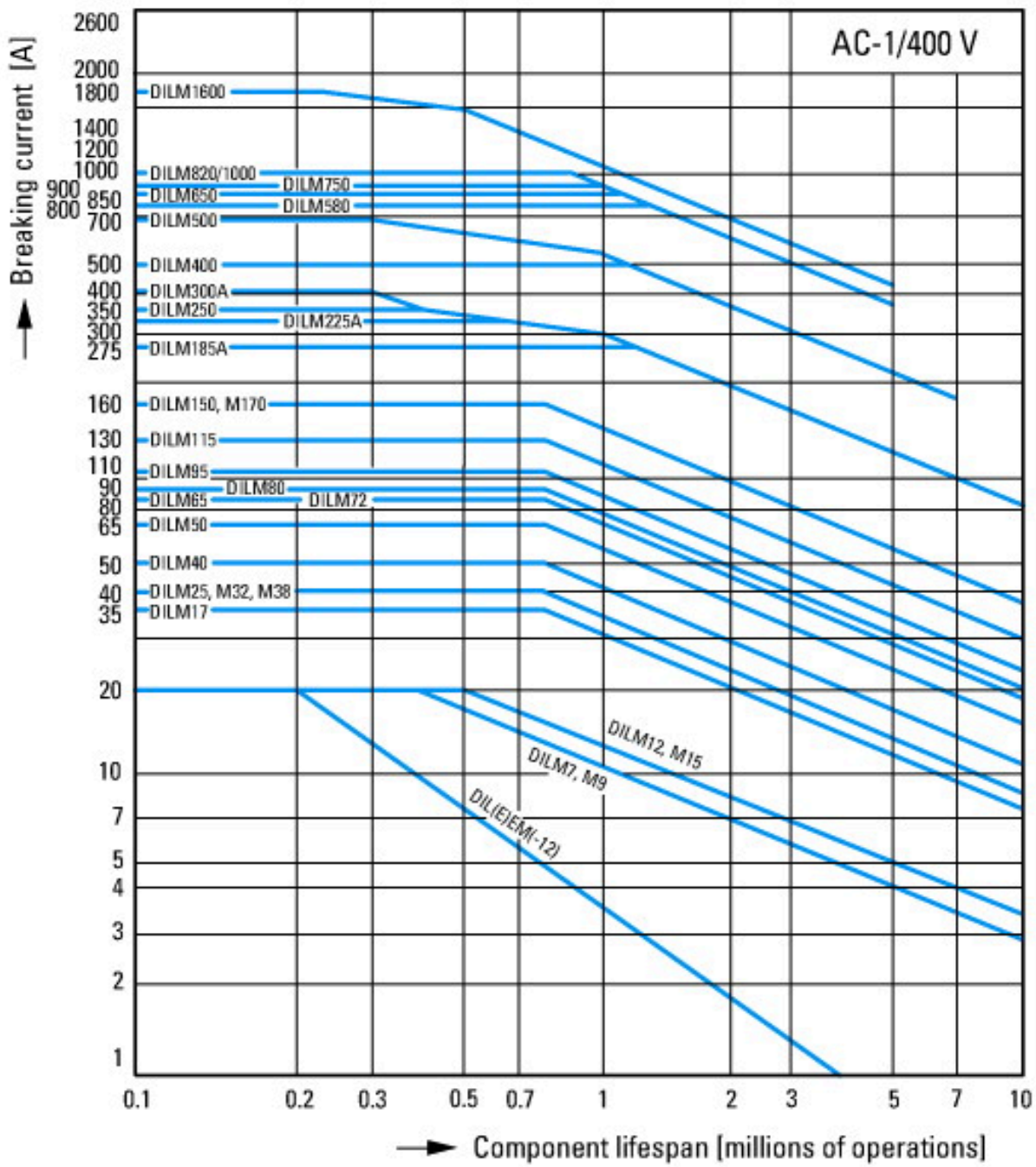

Switching conditions for 3 pole, non-motor loads
 Operating characteristics
 Non inductive and slightly inductive loads
 Electrical characteristics:
 Switch on: 1 x rated operational current
 Switch off: 1 x rated operational current
 Utilization category

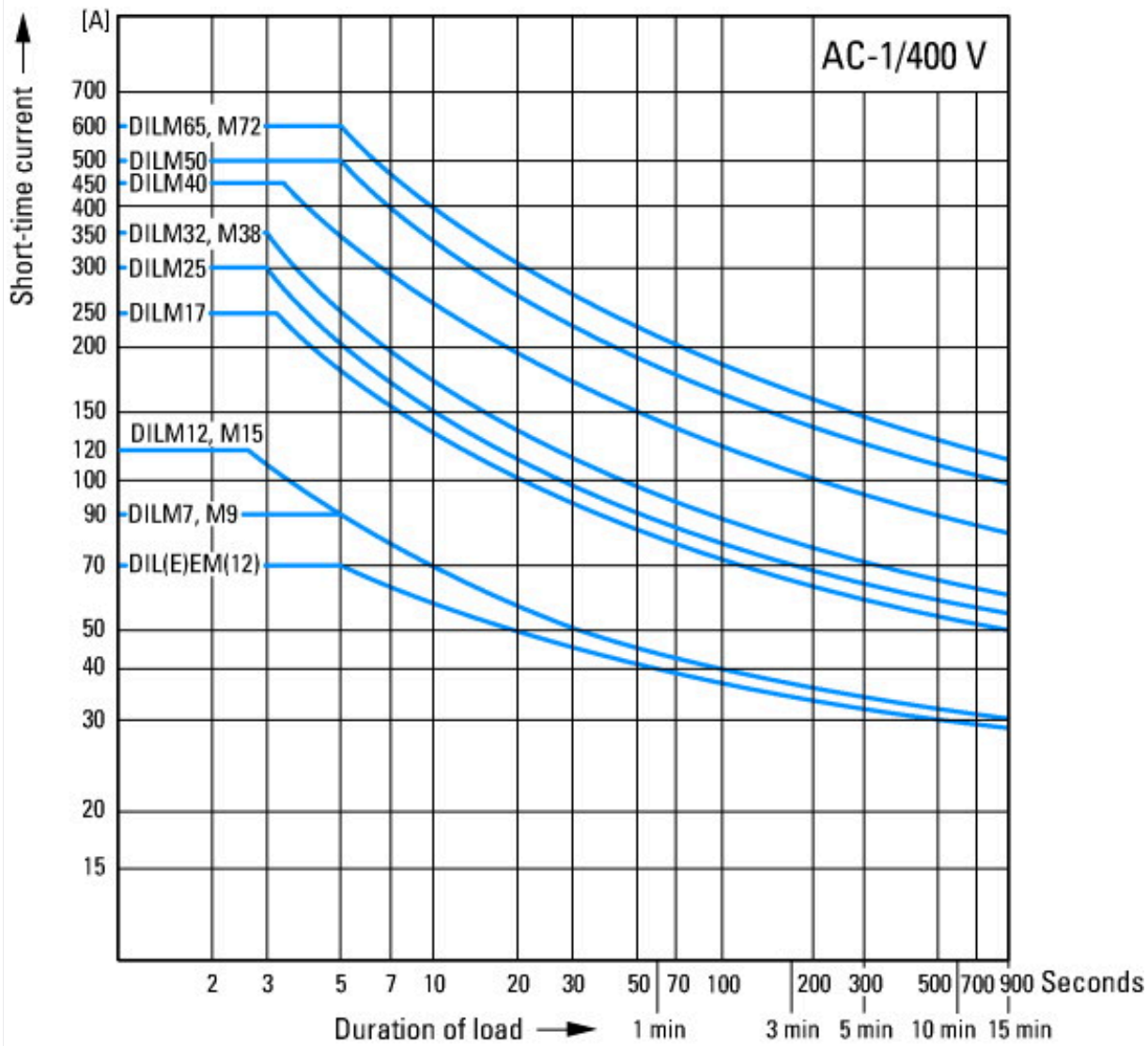

Dimensions

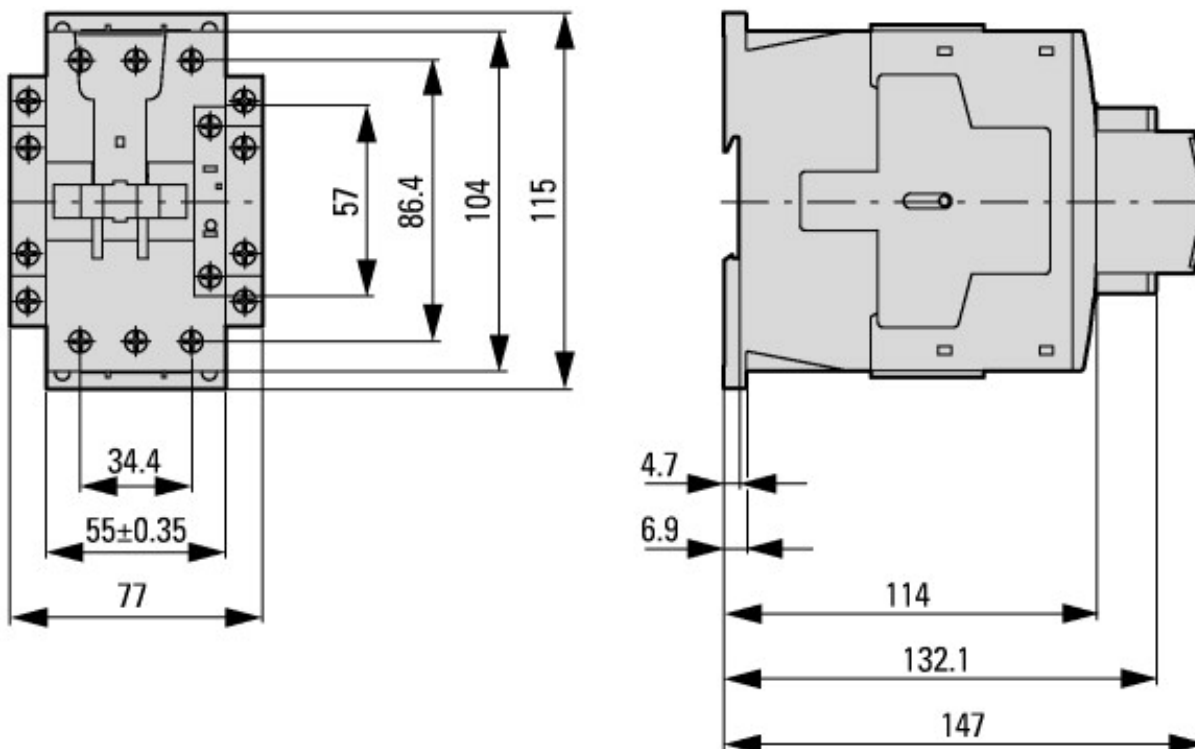

Contactor with auxiliary contact module



Lateral clearance to earthed parts: 6 mm

DILM40...DILM72
 DILMC40...DILMC65
 DILMF40...DILMF65

Additional product information (links)

Motor starters and "Special Purpose Ratings" for the North American market	http://www.eaton.eu/ecm/groups/public/@pub/@europe/@electrical/documents/content/pct_3258146.pdf
Switchgear of Power Factor Correction Systems	http://www.moeller.net/binary/ver_techpapers/ver934en.pdf
X-Start - Modern Switching Installations Efficiently Fitted and Wired Securely	http://www.moeller.net/binary/ver_techpapers/ver938en.pdf
Mirror Contacts for Highly-Reliable Information Relating to Safety-Related Control Functions	http://www.moeller.net/binary/ver_techpapers/ver944en.pdf
Effect of the Cable Capacitance of Long Control Cables on the Actuation of Contactors	http://www.moeller.net/binary/ver_techpapers/ver949en.pdf
Switchgear for Luminaires	http://www.moeller.net/binary/ver_techpapers/ver955en.pdf
Standard Compliant and Functionally Safe Engineering Design with Mechanical Auxiliary Contacts	http://www.moeller.net/binary/ver_techpapers/ver956en.pdf

The Interaction of Contactors with PLCs	http://www.moeller.net/binary/ver_techpapers/ver957en.pdf
Busbar Component Adapters for modern Industrial control panels	http://www.moeller.net/binary/ver_techpapers/ver960en.pdf