

Static Remover Ionizer · Thin type

ER-VW

CMJE-ERVW No.0053-74V

Thank you very much for using Panasonic products. Please read this Instruction Manual carefully and thoroughly for the correct and optimum use of this product. Kindly keep this manual in a convenient place for quick reference.

WARNING

- Never use this product with a device for personnel protection.
- In case of using devices for personnel protection, use products which meet laws or standards, such as OSHA, ANSI or IEC etc., for personnel protection applicable in each region or country.
- Do not use this product near or around surroundings containing any dangerous materials, such as combustible material and flammable material. Dust gathers on and around the discharge needle, and inside the nozzle depending on the environment.
- Be sure to clean up the discharge needle, periodically once a week or so, or this product will be unable to exert the charge removal performance, which may also cause ignition or product malfunction. However, when using this product in the environment exposed to too much dust, be sure to clean up the discharge needle frequently.
- Be sure to ground the main body of this product via ground terminal to ensure electric shock prevention and reliable charge removal.
- Since the discharge needle is live with high voltage, never touch the discharge needle, or an electric shock may result.
- If this product is used in an airtight room, ozone emitted from this product may be detrimental. Therefore, in order for this product to be used in an airtight room, be sure to keep the room ventilated.
- Since the ion air contains ozone, do not aim this product at anyone.
- When loosening the nozzles for aligning the blowing air or maintenance, be sure to stop applying air. Otherwise, the discharge needle may be flung out by air pressure. Furthermore, after the work, screw up the nozzles by hand till they touch the main body. Insufficient tightening may affect the charge removal capability or drop the nozzles.
- Since the tip of the discharge needle is pointed, take sufficient care in handling the discharge needle, or injuries may result.

1 OUTLINE

- This product is a corona discharge type electrostatic charge removal device.
- The nozzle angle adjustable structure enables aligning the ionized air to desired area.
- The check function which a considerable abrasion or dirt on the discharge needle is notified via the output signal and the indicator is incorporated.
- The air monitor function detects whether the air is supplied to this product or not. When the air is not supplied, a corona discharge is stopped.

2 CAUTIONS

- Make sure to use the DC power supply insulated by an isolation transformer etc. for this product. If an auto-transformer etc. (single winding transformer) is used, this product or the power supply may get damaged due to short-circuit.
- When using as a CSA and UL compliant product, use a CLASS 2 CSA/UL certified power supply, or a CSA/UL certified power supply that has been evaluated as a Limited Power Source as specified in CAN/CSA-C22.2NO.60950-1/UL60950-1.

- This product has been developed / produced for industrial use only.
- Do not use this product beyond its rated specifications. Doing so can cause product breakdown or damage. Furthermore, it may also cause a considerable reduction in product life.
- Never disassemble, repair, modify, or misuse this product, as it can cause accident or malfunction.
- Do not throw this product in fire. There is a danger of it exploding, or generating poisonous gas. Since this product emits ozone into the atmosphere, circulate the air if it is foul-smelling. If ozone stays for long period, metals etc. may oxidize / decay. Further, do not try to confirm the foul-smelling ozone by drawing your face near the nozzle outlet. There is a danger of hurting your nose, throat, etc.
- Do not use this product in steamy or dusty places and in places where water splashes or spatter flies when welding.
- Avoid use at an elevation higher than 2000m, and outdoor use.
- Make sure that the power supply is off while wiring and inspection. Otherwise, there is a danger of accident, electric shock or malfunction.
- Do not use during the initial transient time (0.5 sec.) after the power supply is switched on.
- Verify that the supply voltage variation is within the rating.
- Do not turn the power back on immediately after it has been turned off, wait at least 1 seconds before turning the power back on again.
- If power is supplied from a commercial switching regulator, ensure that the frame ground (F.G.) terminal of the power supply is connected to an actual ground.
- In case a surge is generated in the used power supply, connect a surge absorber to the supply and absorb the surge.
- Do not run the wires together with high-voltage lines or power lines or put them in the same raceway. This can cause malfunction due to induction.
- After connecting the cables, check that the connections are correct before turning on the power. If the cables are connected incorrectly, operating problems or accidents may occur.
- Use air (dried clean air) for the fluid. Fluid other than air (dried clean air) or that containing corrosive gas may cause accident or malfunction.
- Do not use air containing foreign particles, such as, carbon dust or dust, water or oil. Since those may cause electric shock or malfunction, take appropriate measures, such as, installing an air-filter or an air-drier, etc.
- Do not use this product for a purpose other than charge removal.
- Do not block the air blowing outlet. Ozone is filled in the air, causing accident or malfunction. (The air monitoring function detects by a falling of the applied air pressure. Thus, if the air blowing outlet is blocked, the discharge is not halted by detection.)
- Extension up to total 10m is possible with 0.15mm², or more, cable. However, in order to reduce noise, make the wiring as short as possible.
- When this product is no longer usable or required, carry out the appropriate disposal process meant for industrial waste.

3 MAJOR SPECIFICATIONS

Item	Type	Thin-type ionizer
	Model No.	ER-VW
Charge removal time		1 sec. or less (1,000V→100V) (Note 1)
Ion balance		±10V or less (Note 1)
Ozone generation		0.05ppm or less (Note 2)
Applicable fluid		Air (dried clean air) (Note 3)
Supplied air flow		60 L/min (ANR) or less
Air pressure range		0.05 to 0.5MPa
Power supply voltage		24V DC ± 10%
Current consumption		120mA or less
Discharge method		High frequency AC method
Discharge output voltage		2,000V approx.
Output		NPN open-collector transistor
Check output (CHECK)		· Maximum sink current: 50mA
Error output (ERROR)		· Applied voltage: 30V DC or less (between output terminal and 0V)
Discharge state output (DSC)		· Residual voltage: 1V or less (at 50mA sink current)
(Note 4)		
Output operation		Check output (CHECK): ON when a dirt or wear etc. of the discharge needle is detected, OFF when operating correctly
		Error output (ERROR): OFF when error in discharge is detected, ON during normal operation
		Discharge state output (DSC): ON during discharge operation, OFF when discharge operation is stopped
Short-circuit protection		Equipped
Discharge halt input (DSC OFF) (Note 4)		Discharge halt: short-circuit with 0V Discharge allowed (operation start): Open
Reset input (RESET)		In the state that operation is stopped due to an error detection, open 0V of the power supply from short-circuit state to cancel ERROR.
Indicators	Power (POWER)	Green LED (Lights up when the power is ON)
	Discharge (DSC) (Note 4)	Green LED (Lights up when discharging)
	Air monitor (AIR) (Note 5)	Orange LED (Lights up when air is not supplied)
	Check (CHECK)	Orange LED (Lights up when a dirt or wear etc. of the discharge needle is detected)
	Error (ERROR)	Red LED (Lights up when error in discharge is detected)
Pollution level		2
Over-voltage category		1
Ambient temperature		0 to +55°C (No dew condensation), Storage: -10 to +65°C
Ambient humidity		35 to 65% RH, Storage: 35 to 65% RH
Operating altitude		2,000m or less (Note 6)
I/O connector		For power supply / I/O: 8-way connector, For connection: 9-way connector
No. of series connection		Maximum connectable number: 5 units (including this unit)
Enclosure earthing method		C (capacitor) earth
Material		Enclosure: ABS (Nickel plated), Nozzle mounting part: Stainless steel, Screw mounting part: Stainless steel, Nozzle: Stainless steel, Discharge needle: Tungsten
Weight		110g approx.
Accessories		Connection cable: 1 pc. (cable length 0.5m) End connector (9-way): 1 pc., Lead wire for F.G. connection: 1 pc.

- Notes: 1) A typical sample (measured on a sample left in the atmosphere at a relative humidity of 65% RH for 24 hours) applied with a supply voltage of 24V, a distance of 100mm from the front surface of the airflow inlet and a pressure of 0.25MPa.
- 2) A typical sample applied with a supply voltage of 24V, a distance of 300mm from the front surface of the air flow inlet and a pressure of 0.25MPa.
- 3) The dried clean air is dried (dew point: equivalent of -20°C) and filtered (mesh-size: equivalent of 0.01 μm) air.
- 4) 'DSC' stands for 'DISCHARGE'.
- 5) Discharge is stopped when the indicator lights up.
- 6) Do not use or store the device in an environment where the air pressure is higher than the atmospheric pressure at an altitude of 0 meters.

● **Optional**

- AC adapter

Model No.	Description
ER-VAPS-W	IN: 100 to 120V AC, 50/60Hz, 40VA OUT: 24V DC, 750mA (Accessory: Conversion connector)

- Connection cable

Model No.	Description
ER-VWCC2	Cable length 2m
ER-VWCC5	Cable length 5m
ER-VWCC9	Cable length 9m

- Discharge needle set (2 pcs./set)

Model No.	Description
ER-VWANT	Unit with a tungsten needle

- Series connection set

Model No.	Description
ER-VWAR80	Series connection cable (Cable length 0.8m), Air inlet fitting

4 MOUNTING

- When this product is mounted on to a surface, use M4 pan-head screw (please arrange separately). The tightening torque should be 0.5N·m or less.
- Be sure to ground the F.G. terminal. If the grounding is not proper, the charge removal capability deteriorates considerably. (Direct earth or power supply common earth)
- The power supply common earth can also be connected with the accessory lead wire for F.G. connection. 0V earth: Connect No. 2 and No. 3 of the end connector (9-way) with the lead wire for F.G. connection. +V earth: Connect No. 1 and No. 3 of the end connector (9-way) with the lead wire for F.G. connection. (Wrong wiring of the grounding causes accident or malfunction. Check the grounding condition) to be used beforehand and take care not to short-circuit the power supply when wiring.
- If AC adapter is used, be sure to connect the F.G. terminal to the power supply common earth. For details of wiring, refer to the instruction manual enclosed with the AC adapter for ER-VW series (ER-VAPS1-W).

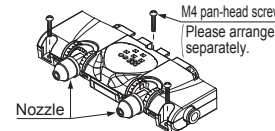

5 ALIGNMENT OF BLOWING AIR

- ① Screwing the nozzle down.
 - ② Aim the nozzle to the object being charged.
 - ③ After aligning, tighten the nozzle by hand till it touches the main body and confirm that the nozzle doesn't move.
- If the nozzle is not tightened enough, the charge removal capability may deteriorate or the nozzle may drop.
 - The adjustable range of the nozzle is shown in the right figure.

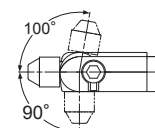

6 PIPING

- The air tube to be attached to the air inlet of this product should be the outer diameter φ6mm / internal diameter φ4mm.
- Supply dried clean air to this product. (Air dryer: dew point -20°C equivalent, Air filter: mesh size 0.01 μm equivalent)
- Since air pressure drops depending on the length of the air tube from the air supply source or adding the pneumatic equipments (needle valve, speed-controller or mini-filter etc.), take care that the air pressure of the supplied air to the product is maintained. (The applied pressure should be checked around the air inlet of each unit.) Furthermore, choose the appropriate pneumatic equipments in terms of air flow.

7 CONNECTION

Take care that when using the products in series connection, the applied air pressure drops gradually unit by unit. (The volume of the drop depends on the connected tube length.)

- Use the optional series connection set (ER-VWAR80) for series connection (One set per unit is required). The maximum No. of the connectable units is 5 (Including this unit). When using the units in series connection, fit the end connector on the connector for series connection of the unit connected to the end. Even if only one unit is used, fit the end connector on the connector for series connection.
- Fit the air inlet fitting (enclosed with the series connection set) after taking the sealing cap off with a hexagonal wrench. The tightening torque should be 0.5N·m or less. Note that the gasket is fit in the air inlet. Be sure to tighten the fitting with the gasket.
- When using the units in series connection, make sure that the air pressure around the air inlet of each unit is appropriate.

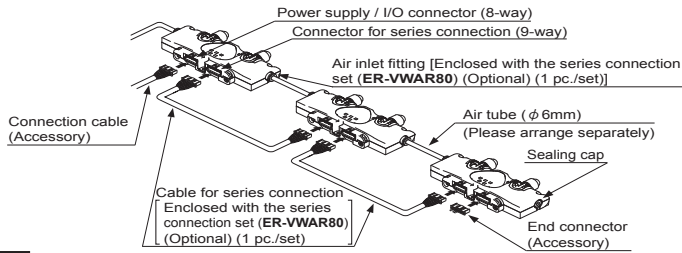

8 I/O DIAGRAM

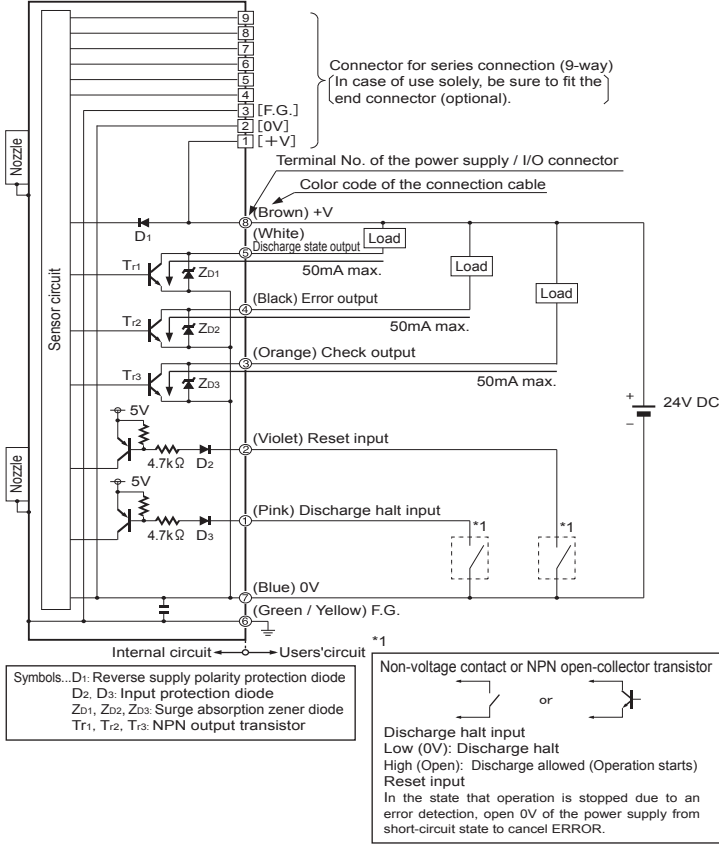

● Connector pin arrangement

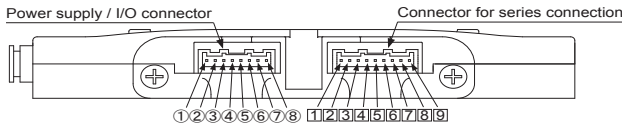

9 INPUT SIGNAL CONDITIONS

- Conditions for the discharge halt input and the reset input are as follows.

Discharge halt input

Reset input

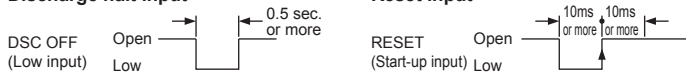

Note: Repeat control with 'DSC OFF' input should be 1Hz or less.

Note that the continuous discharge for 2 sec. or more is required for stable detection of check output. (CHECK). In case of using with the continuous discharge for less than 2 sec. again and again, confirm the check output (CHECK) with the continuous discharge for 2 sec. or more when maintenance is carried out.

10 OPERATION MATRIX

	Indicators (☀ : Light up, ● : OFF)					Output			Discharge through needle (Corona discharge)
	Power (POWER)	Discharge (DSC)	Air monitor (AIR) (Note 1)	Check (CHECK)	Error (ERROR)	Discharge state	Check	Error	
Normal (with air)	☀	☀	●	●	●	ON	OFF	ON	ON
Normal (without air)	☀	●	☀	●	●	OFF	OFF	ON	OFF
Operation state	☀	●	●	☀	●	ON	ON	ON	ON
Check	☀	●	●	☀	●	OFF	OFF	OFF	OFF
Error	☀	●	●	●	☀	OFF	OFF	OFF	OFF
Discharge halt input	☀	●	●	●	●	OFF	OFF	ON	OFF
Reset input	☀	(Maintained)	(Maintained)	(Maintained)	●	(Maintained)	(Maintained)	ON	(Allowed)

- Notes: 1) The air monitor function is to monitor the supplied air pressure. If the air pressure falls less than 0.02MPa approx., the discharge from the needle stops and the indicator lights up. If the air pressure rises again after the pressure fall was detected, discharge starts again.
- 2) The air monitor function always check the air pressure and independent from the other functions (ERROR, CHECK or the discharge halt input). Thus, even in the state that the discharge was stopped by another function, if the air pressure falls, the air monitor indicator (orange) lights up.
- 3) In the state that the discharge from the needle stops, such as when the air pressure fall is detected or while the discharge halt input is input etc., CHECK and ERROR detection function do not operate.
- 4) The discharge halt input is invalid in error state. CHECK function doesn't operate as well.
- 5) When the discharge from the needle stops due to the air monitor function, the discharge halt input or ERROR detection function, the detection result by CHECK function is erased. The detection is carried out again when the discharge from the needle restarts.
- 6) Remove the cause of error, and then reset the unit. In case the cause of error has not been removed, the unit goes into the error state again.
- 7) In order to reset the unit in error state, turn the power off and on again.
- 8) In case the discharge from the needle is controlled in the state that air is supplied, CHECK may be output temporarily due to a transitional state of the discharge phenomenon. However, the charge removal capability remains the same.

11 MAINTENANCE

⚠ WARNING

- Make sure to turn off the applying air and the power supply while inspection, cleaning or maintenance is carried out.
- Before loosening the nozzles for maintenance etc., be sure to stop applying air. Otherwise, the discharge needle unit may be flew by the air pressure.
- If dirt, such as dust, etc., is stuck on and around the discharge needle or inside the nozzle depending on the environment of use, the charge removal effect deteriorates. Clean those areas periodically, as a reference, once a week. However, when using this product in the environment exposed to too much dust, be sure to clean up the discharge needle frequently.
- The discharge needle is a part having a product life time. It is recommended that the needle should be replaced, as a reference, after 10,000 hours in use. When the needle is replaced, replace the discharge needle unit (optional).

Procedure for cleaning and replacing the discharge needle nit

- ① Unscrew the discharge needle counterclockwise.
- ② Remove dirt on and around the discharge needle, inside the nozzle and inside the tube fit in the nozzle with a cotton bud soaked in absolute alcohol. Particularly, clean inside the tube fit inside the nozzle and around the discharge needle thoroughly such that any dirt or grease doesn't remain there (refer to the right figure), or the charge removal capability may deteriorate. Remove / fit the discharge needle along the guide groove on the air outlet of the main body.
- ③ After cleaning, screw the nozzle clockwise. Tighten the nozzle by hand till it stops and then confirm that the nozzle doesn't move. If the nozzle is not tightened enough, the charge removal capability may deteriorate or the nozzle may come off.

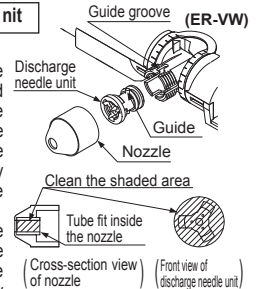

12 TROUBLE SHOOTING

⚠ WARNING

- Always be sure to turn off the power before checking the discharge part.

problem	Cause	Remedy
Air monitor ("AIR") indicator (orange) lights up	Air is not supplied Air pressure drops	<ul style="list-style-type: none"> ● Make sure that the supply voltage is within the specifications. ● Make sure that the air pressure is not lower than the specified value (0.05MPa) around this product. ● Make sure that the air tube is inserted to the air inlet fitting firmly.
Check ("CHECK") indicator (orange)	Nozzle is loose Discharge needle is dirty Discharge needle is worn F.G. is not connected Condensation	<ul style="list-style-type: none"> ● Make sure that the supply voltage is within the specifications. ● Check the tip of the discharge needle for chip and contamination, and make sure that the discharge needle unit is mounted properly on the main body. ● If the CHECK indicator (orange) lights up even after cleaning the discharge needle, also check the nozzle part for contamination. ● Make sure that the nozzle is mounted properly. ● Make sure that the applied air pressure is within the specifications. Check whether the F.G. terminal is connected.
Error ("ERROR") indicator (red)	Condensation Foreign part F.G. is not connected Nozzle is loose	<ul style="list-style-type: none"> ● Make sure that the supply voltage is within the specifications. ● Abnormal discharge is possible. Turn off the power supply, check the tip of the discharge needle for chip and contamination, and make sure that the discharge needle unit is mounted properly on the main body. Also, check the inside of the nozzle for foreign objects, and make sure that the nozzle is mounted and installed properly.
Doesn't go back to normal state by reset	Cause is not removed	<ul style="list-style-type: none"> ● Check that the cause of 'CHECK' or 'ERROR' is removed.

13 INTENDED PRODUCTS FOR CE MARKING

- The models listed under "3 SPECIFICATIONS" come with CE Marking. As for all other models, please contact our office.

● Contact for CE

Panasonic Marketing Europe GmbH Panasonic Testing Center
Winsbergring 15, 22525 Hamburg, Germany

14 CSA/UL compliant product

- This product complies with CSA and UL standards, and has been certified by TUV SUD.

Panasonic Industrial Devices SUNX Co., Ltd.

<http://panasonic.net/id/pidsx/global>

Overseas Sales Division (Head Office)

2431-1 Ushiyama-cho, Kasugai-shi, Aichi, 486-0901, Japan
Phone: +81-568-33-7861 FAX: +81-568-33-8591

About our sale network, please visit our website.

PRINTED IN JAPAN

© Panasonic Industrial Devices SUNX Co., Ltd. 2016