

Panasonic[®]

TEMPERATURE CONTROLLER KT9 INSTRUCTION MANUAL

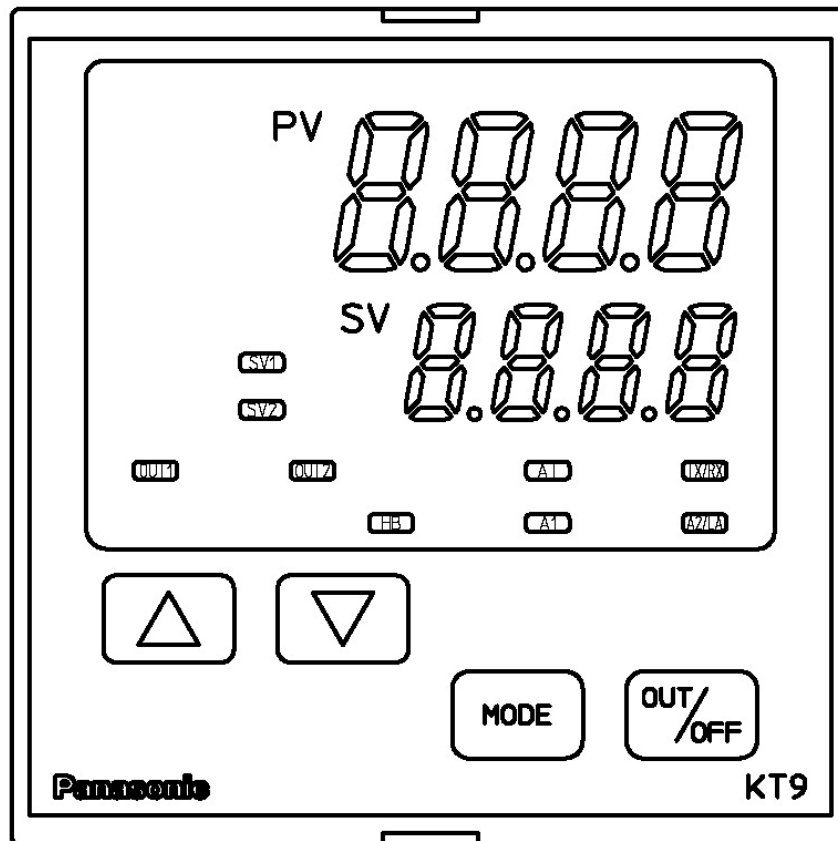

Preface

Thank you for the purchase of **Panasonic**[®] Temperature controller KT9.

This manual contains instructions for the mounting, functions, operations and notes when operating the KT9.

For model confirmation and unit specifications, please read this manual carefully before starting operation.

To prevent accidents arising from the misuse of this controller, please ensure the operator receives this manual.

Notes

- This instrument should be used according to the specifications described in the manual. If it is not used according to the specifications, it may malfunction or cause fire.
- Be sure to follow the warnings, cautions and notices. If they are not observed, it could cause serious injury or accidents.
- The contents of this instruction manual are subject to change without notice.
- Care has been taken to assure that the contents of this instruction manual are correct, but if there are any doubts, mistakes or questions, please inform our sales department.
- This instrument is designed to be installed in a control panel. If it is not, measures must be taken to ensure that the operator cannot touch power terminals or other high voltage sections.
- Any unauthorized transfer or copying of this document, in part or in whole, is prohibited.
- Panasonic Industrial Devices SUNX Co., Ltd. is not responsible for any damage or secondary damage(s) incurred as a result of using this product, including any indirect damage.
- To pull out the inner assembly, release the hooks at the top and bottom of the instrument with thin, hard tweezers. (If the hooks are released too far, they may be broken, or IP66 function could deteriorate. Do not pull out the inner assembly except when repairing the instrument.)

SAFETY PRECAUTIONS

(Be sure to read these precautions before using our products.)

The safety precautions are classified into categories: "Warning" and "Caution".

Depending on circumstances, procedures indicated by  Caution may be linked to serious results, so be sure to follow the directions for usage.

Warning

Procedures which may lead to dangerous conditions and cause death or serious injury, if not carried out properly.

Caution

Procedures which may lead to dangerous conditions and cause superficial to medium injury or physical damage or may degrade or damage the product, if not carried out properly.

1. Installation precautions

Caution

This instrument is intended to be used under the following environmental conditions (IEC61010-1): Overvoltage category II, Pollution degree 2

Ensure the mounting location corresponds to the following conditions:

- A minimum of dust, and an absence of corrosive gases
- No flammable, explosive gases
- No mechanical vibrations or shocks
- No exposure to direct sunlight, an ambient temperature of 0 to 50°C (32 to 122°F) that does not change rapidly
- An ambient non-condensing humidity of 35 to 85%RH
- No large capacity electromagnetic switches or cables through which large current is flowing
- No water, oil or chemicals or where the vapors of these substances can come into direct contact with the unit

Note: Do not install this instrument near flammable material even though the case of this instrument is made of flame-resistant resin.

Avoid setting this instrument directly on flammable material.

2. Wiring precautions

Caution

- Use the solderless terminal with an insulation sleeve that fits in the M3 screw when wiring the KT9 Series.
- The terminal block of this instrument is designed to be wired from the left side. The lead wire must be inserted from the left side of the terminal, and fastened with the terminal screw.
- Tighten the terminal screw within the specified torque.
If excessive force is applied to the screw when tightening, the terminal screw or case may be damaged.
- Do not apply a commercial power source to the sensor which is connected to the input terminal nor allow the power source to come into contact with the sensor.
- This controller does not have built-in power switch, circuit breaker or fuse.
It is necessary to install them near the controller.
(Recommended fuse: Time-lag fuse, rated voltage 250V AC, rated current 2A)
- For a 24V AC/DC power source, do not confuse polarity when using direct current (DC).

3. Running and maintenance precautions

Warning

- It is recommended that the PID auto-tuning be performed on the trial run.
- Do not touch live terminals. This may cause electric shock or problems in operation.
- Turn the power supply to the instrument OFF before retightening the terminal and cleaning.
Working on or touching the terminal with the power switched ON may result in severe injury or death due to Electric Shock.
- Use a soft, dry cloth when cleaning the instrument.
(Alcohol based substances may tarnish or deface the unit)
- As the display section is vulnerable, do not strike or scratch it with a hard object.

--- CONTENTS ---

1. Model number	
1.1 Explanation of model number -----	6
1.2 Rated input -----	7
1.3 How to read the rated label -----	7
2. Name and functions of the sections -----	8
3. Mounting to the control panel	
3.1 Site selection -----	10
3.2 External dimensions (Unit: mm) -----	10
3.3 Panel cutout (Unit: mm) -----	10
3.4 CT (current transformer) external dimensions (Unit: mm) -----	11
3.5 Mounting -----	11
4. Wiring	
4.1 Terminal arrangement -----	12
4.2 Wiring examples -----	13
5. Setup	
5.1 Operation flowchart -----	16
5.2 Main setting mode	
SV1 -----	18
SV2 -----	18
5.3 Output MV indication -----	18
5.4 Sub setting mode	
AT/Auto-reset -----	18
OUT1 proportional band -----	19
OUT2 proportional band -----	19
Integral time -----	19
Derivative time -----	19
ARW (Anti-reset windup) -----	19
OUT1 proportional cycle -----	19
OUT2 proportional cycle -----	19
A1 value -----	20
A2 value -----	20
HB (Heater burnout alarm) value -----	20
5.5 Auxiliary function setting mode 1	
Set value lock -----	21
SV high limit -----	21
SV low limit -----	21
Sensor correction -----	21
Communication protocol -----	21
Instrument number -----	21
Communication speed -----	21
Parity -----	22
Stop bit -----	22
5.6 Auxiliary function setting mode 2	
Input type -----	22
Scaling high limit -----	23
Scaling low limit -----	23
Decimal point place -----	23
PV filter time constant -----	23

--- CONTENTS ---

OUT1 high limit -----	23
OUT1 low limit -----	23
OUT1 ON/OFF action hysteresis -----	23
OUT2 action mode -----	23
OUT2 high limit -----	24
OUT2 low limit -----	24
Overlap band/Dead band -----	24
OUT2 ON/OFF action hysteresis -----	24
A1 type -----	24
A2 type -----	25
A1 action Energized/Deenergized -----	25
A2 action Energized/Deenergized -----	25
A1 hysteresis -----	25
A2 hysteresis -----	25
A1 action delayed timer -----	25
A2 action delayed timer -----	25
Direct/Reverse action -----	26
AT bias -----	26
Setting item not used -----	26
SV2 indication -----	26
Output status selection when input abnormal -----	26
OUT/OFF key function -----	26
5.7 Control output OFF function -----	27
5.8 Auto/Manual control -----	27
6. Running -----	28
7. Action explanation	
7.1 OUT1 action -----	29
7.2 Heater burnout alarm action (option) -----	29
7.3 OUT1 ON/OFF action -----	30
7.4 OUT2 (Heating/Cooling control) action (option) -----	31
7.5 OUT2 (Heating/Cooling control) action (when setting Dead band) ---	32
7.6 OUT2 (Heating/Cooling control) action (when setting Overlap band) -	33
7.7 A1, A2 action -----	34
7.8 SV1/SV2 external selection -----	35
8. Control action explanations	
8.1 PID -----	35
8.2 PID auto-tuning of this controller -----	35
8.3 Auto-reset (offset correction) -----	36
9. Specifications	
9.1 Standard specifications -----	37
9.2 Optional specifications -----	42
10. Troubleshooting	
10.1 Indication -----	44
10.2 Key operation -----	45
10.3 Control -----	46
11. Character table -----	46

1. Model number

1.1 Explanation of model number

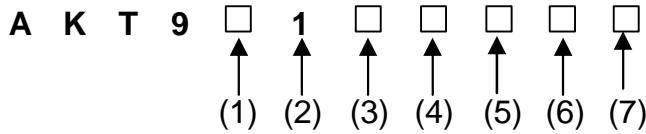

- (1) Supply voltage ----- 1: 100 to 240V AC 2: 24V AC/DC
- (2) Input type ----- 1: Multi-input (Thermocouple, RTD, DC current and DC voltage can be selected by keypad operation.
For DC current input, 50Ω shunt resistor (AKT4810, sold separately) must be connected between input terminals.)
- (3) Control output (OUT1) ----- 1: Relay contact 2: Non-contact voltage (Voltage output for SSR drive) 3: DC current
- (4) Alarm output ----- 1: A1 output 2: A1 output + A2 output
(The alarm type and Energized /Deenergized can be selected by keypad operation)
- (5) Heating/Cooling control (OUT2) output:
0: Not available 1: Relay contact
2: Non-contact voltage 3: DC current
- (6) Heater burnout alarm ----- 0: Not available 1: Available (5A) 2: Available (10A) 3: Available (20A) 4: Available (50A)
(Heater burnout alarm is not available for the DC current output)
- (7) Serial communication ----- 1: Applied (The number is added only when Serial communication is applied.)

1.2 Rated input

Input type	Input range		Resolution
K	-200 to 1370 °C	-320 to 2500 °F	1°C(°F)
	-199.9 to 400.0 °C	-199.9 to 750.0 °F	0.1°C(°F)
J	-200 to 1000 °C	-320 to 1800 °F	1°C(°F)
R	0 to 1760 °C	0 to 3200 °F	1°C(°F)
S	0 to 1760 °C	0 to 3200 °F	1°C(°F)
B	0 to 1820 °C	0 to 3300 °F	1°C(°F)
E	-200 to 800 °C	-320 to 1500 °F	1°C(°F)
T	-199.9 to 400.0 °C	-199.9 to 750.0 °F	0.1°C(°F)
N	-200 to 1300 °C	-320 to 2300 °F	1°C(°F)
PL-II	0 to 1390 °C	0 to 2500 °F	1°C(°F)
C(W/Re5-26)	0 to 2315 °C	0 to 4200 °F	1°C(°F)
Pt100	-199.9 to 850.0 °C	-199.9 to 999.9 °F	0.1°C(°F)
	-200 to 850 °C	-300 to 1500 °F	1°C(°F)
JPt100	-199.9 to 500.0 °C	-199.9 to 900.0 °F	0.1°C(°F)
	-200 to 500 °C	-300 to 900 °F	1°C(°F)
4 to 20mA DC	-1999 to 9999 *1, *2		1
0 to 20mA DC	-1999 to 9999 *1, *2		1
0 to 1V DC	-1999 to 9999 *1		1
0 to 10V DC	-1999 to 9999 *1		1
1 to 5V DC	-1999 to 9999 *1		1
0 to 5V DC	-1999 to 9999 *1		1

*1: For DC input, the input range and decimal point place can be changed.

*2: For DC current input, 50Ω shunt resistor (AKT4810, sold separately) must be connected between input terminals.

1.3 How to read the rated label

The rated label is attached to the case.

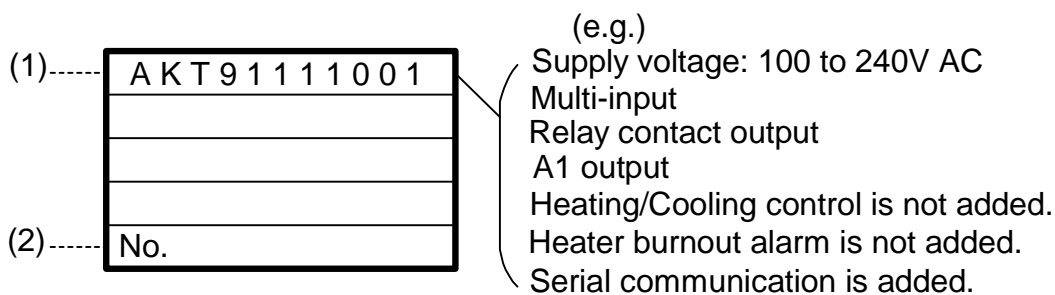

(1) Model number, supply voltage, input type, output type, etc. are entered.

(2) Lot number is entered.

2. Name and functions of the sections

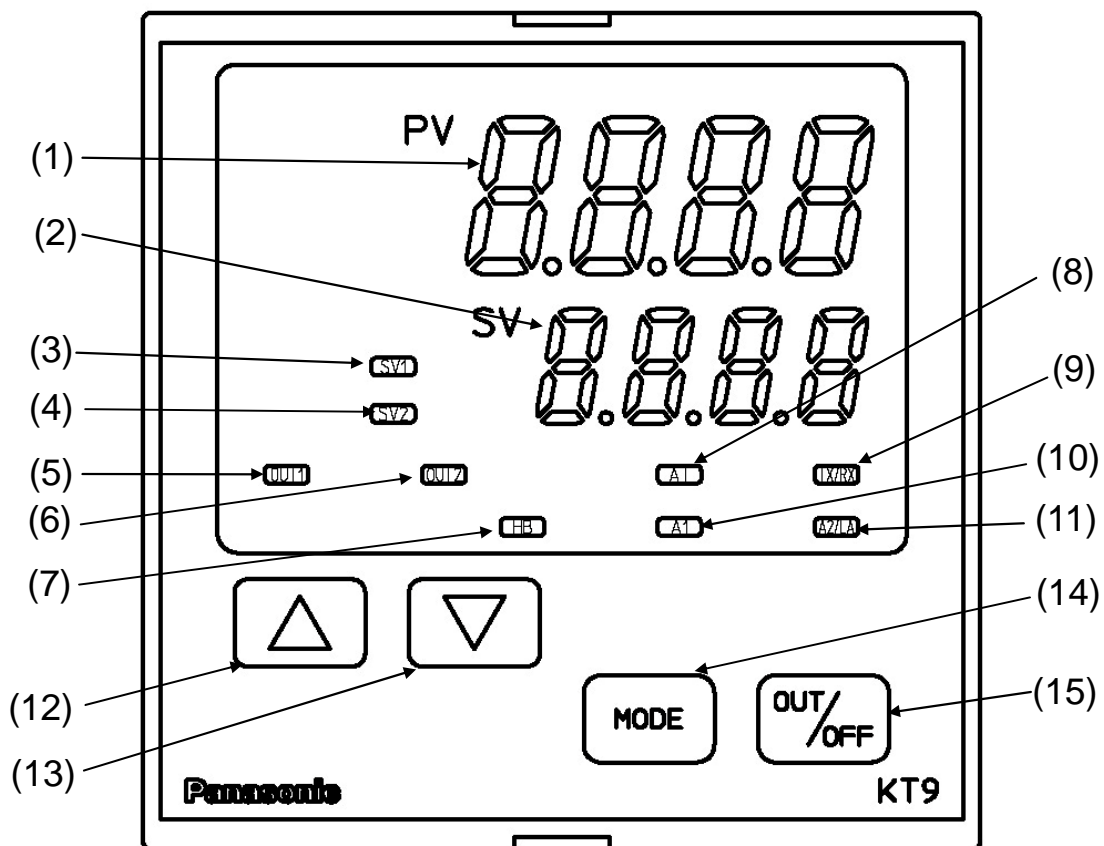

(Fig. 2-1)

- (1) PV display
Indicates the PV (process variable) with a red LED.
- (2) SV display
Indicates the SV (main set value) or MV (manipulated variable) with a green LED.
- (3) SV1 indicator
The green LED lights when SV1 is selected.
- (4) SV2 indicator
The yellow LED lights when SV2 is selected.
- (5) OUT1 indicator
When OUT1 or Heating output is on, the green LED lights.
(For the DC current output type, this flashes corresponding to the output manipulated variable in 0.25 second cycles)
- (6) OUT2 indicator
When OUT2 is on, the yellow LED lights.
(For the DC current output type, this flashes corresponding to the output manipulated variable in 0.25 second cycles)
- (7) HB indicator
When Heater burnout alarm output or sensor burnout alarm output is on, the red LED lights.
(When Heater burnout alarm is added and if indication is overscale or underscale, the red LED lights as well)
- (8) AL1 indicator
- (9) AL2 indicator
- (10) AL3 indicator
- (11) AL4 indicator
- (12) Up arrow button
- (13) Down arrow button
- (14) MODE button
- (15) OUT/OFF button

(8) AT indicator

The yellow LED flashes during auto-tuning or auto-reset.

(9) TX/RX indicator

The yellow LED flashes during Serial communication.

(10) A1 indicator

When A1 output is on, the red LED lights.

(11) A2/LA indicator

When A2 output is on, the red LED lights.

(12) Increase key: Increases the numeric value.

(13) Decrease key: Decreases the numeric value.

(14) Mode key: Selects the setting mode or registers the set value.

(By pressing the Mode key, the set value or selected value can be registered.)

(15) OUT/OFF key

- If OUT/OFF function is selected during OUT/OFF function selection, the control output is turned on or off.

Once the control output OFF function is enabled, the function cannot be released even if the power to the instrument is turned OFF and turned ON again.

To cancel the function, press the OUT/OFF key again for approx. 1 second.

- If Auto/Manual control function is selected from OUT/OFF function selection, automatic control is performed when the power to the controller is turned on. In this status, if the OUT/OFF key is pressed, the automatic control output is switched to manual control output and vice versa. However, this function can be switched only in the PV/SV display mode.



Notice

When setting the specifications and functions of this controller, connect terminals 2 and 3 for power source first, then set them referring to “5. Setup” before performing “3. Mounting to the control panel” and “4. Wiring”.

3. Mounting to the control panel

3.1 Site selection

This instrument is intended to be used under the following environmental conditions (IEC61010-1): **Overvoltage category II, Pollution degree 2**

Ensure the mounting location corresponds to the following conditions:

- (1) A minimum of dust, and an absence of corrosive gases
- (2) No flammable, explosive gases
- (3) No mechanical vibrations or shocks
- (4) No exposure to direct sunlight, an ambient temperature of 0 to 50°C (32 to 122°F) that does not change rapidly
- (5) An ambient non-condensing humidity of 35 to 85%RH
- (6) No large capacity electromagnetic switches or cables through which large current is flowing
- (7) No water, oil or chemicals or where the vapors of these substances can come into direct contact with the unit

3.2 External dimensions (Unit: mm)

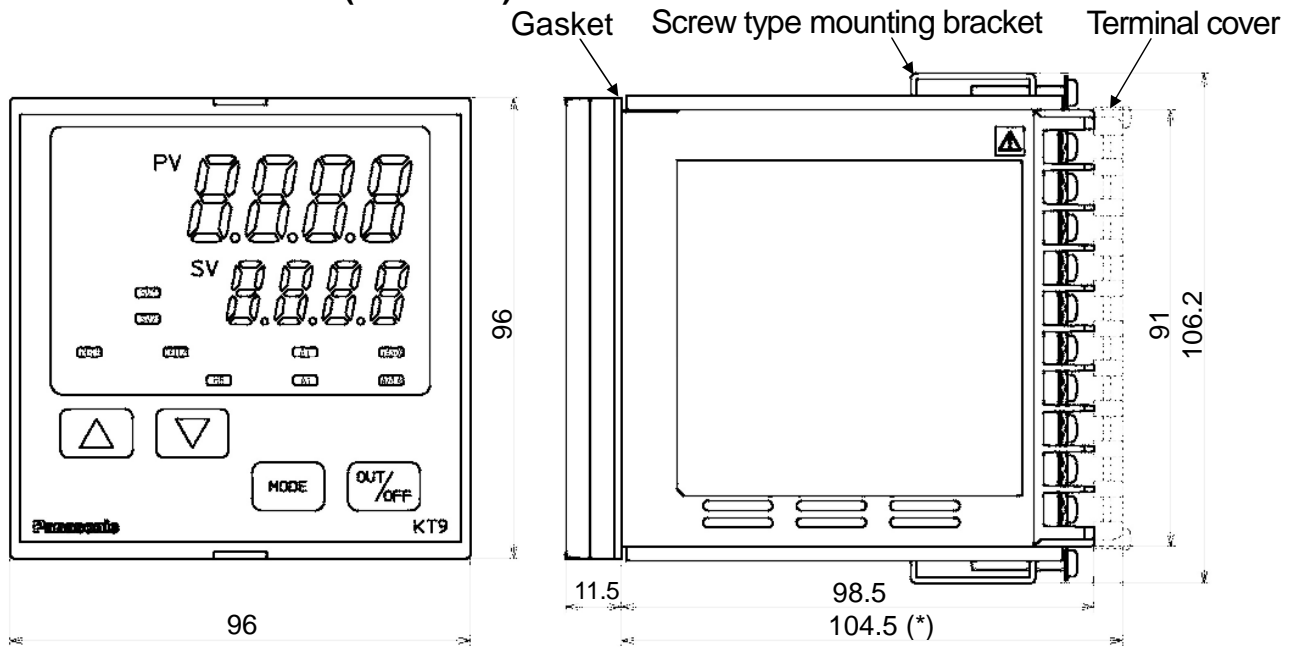

(Fig. 3.2-1)

(*): When terminal cover is used

3.3 Panel cutout (Unit: mm)

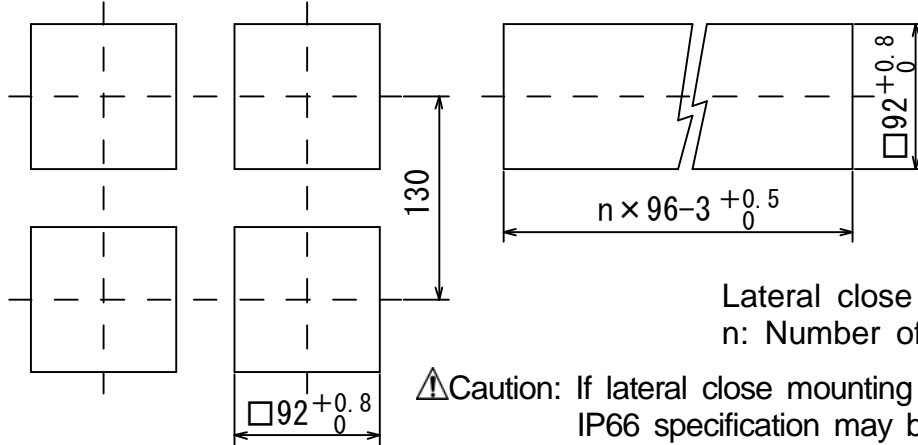

(Fig. 3.3-1)

Lateral close mounting
n: Number of units mounted

⚠ Caution: If lateral close mounting is used for the controller, IP66 specification may be compromised, and all warranties will be invalidated.

3.4 CT (Current transformer) external dimensions (Unit: mm)

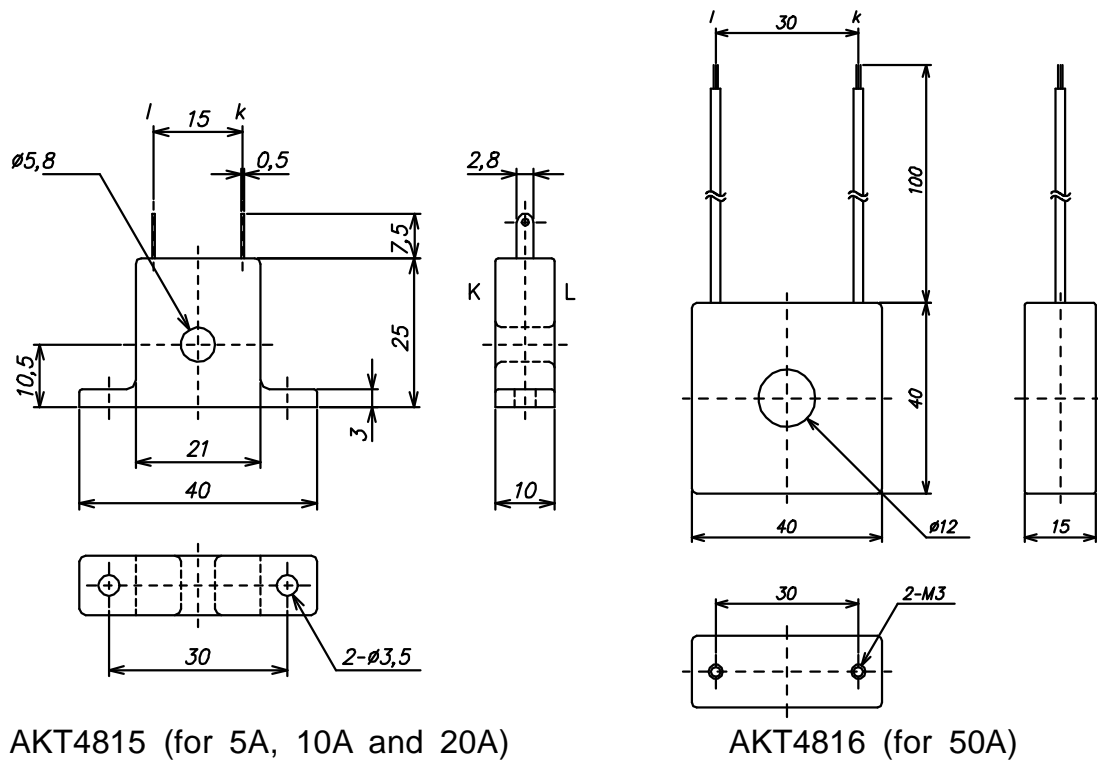

(Fig. 3.4-1)

3.5 Mounting

Notice

As the case is made of resin, do not use excessive force while screwing in the mounting bracket, or the case or screw type mounting bracket could be damaged. The torque should be 0.12N•m.

Mount the controller vertically to the flat, rigid panel to ensure it adheres to the Dust-proof/Drip-proof specification (IP66).

Mounting panel thickness: 1 to 8mm.

Insert the instrument from the front side of the panel.

Attach the mounting bracket by the holes at the top and bottom of the case and secure in place with the screws.

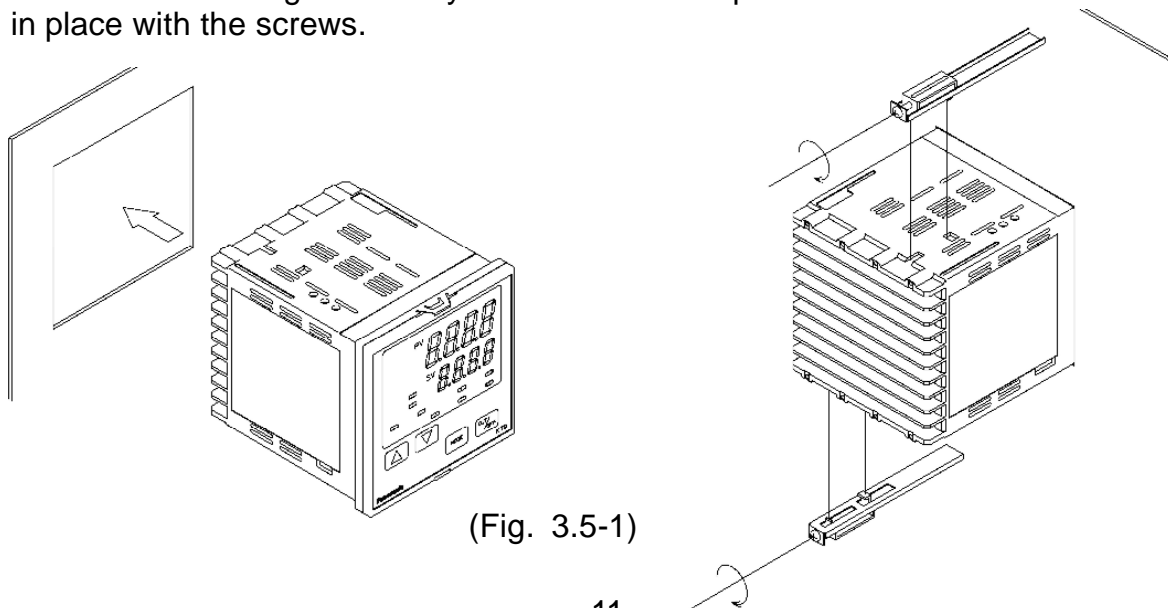

(Fig. 3.5-1)

4. Wiring



Warning

Turn the power supply to the instrument off before wiring or checking.
 Working on or touching the terminal with the power switched on may result in severe injury or death due to Electric Shock.
 Moreover, the instrument must be grounded before the power supply to the instrument is turned on.

4.1 Terminal arrangement

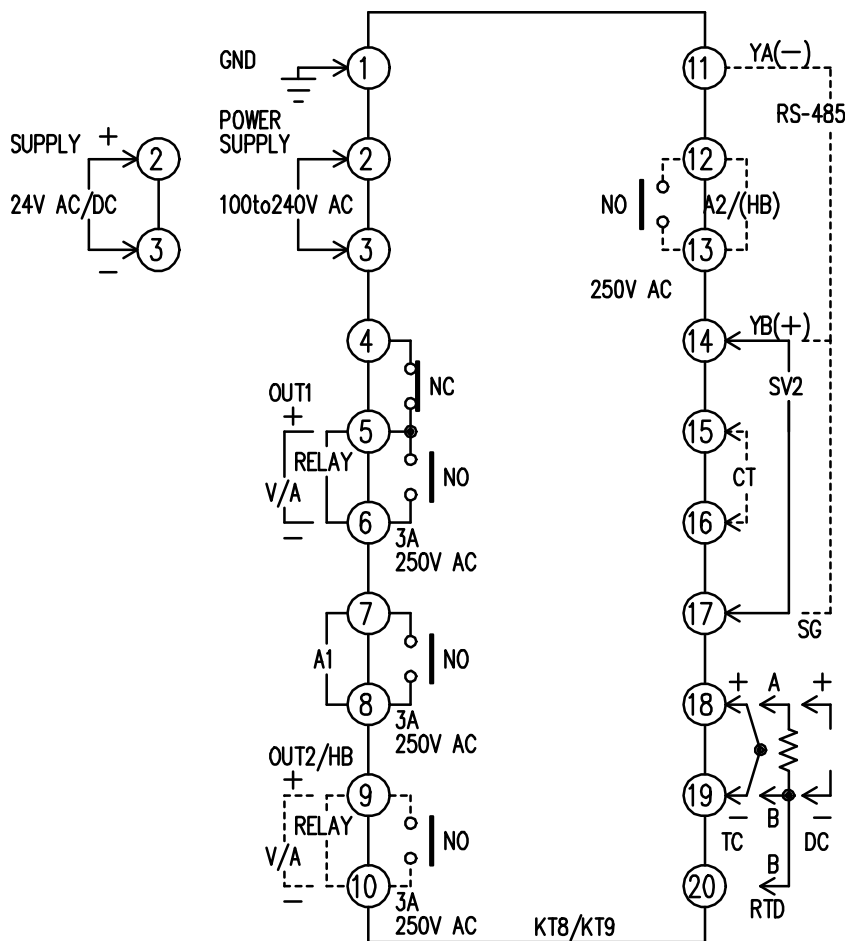

(Fig. 4.1-1)

- OUT1 : Control output 1 (Heating output)
 - OUT2 : Control output 2 (Cooling output)
 - RELAY : Relay contact output
 - V/A : Non-contact voltage output/DC current output
 - A1 : Alarm 1 output
 - A2 : Alarm 2 output
 - HB : Heater burnout alarm output
 - RS-485: Serial communication
 - SV2 : 2nd SV
 - CT : CT input
 - TC : Thermocouple
 - RTD : Resistance temperature detector
 - DC : DC current or DC voltage
- For DC current input, 50Ω shunt resistor (AKT4810, sold separately) must be connected between input terminals.

Notice

- The terminal block of KT9 series is designed to be wired from the left side. The lead wire must be inserted from the left side of the terminal, and fastened with the terminal screw.
- Dotted lines show options.
- If A2 (option) and Heater burnout alarm (option) are applied together, use terminals 12-13 for A2, and 9-10 for the Heater burnout alarm.
- If the Heating/Cooling control (option) and Heater burnout alarm (option) are applied together, use terminals 9-10 for the Heating/Cooling control, and 12-13 for the Heater burnout alarm.
- When only Heater burnout alarm option is applied, use terminals 9 and 10.

● Lead wire solderless terminal

Use a solderless terminal with an insulation sleeve in which an M3 screw fits as shown below.

Solderless terminal	Manufacturer	Model	Tightening torque
Y type	Nichifu Terminal Industries CO.,LTD.	TMEV1.25Y-3	0.63N•m
	Japan Solderless Terminal MFG CO.,LTD.	VD1.25-B3A	
Round type	Nichifu Terminal Industries CO.,LTD.	TMEV1.25-3	
	Japan Solderless Terminal MFG CO.,LTD.	V1.25-3	

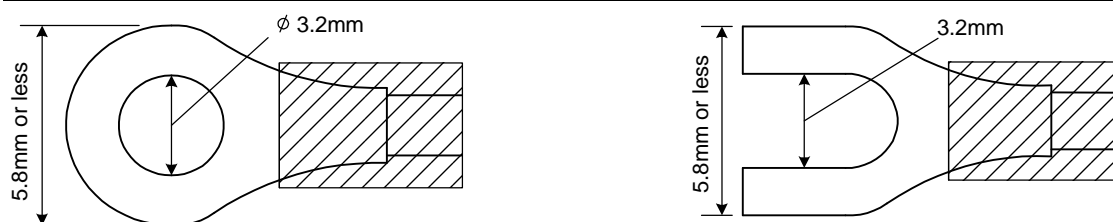

(Fig. 4.1-2)

4.2 Wiring examples

Notice

- To extend a thermocouple's lead wire, be sure to use a compensating lead wire in accordance with the sensor input specification. (If any other compensating lead wire is used, a temperature indication error may be caused.)
- Use the 3-wire RTD according to the sensor input specifications of this controller.
- This controller does not have built-in power switch, circuit breaker or fuse. It is necessary to install them in the circuit externally, near the controller. (Recommended fuse: Time-lag fuse, rated voltage 250V AC, rated current 2A)
- For a 24V AC/DC power source, do not confuse polarity when using direct current (DC).
- When using a relay contact output type, use a relay externally according to the capacity of the load to protect the built-in relay contact.
- When wiring, keep the input wire (Thermocouple, RTD, etc.) away from AC sources or load wires to avoid external interference.
- Use a thick wire (1.25 to 2.0mm²) for grounding.

[Heater burnout alarm output]

- (1) This alarm is not available for detecting heater current under phase control.
- (2) This alarm is not available for detecting 3-phase heater current.
- (3) Use the current transformer (CT) provided, and pass one lead wire of the heater circuit into the hole of the CT.
- (4) When wiring, keep CT wire away from any AC source and load wire to avoid external interference.
- (5) Solder the CT and wires connected to the CT input terminals. (There is no polarity.)

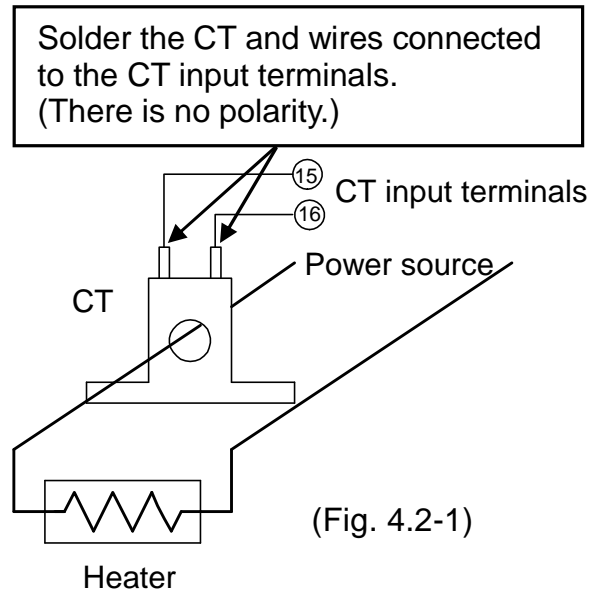

[AKT911100]

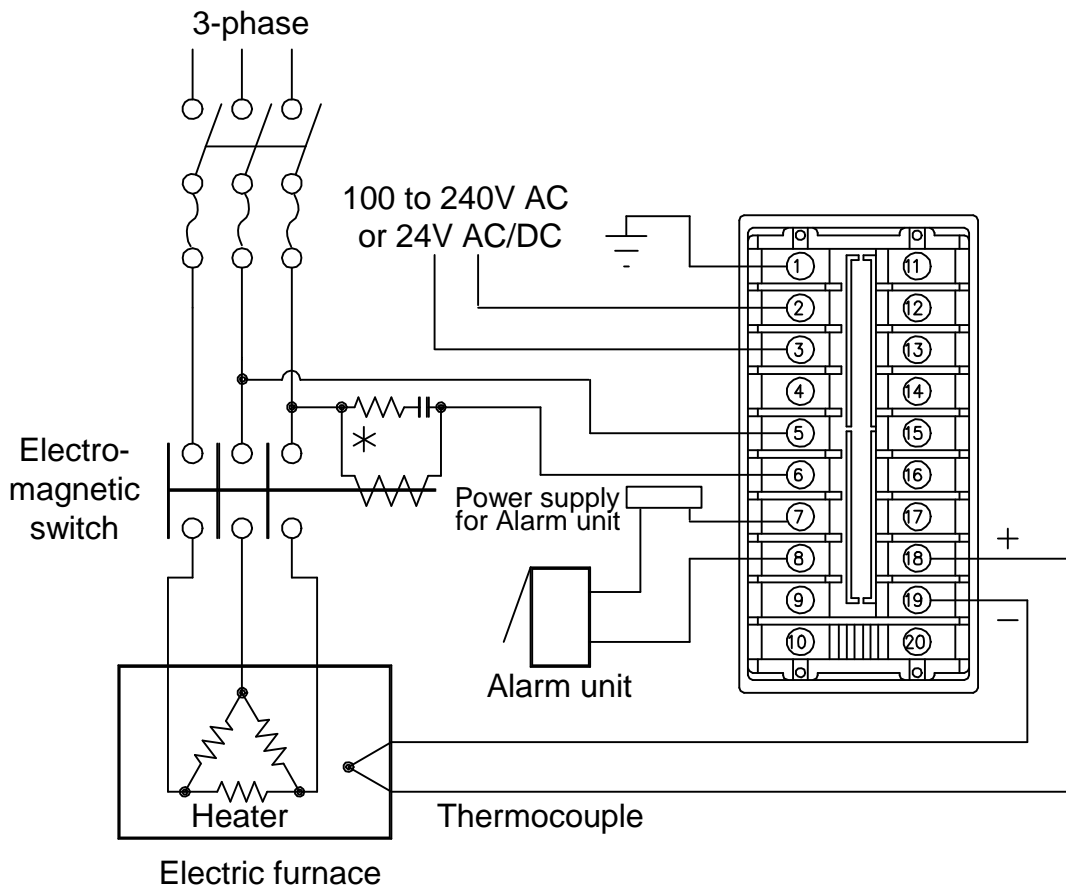

(Fig. 4.2-2)

- * To prevent the unit from harmful effects of unexpected high level noise, it is recommended that a surge absorber be installed between the electromagnetic switch coils.
- For a 24V AC/DC power source, do not confuse polarity when using direct current (DC).

5. Setup

For the thermocouple and RTD input, the sensor input characters and temperature unit are indicated on the PV display and the input range high limit value is indicated on the SV display for approx. 3 seconds after the power is turned on. See (Table 5-1).

For DC input, the sensor input characters are indicated on the PV display and the scaling high limit value is indicated on the SV display. See (Table 5-1).

If any other value is set during the scaling high limit setting, the set value is indicated on the SV display.

During this time, all outputs and the LED indicators are in OFF status.

Control will then start and the PV (process variable) will be indicated on the PV display and SV1 or SV2 will be indicated on the SV display.

While control output OFF function is working, $\square FF$ is indicated on the PV display.

To release the function, press the OUT/OFF key for approx. 1 second.

(Table 5-1)

Sensor input	°C		°F	
	PV display	SV display	PV display	SV display
K	$e \ C$	1370	$e \ F$	2500
	$e \ .C$	4000	$e \ .F$	7500
J	$d \ C$	1000	$d \ F$	1800
R	$r \ C$	1760	$r \ F$	3200
S	$y \ C$	1760	$y \ F$	3200
B	$b \ C$	1820	$b \ F$	3300
E	$e \ C$	800	$e \ F$	1500
T	$r \ .C$	4000	$r \ .F$	7500
N	$n \ C$	1300	$n \ F$	2300
PL-II	$PL2C$	1390	$PL2F$	2500
C (W/Re5-26)	$c \ C$	2315	$c \ F$	4200
Pt100	$Pt \ C$	8500	$Pt \ F$	9999
	$Pt \ C$	850	$Pt \ F$	1500
JPt100	$JPt \ C$	5000	$JPt \ F$	9000
	$JPt \ C$	500	$JPt \ F$	900
4 to 20mA DC	$420A$	Scaling high limit value		
0 to 20mA DC	$020A$			
0 to 1V DC	$0 \ 1V$			
0 to 10V DC	$0 \ 10V$			
1 to 5V DC	$1 \ 5V$			
0 to 5V DC	$0 \ 5V$			

5.1 Operation flow chart

Outline of operation procedure

Operation before running

- [Step 1 Initial setting]** : Set Input type, Alarm type, control action, etc. in Auxiliary function setting mode 2.
- [Step 2 Adjusting item]** : Set PID values and Alarm values in the Sub setting mode.
- [Step 3 Lock setting]** : Set the Set value Lock, SV high limit and SV low limit in Auxiliary function setting mode 1 (If Step 3 is not necessary, skip this step.)
- [Step 4 Run setting]** : Set SV1 (desired value) in the Main setting mode.

Alarm 1 (A1) setting procedure

[Numbers (1) to (5) are indicated on the flow chart.]

- (1) [A1 type]: Select an alarm type
[If an alarm type except for ----- is selected, items (2) to (5) are indicated and they can be set if necessary.]
- (2) [A1 action Energized/Deenergized]: Select Alarm 1 contact output ON (Energized: *energized*) or OFF (Deenergized: *deenergized*).
- (3) [A1 hysteresis]: Set A1 hysteresis.
- (4) [A1 action delayed timer]: Set A1 action delayed time.
(If input enters alarm action range and setting times has passed, the alarm is activated.)
- (5) [A1 value]: Set action point of A1 output.

[Note] If an alarm type is changed, the alarm set value becomes 0 (0.0). Therefore it is necessary to reset it.

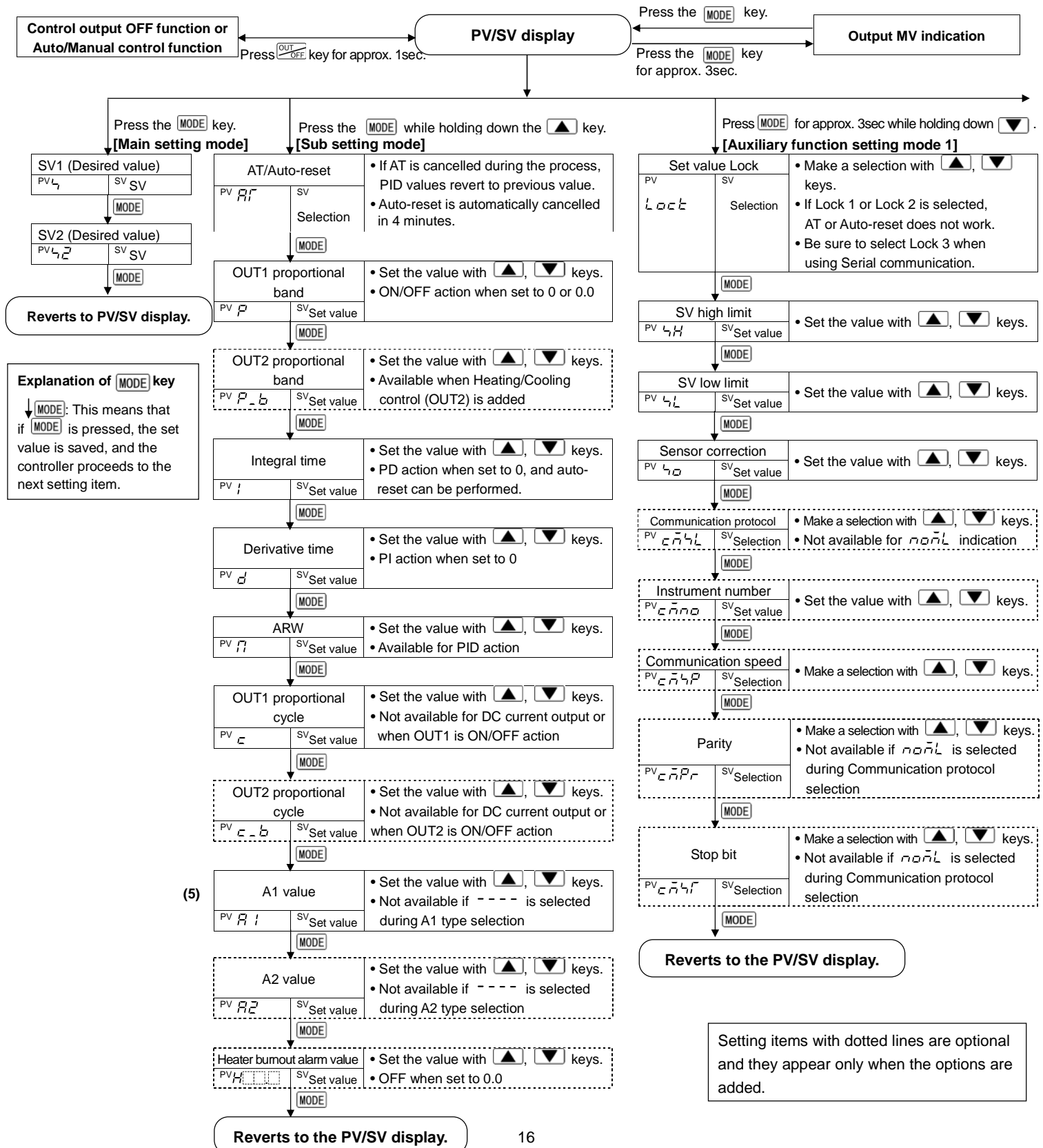

Explanation of MODE key

↓ **MODE**: This means that if **MODE** is pressed, the set value is saved, and the controller proceeds to the next setting item.

Setting items with dotted lines are optional and they appear only when the options are added.

Input type (character indication) and range	
K -200 to 1370 °C: <i>ℓ ℓ ℓ ℓ</i>	K -320 to 2500 °F: <i>ℓ ℓ ℓ ℓ</i>
-199.9 to 400.0 °C: <i>ℓ ℓ ℓ ℓ</i>	-199.9 to 750.0 °F: <i>ℓ ℓ ℓ ℓ</i>
J -200 to 1000 °C: <i>ℓ ℓ ℓ ℓ</i>	J -320 to 1800 °F: <i>ℓ ℓ ℓ ℓ</i>
R 0 to 1760 °C: <i>ℓ ℓ ℓ ℓ</i>	R 0 to 3200 °F: <i>ℓ ℓ ℓ ℓ</i>
S 0 to 1760 °C: <i>ℓ ℓ ℓ ℓ</i>	S 0 to 3200 °F: <i>ℓ ℓ ℓ ℓ</i>
B 0 to 1820 °C: <i>ℓ ℓ ℓ ℓ</i>	B 0 to 3300 °F: <i>ℓ ℓ ℓ ℓ</i>
E -200 to 800 °C: <i>ℓ ℓ ℓ ℓ</i>	E -320 to 1500 °F: <i>ℓ ℓ ℓ ℓ</i>
T -199.9 to 400.0 °C: <i>ℓ ℓ ℓ ℓ</i>	T -199.9 to 750.0 °F: <i>ℓ ℓ ℓ ℓ</i>
N -200 to 1300 °C: <i>ℓ ℓ ℓ ℓ</i>	N -320 to 2300 °F: <i>ℓ ℓ ℓ ℓ</i>
PL-II 0 to 1390 °C: <i>ℓ ℓ ℓ ℓ</i>	PL-II 0 to 2500 °F: <i>ℓ ℓ ℓ ℓ</i>
C(W/Re5-26) 0 to 2315 °C: <i>ℓ ℓ ℓ ℓ</i>	C(W/Re5-26) 0 to 4200 °F: <i>ℓ ℓ ℓ ℓ</i>
Pt100 -199.9 to 850.0 °C: <i>ℓ ℓ ℓ ℓ</i>	Pt100 -199.9 to 999.9 °F: <i>ℓ ℓ ℓ ℓ</i>
JPt100 -199.9 to 500.0 °C: <i>ℓ ℓ ℓ ℓ</i>	JPt100 -199.9 to 900.0 °F: <i>ℓ ℓ ℓ ℓ</i>
Pt100 -200 to 850 °C: <i>ℓ ℓ ℓ ℓ</i>	Pt100 -300 to 1500 °F: <i>ℓ ℓ ℓ ℓ</i>
JPt100 -200 to 500 °C: <i>ℓ ℓ ℓ ℓ</i>	JPt100 -300 to 900 °F: <i>ℓ ℓ ℓ ℓ</i>
4 to 20mA DC -1999 to 9999: <i>420R</i>	
0 to 20mA DC -1999 to 9999: <i>020R</i>	
0 to 1V DC -1999 to 9999: <i>0 1V</i>	
0 to 5V DC -1999 to 9999: <i>0 5V</i>	
1 to 5V DC -1999 to 9999: <i>1 5V</i>	
0 to 10V DC -1999 to 9999: <i>0 10V</i>	

Alarm type	
High limit alarm: The alarm action is \pm deviation setting from the SV. The alarm is activated if the input value reaches the high limit set value. Character indication: <i>H</i>	
Low limit alarm: The alarm action is \pm deviation setting to the SV. The alarm is activated if the input value goes under the low limit set value. Character indication: <i>L</i>	
High/Low limits alarm: Combines High limit and Low limit alarm actions. When input value reaches high limit set value or goes under the low limit set value, the alarm is activated. Character indication: <i>HL</i>	
High/Low limit range alarm: When input value is between the high limit set value and low limit set value, the alarm is activated. Character indication: <i>HLR</i>	
Process alarm: Within the scale range of the controller, alarm action points can be set at random and if the input reaches the randomly set action point, the alarm is activated. Character indication: Process high alarm <i>PH</i> , Process low alarm <i>PL</i>	
Alarm with standby function: When the power to the controller is turned on, even if the input enters the alarm action range, the alarm is not activated. (If the controller is allowed to keep running, once the input exceeds the alarm action point, the standby function will be released.) Character indication: High limit alarm with standby : <i>H L</i> , Low limit alarm with standby : <i>L L</i> , High/Low limits alarm with standby : <i>HL L</i>	

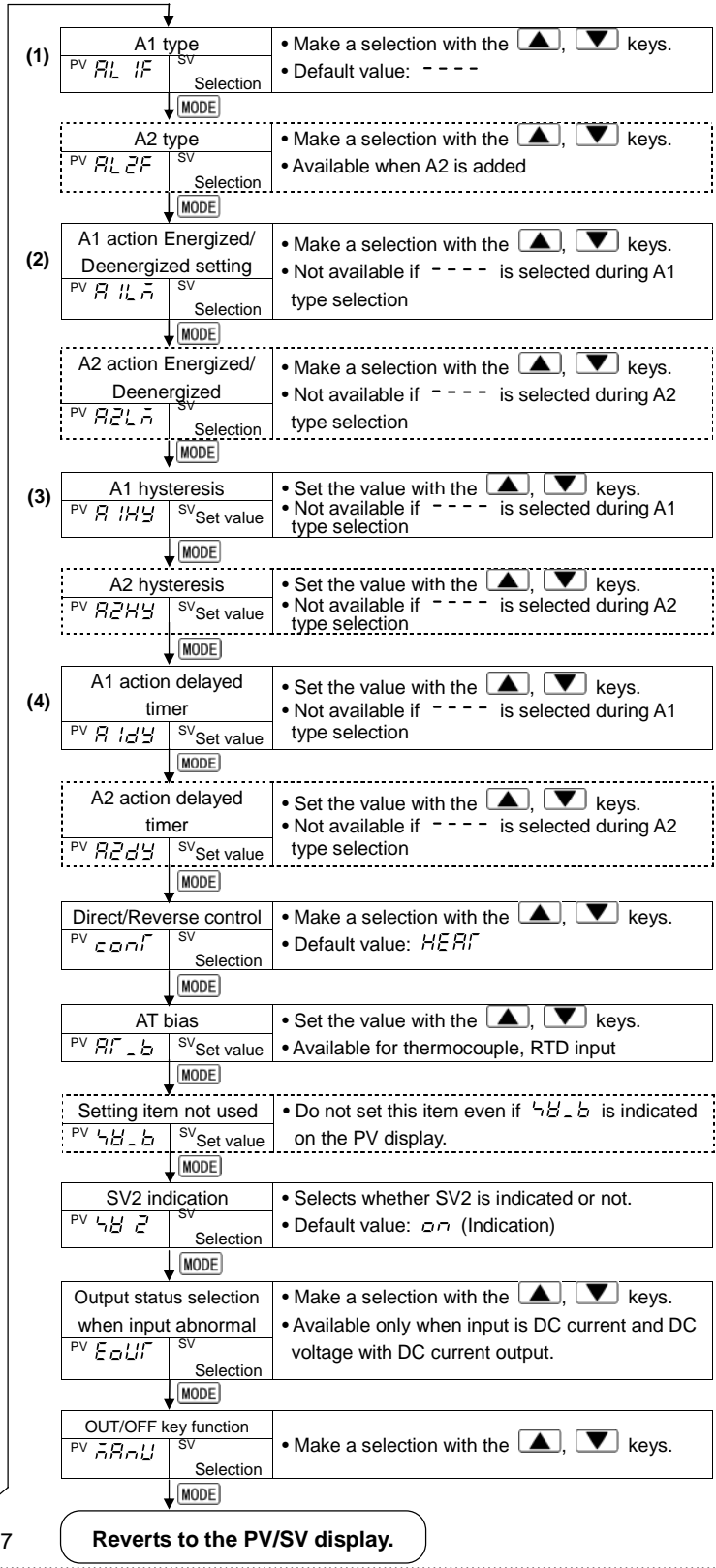
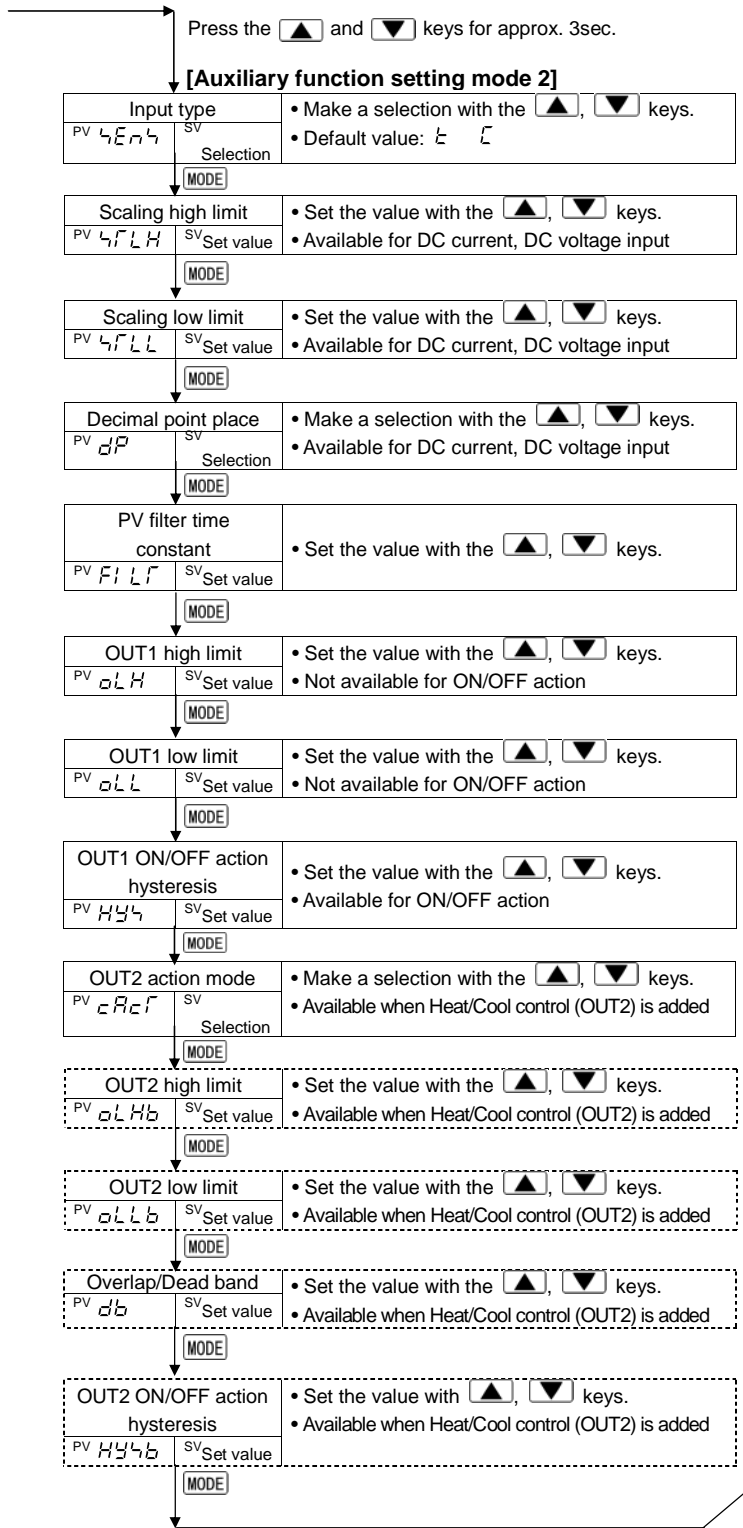

5.2 Main setting mode

The main setting mode can be selected by pressing the **MODE** key.

The SV can be increased or decreased by pressing the **▲** or **▼** key.

The SV is registered by pressing the **MODE** key, and the unit reverts to the PV/SV display mode.

Character (PV display)	Name, Function, Setting range	Default value (SV display)
4	SV1 <ul style="list-style-type: none"> • Sets SV1. • Setting range: SV low limit to SV high limit, or scaling low limit value to scaling high limit value 	0°C
4.2	SV2 <ul style="list-style-type: none"> • Sets SV2. • Not available if Serial communication (option) is added. • Setting range: SV low limit to SV high limit, or scaling low limit value to scaling high limit value 	0°C

5.3 Output MV indication

Output MV (manipulated variable) indication

- In the PV/SV display mode, if the **MODE** key is pressed for 3 seconds, the output MV is indicated on the SV display.

While the output MV is indicated, the 1st decimal point from the right on the SV display flashes in 0.5 second cycles.

By pressing the **MODE** key again, the unit reverts to the PV/SV display mode.

5.4 Sub setting mode

The sub setting mode can be selected by pressing the **MODE** key while holding down the **▲** key.

The set value can be increased or decreased by pressing the **▲** or **▼** key.

The set value is registered by pressing the **MODE** key, then the next setting item is selected.

Character (PV display)	Name, Function, Setting range	Default value (SV display)
AT	AT setting/Auto-reset setting <ul style="list-style-type: none"> • Sets AT (auto-tuning) or Auto-reset (offset correction). • Auto-reset can be performed only in PD or P action. (Auto-reset cannot be performed when the control action is PID, PI or ON/OFF action) • - - - - : Auto-tuning/Auto-reset Cancel AT□□/R4ET : Auto-tuning/Auto-reset Perform [Auto-tuning] <ul style="list-style-type: none"> • If Auto-tuning "Perform" is selected and the MODE key is pressed, the AT indicator flashes and the unit reverts to the PV/SV display mode. • When Auto-tuning is finished, the AT indicator is turned off and P, I, D, ARW values are automatically set. • During auto-tuning, none of the settings can be carried out. • If Auto-tuning is cancelled during the process, P, I, D, ARW values return to the previous value. • If OUT/OFF key is pressed during auto-tuning, control output OFF function activates, and pressing the OUT/OFF key again cancels the PID auto-tuning. • If PID auto-tuning does not finish in 4 hours after starting, PID auto-tuning is cancelled automatically. 	Cancel

	<p>[Auto-reset]</p> <ul style="list-style-type: none"> • If auto-reset “Perform” is selected and the MODE key is pressed, the AT indicator flashes and the unit reverts to the PV/SV display mode. • If auto-reset is performed, offset correction immediately starts. • To prevent key misoperation, other settings cannot be performed for 4 minutes after auto-reset starts. • After auto-reset is completed, the AT indicator is turned off and the reset value is automatically set. 	
<i>P</i>	<p>OUT1 proportional band setting</p> <ul style="list-style-type: none"> • Sets OUT1 proportional band. The control action becomes ON/OFF action when set to 0 or 0.0. • Setting range: 0 to 1000°C (0 to 2000°F) With a decimal point, 0.0 to 999.9°C (°F), DC input: 0.0 to 100.0% [Percentage of the scaling span (scaling high limit-scaling low limit)] 	10°C
<i>P_b</i>	<p>OUT2 proportional band setting</p> <ul style="list-style-type: none"> • Sets OUT2 proportional band. OUT2 becomes ON/OFF action when set to 0.0. • Available only when Heating/Cooling control (option) is added. • Setting range: 0.0 to 10.0 (multiplying factor to OUT1 proportional band) 	1.0 times
<i>I</i>	<p>Integral time setting</p> <ul style="list-style-type: none"> • Sets the integral time. Setting the value to 0 disables the function (PD action). • Setting range: 0 to 1000 seconds 	200 seconds
<i>D</i>	<p>Derivative time setting</p> <ul style="list-style-type: none"> • Sets the derivative time. Setting the value to 0 disables the function (PI action). • Setting range: 0 to 300 seconds 	50 seconds
<i>n</i>	<p>ARW (Anti-reset windup) setting</p> <ul style="list-style-type: none"> • Sets the anti-reset windup. • Available only for PID action. • Setting range: 0 to 100% 	50%
<i>c</i>	<p>OUT1 proportional cycle setting</p> <ul style="list-style-type: none"> • Sets OUT1 proportional cycle. <p>Not available for ON/OFF action and DC current output type</p> <ul style="list-style-type: none"> • With the relay contact output type, if the proportional cycle time is decreased, the frequency of the relay action increases and the life of the relay contact is shortened. • Setting range: 1 to 120 seconds 	Relay contact output: 30sec Non-contact voltage output: 3sec
<i>c_b</i>	<p>OUT2 proportional cycle setting</p> <ul style="list-style-type: none"> • Sets OUT2 proportional cycle. <p>Not available for ON/OFF action and DC current output type</p> <ul style="list-style-type: none"> • Available only when Heating/Cooling control (option) is added. • Setting range: 1 to 120 seconds 	Relay contact output: 30sec Non-contact voltage output: 3sec

A1	A1 value setting <ul style="list-style-type: none"> • Sets the action point for A1 output. Setting the value to 0 or 0.0 disables the function. (excluding Process high and Process low alarm) • Not available if No alarm action is selected during A1 type selection. • Setting range: See (Table 5.4-1). 	0°C
A2	A2 value setting <ul style="list-style-type: none"> • Sets the action point for A2 output. Setting the value to 0 or 0.0 disables the function. (excluding Process high and low alarm) • Not available if A2 (option) is not added or if No alarm action is selected during A2 type selection. • Setting range and default value are the same as those of A1 value setting. 	0°C
 and measured current value are displayed alternately.	HB (Heater burnout alarm) value setting <ul style="list-style-type: none"> • Sets the heater current value for Heater burnout alarm. • Available only when the Heater burnout alarm (option) is added. • When OUT1 is OFF, heater current value shows the previous value as when OUT1 was ON. • Setting the value to 0.0 disables the function. It is recommended to set approx. 80% of the heater current value (set value) considering the voltage fluctuation. • Upon returning to set limits, the alarm will stop. • Setting range: Rating 5A: 0.0 to 5.0A Rating 10A: 0.0 to 10.0A Rating 20A: 0.0 to 20.0A Rating 50A: 0.0 to 50.0A 	0.0A

Setting range of A1 and A2

(Table 5.4-1)

Alarm type	Setting range
High limit alarm	–Input span to input span °C (°F) *1
Low limit alarm	–Input span to input span °C (°F) *1
High/Low limits alarm	0 to input span °C (°F) *1
High/Low limit range alarm	0 to input span °C (°F) *1
Process high alarm	Input range low limit to input range high limit *2
Process low alarm	Input range low limit to input range high limit *2
High limit alarm with standby	–Input span to input span °C (°F) *1
Low limit alarm with standby	–Input span to input span °C (°F) *1
High/Low limits alarm with standby	0 to input span °C (°F) *1

- When the input has a decimal point, negative low limit value is –199.9, and positive high limit value is 999.9.



- All alarm types except Process alarm are ± deviation setting from the SV.

*1: For DC input, the input span is the same as the scaling span.

*2: For DC input, input range low (or high) limit value is the same as the scaling low (or high) limit value.

5.5 Auxiliary function setting mode 1



In the PV/SV display mode, if the  key is pressed for approx. 3 seconds while holding down the  key, Auxiliary function setting mode 1 can be selected.



The set value can be increased or decreased by pressing the  or  key. If the  key is pressed, the set value is registered and the next setting item is selected.

Character (PV display)	Name, Function, Setting range	Default value (SV display)
<i>L o c k</i>	Set value lock selection <ul style="list-style-type: none"> Locks the set value to prevent setting errors The setting item to be locked depends on the selection. PID auto-tuning or auto-reset does not work if Lock 1 or Lock 2 is selected. When selecting Lock, select Lock 1, Lock 2 or Lock 3 after setting the necessary items in the status Unlock. ---- (Unlock): All set values are changeable. <i>L o c 1</i> (Lock 1): None of the set values can be changed. <i>L o c 2</i> (Lock 2): Only main setting mode can be changed. <i>L o c 3</i> (Lock 3): All set values except input type can be changed. However, they return to their previous value after the power is turned off because they are not written in the non-volatile memory. Be sure to use Lock 3 when changing the set value frequently via communication. (If the value changed by the communication function is the same as the previous one, it is not written in the non-volatile memory.) Do not change any setting item in Auxiliary function setting mode 2. If any item in the mode is changed, it will affect other setting items such as SV and Alarm value. 	Unlock
<i>4H</i>	SV high limit setting <ul style="list-style-type: none"> Sets SV high limit. Setting range: SV low limit to input range high limit value DC input: SV low limit to scaling high limit value (The placement of the decimal point follows the selection) 	1370°C
<i>4L</i>	SV low limit setting <ul style="list-style-type: none"> Sets SV low limit. Setting range: Input range low limit value to SV high limit DC input: Scaling low limit value to SV high limit (The placement of the decimal point follows the selection) 	-200°C
<i>40</i>	Sensor correction setting <ul style="list-style-type: none"> Sets correction value for the sensor. Setting range: -100.0 to 100.0°C (°F), For DC input, -1000 to 1000 (The placement of the decimal point follows the selection) 	0.0°C
<i>c n 4 L</i>	Communication protocol selection <ul style="list-style-type: none"> Selects the communication protocol. Available only when Serial communication (option) is applied. Not available if <i>n o n L</i> is indicated Modbus ASCII mode: <i>n o d A</i>, Modbus RTU mode: <i>n o d r</i> 	<i>n o d A</i>
<i>c n n 0</i>	Instrument number setting <ul style="list-style-type: none"> Sets the instrument number. (Communication cannot be carried out unless an instrument number is individually set when communicating by connecting plural instruments in serial communication.) Available only when Serial communication (option) is added. Setting range: 0 to 95 	0
<i>c n 4 P</i>	Communication speed selection <ul style="list-style-type: none"> Selects a speed equal to that of the host computer. (Communication cannot be performed unless the speeds are equal) Available only when Serial communication (option) is added. 2400bps: <i>24</i>, 4800bps: <i>48</i>, 9600bps: <i>96</i>, 19200bps: <i>192</i> 	9600bps

$\bar{c}\bar{n}P_r$	Parity selection • Selects the parity. • Not available if Serial communication (option) is not added or if $n\bar{o}\bar{n}L$ is selected during Communication protocol selection. • No parity: $n\bar{o}\bar{n}E$, Even parity: $E\bar{b}E\bar{n}$, Odd parity: $o\bar{d}\bar{d}$	Even parity
$\bar{c}\bar{n}4_i$	Stop bit selection • Selects the stop bit. • Not available if Serial communication (option) is not added or if $n\bar{o}\bar{n}L$ is selected during Communication protocol selection. • Selecting item: i (1) or \bar{e} (2)	1

5.6 Auxiliary function setting mode 2

In the PV/SV display mode, if the  and  keys are pressed for approx. 3 seconds, Auxiliary function setting mode 2 can be selected.

The set value can be increased or decreased by pressing the  or  key. If the **MODE** key is pressed, the set value is registered and the next setting item is selected.

Character (PV display)	Name, Function, Setting range	Default value (SV display)
$4E\bar{n}4$	Input type selection • The input type can be selected from thermocouple (10 types), RTD (2 types), DC current (2 types) and DC voltage (4 types) and the unit °C/°F.	K (–200 to 1370°C)
Input type	Input range	
K	–200 to 1370 °C: $\bar{e} \bar{L}$	–320 to 2500 °F: $\bar{e} \bar{F}$
	–199.9 to 400.0 °C: $\bar{e} \bar{.L}$	–199.9 to 750.0 °F: $\bar{e} \bar{.F}$
J	–200 to 1000 °C: $\bar{j} \bar{L}$	–320 to 1800 °F: $\bar{j} \bar{F}$
R	0 to 1760 °C: $\bar{r} \bar{L}$	0 to 3200 °F: $\bar{r} \bar{F}$
S	0 to 1760 °C: $\bar{s} \bar{L}$	0 to 3200 °F: $\bar{s} \bar{F}$
B	0 to 1820 °C: $\bar{b} \bar{L}$	0 to 3300 °F: $\bar{b} \bar{F}$
E	–200 to 800 °C: $\bar{e} \bar{L}$	–320 to 1500 °F: $\bar{e} \bar{F}$
T	–199.9 to 400.0 °C: $\bar{t} \bar{L}$	–199.9 to 750.0 °F: $\bar{t} \bar{F}$
N	–200 to 1300 °C: $\bar{n} \bar{L}$	–320 to 2300 °F: $\bar{n} \bar{F}$
PL-II	0 to 1390 °C: $\bar{P}\bar{L}\bar{2}\bar{L}$	0 to 2500 °F: $\bar{P}\bar{L}\bar{2}\bar{F}$
C(W/Re5-26)	0 to 2315 °C: $\bar{c} \bar{L}$	0 to 4200 °F: $\bar{c} \bar{F}$
Pt100	–199.9 to 850.0 °C: $\bar{P}\bar{T}\bar{L}$	–199.9 to 999.9 °F: $\bar{P}\bar{T}\bar{F}$
	–200 to 850 °C: $\bar{P}\bar{T}\bar{L}$	–300 to 1500 °F: $\bar{P}\bar{T}\bar{F}$
JPt100	–199.9 to 500.0 °C: $\bar{J}\bar{P}\bar{T}\bar{L}$	–199.9 to 900.0 °F: $\bar{J}\bar{P}\bar{T}\bar{F}$
	–200 to 500 °C: $\bar{J}\bar{P}\bar{T}\bar{L}$	–300 to 900 °F: $\bar{J}\bar{P}\bar{T}\bar{F}$
4 to 20mA DC	–1999 to 9999: $420A$	
0 to 20mA DC	–1999 to 9999: $020A$	
0 to 1V DC	–1999 to 9999: $0 1B$	
0 to 10V DC	–1999 to 9999: $0 10B$	
1 to 5V DC	–1999 to 9999: $1 5B$	
0 to 5V DC	–1999 to 9999: $0 5B$	

4FLH	Scaling high limit setting <ul style="list-style-type: none"> • Sets scaling high limit value. • Available only for the DC input • Setting range: Scaling low limit value to input range high limit value (The placement of the decimal point follows the selection) 	9999
4FL L	Scaling low limit setting <ul style="list-style-type: none"> • Sets scaling low limit value. • Available only for the DC input • Setting range: Input range low limit value to scaling high limit value (The placement of the decimal point follows the selection) 	-1999
dP	Decimal point place selection <ul style="list-style-type: none"> • Selects a decimal point place. • Available only for the DC input • No decimal point : 1 digit after decimal point : 2 digits after decimal point: 3 digits after decimal point: 	No decimal point
FILT	PV filter time constant setting <ul style="list-style-type: none"> • Sets PV filter time constant. If the value is set too large, it adversely affects control result due to the delay of response. • Setting range: 0.0 to 10.0 seconds 	0.0 seconds
oLH	OUT1 high limit setting <ul style="list-style-type: none"> • Sets the high limit value of OUT1. Not available if OUT1 is ON/OFF action • Setting range: OUT1 low limit value to 105% Setting higher than 100% is effective to DC current output type. 	100%
oL L	OUT1 low limit setting <ul style="list-style-type: none"> • Sets the low limit value of OUT1. Not available if OUT1 is ON/OFF action • Setting range: -5% to OUT1 high limit value Setting less than 0% is effective to DC current output type. 	0%
H44	OUT1 ON/OFF action hysteresis setting <ul style="list-style-type: none"> • Sets ON/OFF action hysteresis for OUT1. Available only when OUT1 is ON/OFF action • Setting range: 0.1 to 100.0°C (°F) For DC input, 1 to 1000 (The placement of the decimal point follows the selection) 	1.0°C
cRcF	OUT2 action mode selection <ul style="list-style-type: none"> • Selects a cooling action from Air cooling, Oil cooling and Water cooling. Not available if OUT2 is ON/OFF action or if Heating/Cooling control (option) is not applied • <i>Air</i> : Air cooling (Linear characteristic) <i>Oil</i> : Oil cooling (The 1.5th power of the linear characteristic) <i>Water</i> : Water cooling (The 2nd power of the linear characteristic) 	Air cooling

<i>oLHb</i>	OUT2 high limit setting <ul style="list-style-type: none"> • Sets the high limit value of OUT2. • Not available if OUT2 is ON/OFF action or if Heating/Cooling control (option) is not applied • Setting range: OUT2 low limit value to 105% (Setting higher than 100% is effective to DC current output type.) 	100%																				
<i>oLLb</i>	OUT2 low limit setting <ul style="list-style-type: none"> • Sets the low limit value of OUT2. • Not available if OUT2 is ON/OFF action or if Heating/Cooling control (option) is not applied • Setting range: -5% to OUT2 high limit value (Setting less than 0% is effective to DC current output type.) 	0%																				
<i>db</i>	Overlap band/Dead band setting <ul style="list-style-type: none"> • Sets overlap band and dead band value for OUT1 and OUT2. + Set value: Dead band - Set value: Overlap band • Not available if OUT2 is ON/OFF action or if Heating/Cooling control (option) is not applied • Setting range: -100.0 to 100.0°C (°F) DC input: -1000 to 1000 (The placement of the decimal point follows the selection) 	0.0°C																				
<i>H44b</i>	OUT2 ON/OFF action hysteresis setting <ul style="list-style-type: none"> • Sets ON/OFF action hysteresis for OUT2. • Available when OUT2 is ON/OFF action or when Heating/Cooling control (option) is applied • Setting range: 0.1 to 100.0°C (°F) For DC input, 1 to 1000 (The placement of the decimal point follows the selection) 	1.0°C																				
<i>AL IF</i>	A1 type selection <ul style="list-style-type: none"> • Selects A1 type. • Selecting item <table style="width: 100%; border: none;"> <tr> <td>No alarm action</td> <td style="text-align: right;">: - - - -</td> </tr> <tr> <td>High limit alarm</td> <td style="text-align: right;">: H</td> </tr> <tr> <td>Low limit alarm</td> <td style="text-align: right;">: L</td> </tr> <tr> <td>High/Low limits alarm</td> <td style="text-align: right;">: HL</td> </tr> <tr> <td>High/Low limit range alarm</td> <td style="text-align: right;">: $\bar{u}l\bar{d}$</td> </tr> <tr> <td>Process high alarm</td> <td style="text-align: right;">: P\bar{h}</td> </tr> <tr> <td>Process low alarm</td> <td style="text-align: right;">: $\bar{r}P\bar{h}$</td> </tr> <tr> <td>High limit alarm with standby</td> <td style="text-align: right;">: H \bar{u}</td> </tr> <tr> <td>Low limit alarm with standby</td> <td style="text-align: right;">: L \bar{u}</td> </tr> <tr> <td>High/Low limits alarm with standby:</td> <td style="text-align: right;">HL \bar{u}</td> </tr> </table>	No alarm action	: - - - -	High limit alarm	: H	Low limit alarm	: L	High/Low limits alarm	: HL	High/Low limit range alarm	: $\bar{u}l\bar{d}$	Process high alarm	: P \bar{h}	Process low alarm	: $\bar{r}P\bar{h}$	High limit alarm with standby	: H \bar{u}	Low limit alarm with standby	: L \bar{u}	High/Low limits alarm with standby:	HL \bar{u}	No alarm action
No alarm action	: - - - -																					
High limit alarm	: H																					
Low limit alarm	: L																					
High/Low limits alarm	: HL																					
High/Low limit range alarm	: $\bar{u}l\bar{d}$																					
Process high alarm	: P \bar{h}																					
Process low alarm	: $\bar{r}P\bar{h}$																					
High limit alarm with standby	: H \bar{u}																					
Low limit alarm with standby	: L \bar{u}																					
High/Low limits alarm with standby:	HL \bar{u}																					

<i>ALZF</i>	A2 type selection <ul style="list-style-type: none"> • Selects A2 type. • Available only when A2 (option) is applied • The selecting item is the same as those of A1 type selection. 	No alarm action
<i>A1Lā</i>	A1 action Energized/Deenergized selection <ul style="list-style-type: none"> • Selects A1 action Energized/Deenergized. • Not available if No alarm action is selected during A1 type selection • Selecting item Energized: <i>noāL</i> Deenergized: <i>rEBH</i> 	Energized
<i>A2Lā</i>	A2 action Energized/Deenergized selection <ul style="list-style-type: none"> • Selects A2 action Energized/Deenergized. • Not available if No alarm action is selected during A2 type selection or if A2 (option) is not added • The selecting item is the same as those of A1 action Energized/Deenergized selection. 	Energized
<i>A1HY</i>	A1 hysteresis setting <ul style="list-style-type: none"> • Sets A1 hysteresis. • Not available if No alarm action is selected during A1 type selection • Setting range: 0.1 to 100.0°C (°F) For DC input, 1 to 1000 (The placement of the decimal point follows the selection) 	1.0°C
<i>A2HY</i>	A2 hysteresis setting <ul style="list-style-type: none"> • Sets A2 hysteresis. • Not available if No alarm action is selected during A2 type selection or if A2 (option) is not added • The setting range is the same as those of A1 hysteresis setting. 	1.0°C
<i>A1dY</i>	A1 action delayed timer setting <ul style="list-style-type: none"> • Sets the action delayed timer for A1. The Alarm is activated when the setting time has elapsed after the input enters the alarm action range. • Not available if No alarm action is selected during A1 type selection • Setting range: 0 to 9999 seconds 	0 seconds
<i>A2dY</i>	A2 action delayed timer setting <ul style="list-style-type: none"> • Sets the action delayed timer for A2. The Alarm is activated when the setting time has elapsed after the input enters the alarm action range. • Not available if No alarm action is selected during A2 type selection or if A2 (option) is not added • The setting range is the same as those of A1 action delayed timer setting. 	0 seconds

<i>cool</i>	Direct/Reverse control action selection <ul style="list-style-type: none"> • Selects either Direct (Cooling) or Reverse (Heating) control action. • Selecting item Reverse (Heating): <i>HEAT</i> Direct (Cooling): <i>cool</i> 	Reverse (Heating) action
<i>AT_b</i>	AT bias setting <ul style="list-style-type: none"> • Sets the bias value for performing PID auto-tuning. • Not available for DC input Available for PID action • Setting range: 0 to 50°C (0 to 100°F) With a decimal point, 0.0 to 50.0°C (0.0 to 100.0°F) 	20°C
<i>yh_b</i>	Setting item not used When Serial communication (option) is applied, this item appears. However, do not set this item.	
<i>yh_2</i>	SV2 indication selection <ul style="list-style-type: none"> • Selects whether SV2 is indicated or not. • Selecting item <i>on</i> (Indication) <i>off</i> (No indication) 	Indication
<i>EOUF</i>	Output status selection when input abnormal <ul style="list-style-type: none"> • Selects the output status of OUT1 and OUT2 (option) when DC input is overscale or underscale. See “Input abnormality indication” on pages 40, 41. • Available only for DC current output with DC input • <i>off</i>: OFF(4mA) or OUT1(OUT2) low limit <i>on</i>: Outputs a value between OFF(4mA) and ON(20mA) or between OUT1(OUT2) low limit value and OUT1(OUT2) high limit value, depending on a deviation. 	Output OFF
<i>ARW</i>	OUT/OFF key function selection <ul style="list-style-type: none"> • Selects the OUT/OFF key function. • Selecting item <i>off</i> (OUT/OFF function), <i>ARW</i> (Auto/Manual control function) 	OUT/OFF function

ARW function

ARW (Anti-reset windup) prevents overshoot caused by the integral action. The smaller the ARW value, the less the overshoot caused by the integral action in the transition status, however it takes time until stabilization.

Sensor correction function

This corrects the input value from the sensor. When a sensor cannot be set at a location where control is desired, the sensor measuring temperature may deviate from the temperature in the controlled location. When controlling with plural controllers, the accuracy of sensors affects the control.

Therefore, sometimes the measured temperatures (input value) do not concur. In such a case, the control can be set at the desired temperature by adjusting the input value of sensors.

SV1/SV2 external selection

SV1 or SV2 can be selected by the external operation.

- Between terminals 14 and 17 open: SV1 can be selected.
- Between terminals 14 and 17 closed: SV2 can be selected.
- Set value memory number cannot be changed during setting mode or PID auto-tuning.

Energized/Deenergized function

This function is not available for the Heater burnout alarm (optional).

[If the alarm action Energized is selected]

When the alarm output indicator is lit, the alarm output (terminals 7-8 or 12-13) is conducted (ON). When the alarm output indicator is unlit, the alarm output is not conducted (OFF). See (Fig. 5.6-1).

[If the alarm action Deenergized is selected]

When the alarm output indicator is lit, the alarm output (terminals 7-8 or 12-13) is not conducted (OFF). When the alarm output indicator is unlit, the alarm output is conducted (ON). See (Fig. 5.6-2).

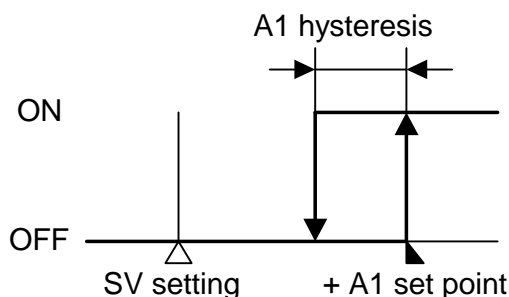

High limit alarm (When Energized is set)
(Fig. 5.6-1)

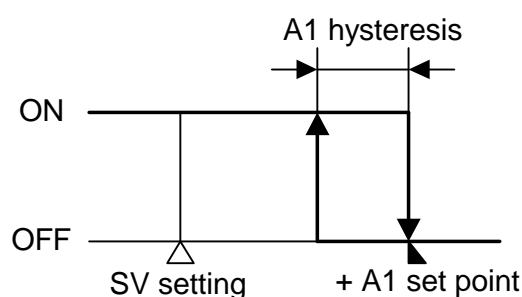

High limit alarm (When Deenergized is set)
(Fig. 5.6-2)

5.7 Control output OFF function

Control output OFF function [OUT/OFF]

- A function to pause the control action or turn the control output of the unused instrument of the plural units OFF even if the power to the instrument is supplied.

[OUT/OFF] is indicated on the PV display while the function is working.

- Once the Control output OFF function is enabled, the function cannot be released even if the power to the instrument is turned OFF and ON again.

To cancel the function, press the  key again for approx. 1 second.

5.8 Auto/Manual control function



PV/SV display

mode

(Manual control)

- To use this function, it is necessary to select Auto/Manual control function during the OUT/OFF key function selection.

- First, press the  key.

The MV (manipulated variable) on the SV display can be increased or decreased by pressing the  or  key and the control is performed.

- The 1st decimal point from the right on the SV display flashes.

- By pressing the  key again, the mode reverts to the PV/SV display (automatic control) mode.

(When the power supply to the instrument is turned on, automatic control starts)

6. Running

After the controller is mounted to the control panel and wiring is completed, operate the unit following the procedures below.

(1) Turn the power supply to the KT9 Series ON.

For approx. 3 seconds after the power is switched ON, sensor input characters and temperature unit are indicated on the PV display, and the input range high limit value is indicated on the SV display. See (Table 6-1).

For the DC input, for approx. 3 seconds after the power is switched ON, sensor input characters are indicated on the PV display, and the scaling high limit value is indicated on the SV display. See (Table 6-1).

However, if the scaling high limit value has been changed during the Scaling high limit setting, the changed value is indicated on the SV display.)

(During this time, all outputs and the LED indicators are in OFF status)

After that, the PV (process variable) is indicated on the PV display, and SV1 or SV2 is indicated on the SV display.

(When the Control output OFF function is working, "OFF" is indicated on the PV display)

(Table 6-1)

Sensor input	°C		°F	
	PV display	SV display	PV display	SV display
K	E L	1370	E F	2500
	E L	4000	E F	7500
J	J L	1000	J F	1800
R	r L	1760	r F	3200
S	s L	1760	s F	3200
B	b L	1820	b F	3300
E	E L	800	E F	1500
T	T L	4000	T F	7500
N	n L	1300	n F	2300
PL-II	PL2L	1390	PL2F	2500
C (W/Re5-26)	c L	2375	c F	4200
Pt100	PT L	8500	PT F	9999
	PT L	850	PT F	1500
JPt100	JPT L	5000	JPT F	9000
	JPT L	500	JPT F	900
4 to 20mA DC	420A	Scaling high limit value		
0 to 20mA DC	020A			
0 to 1V DC	0 18			
0 to 10V DC	0 108			
1 to 5V DC	1 58			
0 to 5V DC	0 58			

(2) Input each set value.

Input each set value, referring to "5. Setup".

(3) Turn the load circuit power ON.

Control action starts so as to keep the control target at the SV.

7. Action explanation

7.1 OUT1 action

	Heating (reverse) action	Cooling (direct) action
Control action		
Relay contact output	<p>Cycle action is performed according to deviation.</p>	<p>Cycle action is performed according to deviation.</p>
Non-contact voltage output	<p>Cycle action is performed according to deviation.</p>	<p>Cycle action is performed according to deviation.</p>
DC current output	<p>Changes continuously according to deviation.</p>	<p>Changes continuously according to deviation.</p>
Indicator (OUT1) Green		

: Acts ON (lit) or OFF (unlit).

7.2 Heater burnout alarm action (option)

Heater burnout alarm action	
Heater burnout alarm output	
Indicator (HB) red	

When Heating/Cooling control (option) is applied, use terminals 12 and 13 for the Heater burnout alarm output.

7.3 OUT1 ON/OFF action

	Heating (reverse) action		Cooling (direct) action	
Control action				
Relay contact output				
Non-contact voltage output				
DC current output				
Indicator (OUT1) Green				

: Acts ON (lit) or OFF (unlit).

7.4 OUT2 (Heating/Cooling control) action (option)

Control action			
Relay contact output (OUT1)			
	Cycle action is performed according to deviation.		
Relay contact output (OUT2)			
	Cycle action is performed according to deviation.		
Non-contact voltage output (OUT1)			
	Cycle action is performed according to deviation.		
Non-contact voltage output (OUT2)			
	Cycle action is performed according to deviation.		
DC current output (OUT1)			
	Changes continuously according to deviation.		
DC current output (OUT2)			
	Changes continuously according to deviation.		
Indicator (OUT1) Green			
Indicator (OUT2) Yellow			

: Acts ON (lit) or OFF (unlit).

————— : Represents Heating control action.

- - - - - : Represents Cooling control action.

7.5 OUT2 (Heating/Cooling control) action (when setting Dead band)

Control action			
Relay contact output (OUT1)	<p>Cycle action is performed according to deviation.</p>		
Relay contact output (OUT2)	<p>Cycle action is performed according to deviation.</p>		
Non-contact voltage output (OUT1)	<p>Cycle action is performed according to deviation.</p>		
Non-contact voltage output (OUT2)	<p>Cycle action is performed according to deviation.</p>		
DC current output (OUT1)	<p>Changes continuously according to deviation.</p>		
DC current output (OUT2)	<p>Changes continuously according to deviation.</p>		
Indication (OUT1) Green			
Indication (OUT2) Yellow			

: Acts ON (lit) or OFF (unlit).

———— : Represents Heating control action.

----- : Represents Cooling control action.

7.6 OUT2 (Heating/Cooling control) action (when setting Overlap band)

Control action	
Relay contact output (OUT1)	<p>Cycle action is performed according to deviation.</p>
Relay contact output (OUT2)	<p>Cycle action is performed according to deviation.</p>
Non-contact voltage output (OUT1)	<p>Cycle action is performed according to deviation.</p>
Non-contact voltage output (OUT2)	<p>Cycle action is performed according to deviation.</p>
DC current output (OUT1)	<p>Changes continuously according to deviation.</p>
DC current output (OUT2)	<p>Changes continuously according to deviation.</p>
Indication (OUT1) Green	
Indication (OUT2) Yellow	

: Acts ON (lit) or OFF (unlit).

———— : Represents Heating control action.

----- : Represents Cooling control action.

7.7 A1, A2 action

	High limit alarm	Low limit alarm
Alarm action		
	High/Low limits alarm	High/Low limit range alarm
Alarm action		
	Process high alarm	Process low alarm
Alarm action		
	High limit alarm with standby	Low limit alarm with standby
Alarm action		
	High/Low limits alarm with standby	
Alarm action		

■ : Standby functions.

A2 output is turned ON when terminals 12 and 13 are connected.

A1 and A2 indicators light when their output terminals are connected (ON), and go off when they are not connected (OFF).

7.8 SV1/SV2 external selection action

	SV1	SV2
SV1/SV2 external selection		
Indicator Green	<div style="display: inline-block; border: 1px solid black; padding: 2px; margin-right: 10px;">SV1 Lit</div> <div style="display: inline-block; border: 1px solid black; padding: 2px;">SV2 Unlit</div>	<div style="display: inline-block; border: 1px solid black; padding: 2px; margin-right: 10px;">SV1 Unlit</div> <div style="display: inline-block; border: 1px solid black; padding: 2px;">SV2 Lit</div>

8. Control action explanations

8.1 PID

(1) Proportional band (P)

Proportional action is the action during which the control output varies in proportion to the deviation between the SV and the PV (processing temperature).

If the proportional band is narrowed, even if the output changes by a slight variation of the processing temperature, better control results can be obtained as the offset decreases.

However, if the proportional band is narrowed too much, even slight disturbances may cause variation in the processing temperature, control action changes to ON/OFF action and the so-called hunting phenomenon occurs.

Therefore, when the processing temperature comes to the balanced position near the SV and a constant temperature is maintained, the most suitable value is selected by gradually narrowing the proportional band while observing the control results.

(2) Integral time (I)

Integral action is used to eliminate offset. When the integral time is shortened, the returning speed to the set point is accelerated. However, the cycle of oscillation is also accelerated and the control becomes unstable.

(3) Derivative time (D)

Derivative action is used to restore the change in the processing temperature according to the rate of change. It reduces the amplitude of overshoot and undershoot width.

If the derivative time is shortened, restoring value becomes small, and if the derivative time is extended, an excessive returning phenomenon may occur and the control system may oscillate.

8.2 PID auto-tuning of this controller

In order to set each value of P, I, D and ARW automatically, the auto-tuning process should be made to fluctuate to obtain an optimal value.

Sometimes the auto-tuning process will not fluctuate if auto-tuning is performed at or near room temperature. Therefore auto-tuning might not finish normally.

(A) In the case of a large difference between the SV and processing temperature as the temperature is rising

When AT bias is set to 20°C, the AT process will fluctuate at the temperature 20°C lower than the SV.

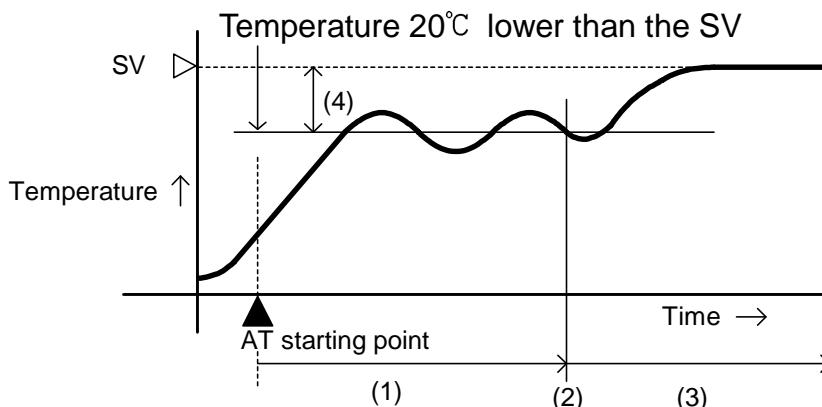

- (1) Calculating PID constant
- (2) PID constant calculated
- (3) Controlled by the PID constant set by auto-tuning.
- (4) AT bias value

(Fig. 8.2-1)

(B) In the case of a stable control

The AT process will fluctuate around the SV.

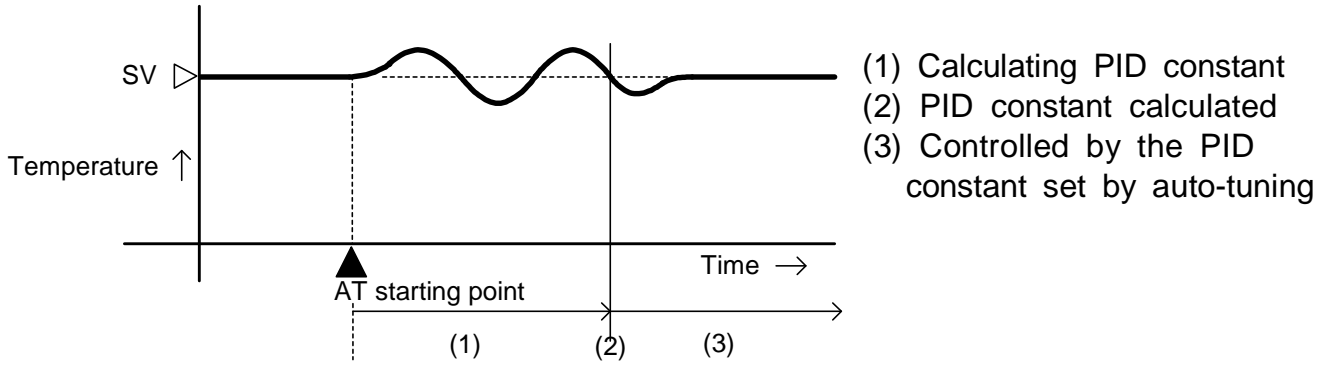

(Fig. 8.2-2)

(C) In the case of a large difference between the SV and processing temperature as the temperature is falling

When AT bias is set to 20°C, the AT process will fluctuate at the temperature 20°C higher than the SV.

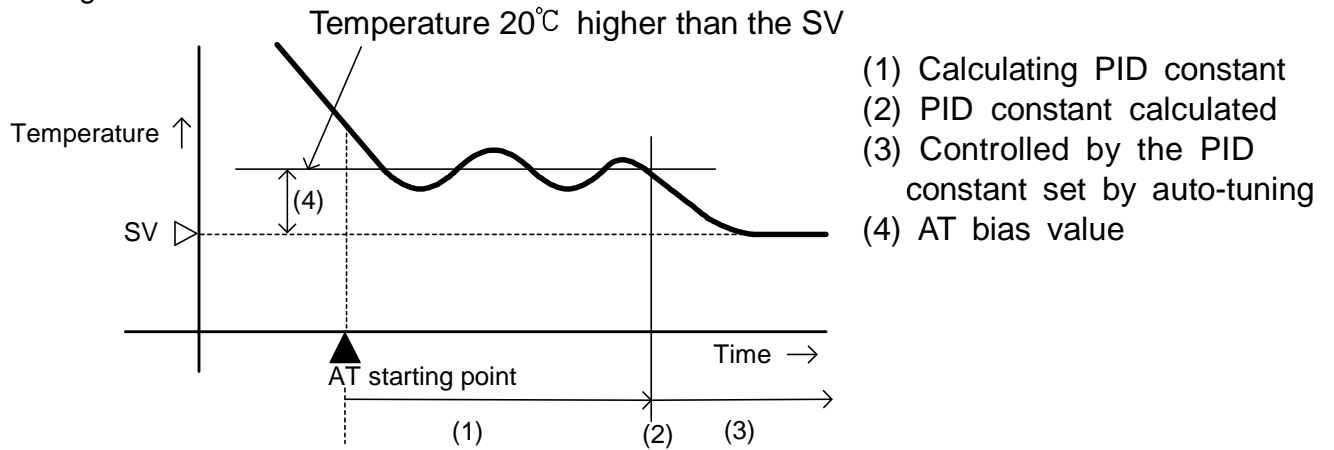

(Fig. 8.2.3)

8.3 Auto-reset (offset correction)

Auto-reset is performed to correct the offset at the point at which PV indication is stabilized within the proportional band during the PD action.

Since the corrected value is internally memorized, it is not necessary to perform the auto-reset again as long as the process is the same.

However, when the proportional band is set to 0, the corrected value is cleared.

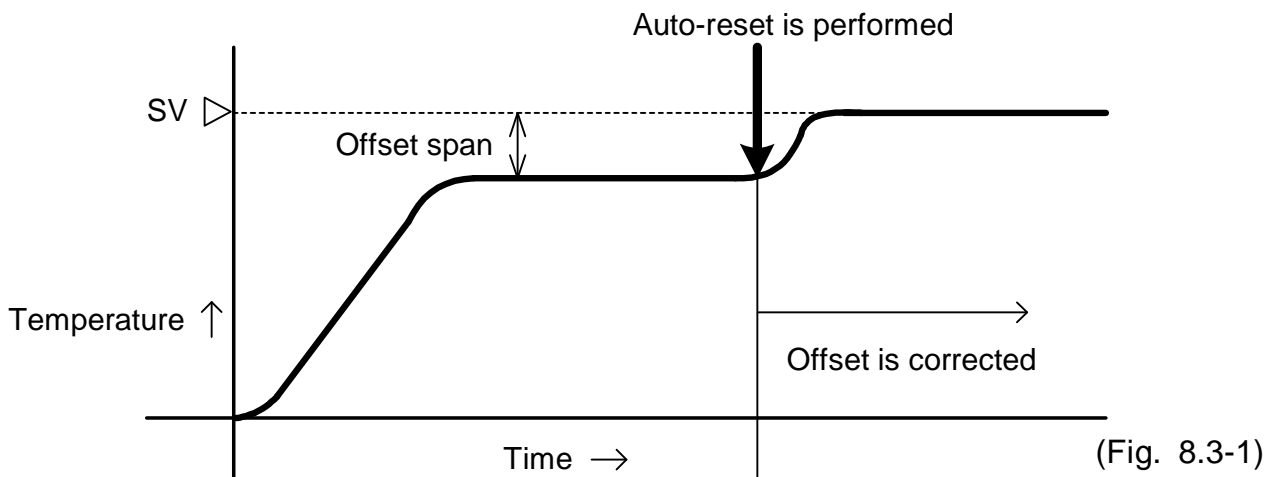

(Fig. 8.3-1)

9. Specifications

9.1 Standard specifications

Mounting : Flush

Setting : Membrane sheet key

Display

PV display : Red LED 4 digits, character size, 18 x 8 (H x W)mm

SV display : Green LED 4 digits, character size, 13.2 x 6 (H x W)mm

Accuracy (Setting, indication)

Thermocouple : Within $\pm 0.2\%$ of each input span ± 1 digit or within $\pm 2^{\circ}\text{C}$ (4°F), whichever is greater

However, for R, S input, 0 to 200°C (0 to 400°F): Within $\pm 6^{\circ}\text{C}$ (12°F)

B input, 0 to 300°C (0 to 600°F): Accuracy is not guaranteed.

K, J, E, T, N input, less than 0°C (32°F): Within $\pm 0.4\%$ of each input span ± 1 digit

RTD : Within $\pm 0.1\%$ of each input span ± 1 digit or within $\pm 1^{\circ}\text{C}$ (2°F), whichever is greater

DC current, voltage: Within $\pm 0.2\%$ of each input span ± 1 digit

Rated input

Input type	Input range		Resolution
K	-200 to 1370°C	-320 to 2500°F	1°C ($^{\circ}\text{F}$)
	-199.9 to 400.0°C	-199.9 to 750.0°F	0.1°C ($^{\circ}\text{F}$)
J	-200 to 1000°C	-320 to 1800°F	1°C ($^{\circ}\text{F}$)
R	0 to 1760°C	0 to 3200°F	1°C ($^{\circ}\text{F}$)
S	0 to 1760°C	0 to 3200°F	1°C ($^{\circ}\text{F}$)
B	0 to 1820°C	0 to 3300°F	1°C ($^{\circ}\text{F}$)
E	-200 to 800°C	-320 to 1500°F	1°C ($^{\circ}\text{F}$)
T	-199.9 to 400.0°C	-199.9 to 750.0°F	0.1°C ($^{\circ}\text{F}$)
N	-200 to 1300°C	-320 to 2300°F	1°C ($^{\circ}\text{F}$)
PL-II	0 to 1390°C	0 to 2500°F	1°C ($^{\circ}\text{F}$)
C(W/Re5-26)	0 to 2315°C	0 to 4200°F	1°C ($^{\circ}\text{F}$)
Pt100	-199.9 to 850.0°C	-199.9 to 999.9°F	0.1°C ($^{\circ}\text{F}$)
	-200 to 850°C	-300 to 1500°F	1°C ($^{\circ}\text{F}$)
JPt100	-199.9 to 500.0°C	-199.9 to 900.0°F	0.1°C ($^{\circ}\text{F}$)
	-200 to 500°C	-300 to 900°F	1°C ($^{\circ}\text{F}$)
4 to 20mA DC	-1999 to 9999 *1 *2		1
0 to 20mA DC			
0 to 1V DC	-1999 to 9999 *1		1
0 to 10V DC			
1 to 5V DC			
0 to 5V DC			

*1: For DC input, input range and decimal point place are changeable.

*2: 50Ω shunt resistor (AKT4810, sold separately) must be connected between input terminals.

Input sampling period : 0.25 seconds

Input

Thermocouple	: K, J, R, S, B, E, T, N, PL-II, C (W/Re5-26) External resistance, 100Ω or less, however, for B, 40Ω or less
RTD	: Pt100, JPt100, 3-wire system Allowable input lead wire resistance, 10Ω or less per wire
DC current	: 0 to 20mA DC, 4 to 20mA DC Input impedance, 50Ω [50Ω shunt resistor (AKT4810, sold separately) must be connected between input terminals] Allowable input current 50mA or less [If 50Ω shunt resistor (AKT4810, sold separately) is used]
DC voltage	: 0 to 1V DC Input impedance, 1MΩ or more Allowable input voltage 5V or less Allowable signal source resistance 2kΩ or less 0 to 10V DC, 0 to 5V DC, 1 to 5V DC Input impedance, 100kΩ or more Allowable input voltage 15V DC or less Allowable signal source resistance 100Ω or less

Control output (OUT1)

Relay contact	: 1a1b Control capacity, 3A 250V AC (resistive load) 1A 250V AC (inductive load $\cos\phi=0.4$) Electrical life, 100,000 cycles
Non-contact voltage	: 12 ⁺² ₀ V DC maximum 40mA (short circuit protected)
DC current	: 4 to 20mA DC Load resistance, maximum 550Ω

A1 output

When A1 action is set as Energized, the alarm action point is set by \pm deviation from the SV (except Process alarm).	
When the input is out of the range, the output turns ON or OFF (in the case of High/Low limit range alarm).	
When the alarm action is set as Deenergized, the output acts conversely.	
Setting accuracy : The same as the Indication accuracy	
Action	: ON/OFF action
Hysteresis	: Thermocouple, RTD input, 0.1 to 100.0°C (°F) DC current, voltage input, 1 to 1000 (The placement of the decimal point follows the selection)
Output	: Relay contact 1a Control capacity, 3A 250V AC (resistive load) Electrical life, 100,000 cycles

Control action

- PID action (with auto-tuning function)
- PI action: When derivative time is set to 0
- PD action (with auto-reset function): When integral time is set to 0
- P action (with auto-reset function): When integral and derivative times are set to 0

- ON/OFF action: When OUT1 proportional band is set to 0
 OUT1 proportional band (P)
 Thermocouple: 0 to 1000°C (0 to 2000°F)
 RTD: 0.0 to 999.9°C (0.0 to 999.9°F)
 DC current, voltage: 0.0 to 100.0%
 (ON/OFF action when set to 0°C(°F), 0.0°C(°F) or 0.0%)
 Integral time (I) : 0 to 1000sec (Off when set to 0)
 Derivative time (D) : 0 to 300sec (Off when set to 0)
 OUT1 proportional cycle : 1 to 120sec (Not available for DC current output type)
 ARW : 0 to 100%
 OUT1 hysteresis : Thermocouple, RTD input: 0.1 to 100.0°C (°F)
 DC current, voltage input: 1 to 1000 (The placement of the decimal point follows the selection)

SV1/SV2 external selection: SV1 and SV2 can be selected by external contact.

Contact open between terminals 14 and 17 : SV1

Contact closed between terminals 14 and 17: SV2

Contact current: 6mA

Supply voltage : 100 to 240V AC 50/60Hz, 24V AC/DC 50/60Hz

Allowable voltage fluctuation range

100 to 240V AC : 85 to 264V AC

24V AC/DC : 20 to 28V AC/DC

Ambient temperature: 0 to 50°C (32 to 122°F)

Ambient humidity : 35 to 85%RH (no condensation)

Power consumption : Approx. 8VA

Circuit insulation configuration

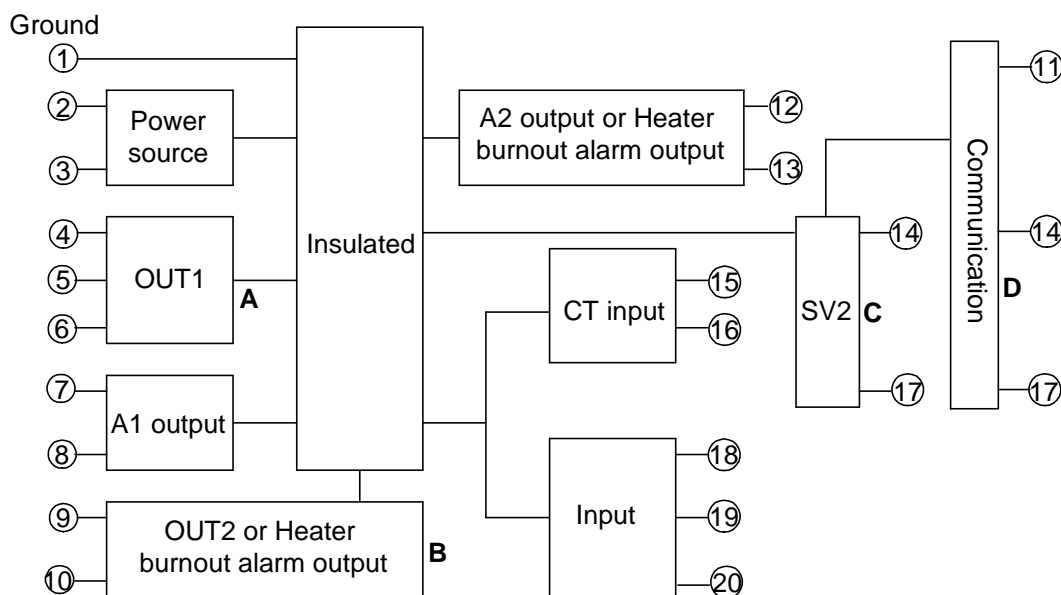

- When OUT1 is non-contact voltage or DC current output type and OUT2 is Non-contact voltage or DC current output type, A is not insulated from B.
- When OUT1 is non-contact voltage or DC current output type, A is not insulated from C, and A is not insulated from D.
 When OUT2 is non-contact voltage or DC current output type, B is not insulated from C, and B is not insulated from D.

Insulation resistance

10MΩ or more, at 500V DC for other combinations except the above mentioned

Dielectric strength

Between input terminal and ground terminal, 1.5kV AC for 1 minute
 Between input terminal and power terminal, 1.5kV AC for 1 minute
 Between output terminal and ground terminal, 1.5kV AC for 1 minute
 Between output terminal and power terminal, 1.5kV AC for 1 minute
 Between power terminal and ground terminal, 1.5kV AC for 1 minute

Weight : Approx. 370g

External dimension: 96 x 96 x 98.5mm (W x H x D)

Material : Case, Flame-resistant resin

Color : Case, Ash gray

Attached function

[Sensor correction function]

[Set value lock function]

[Input abnormality indication]

Output selection when input abnormal	Contents and Indication	Output status			
		OUT1		OUT2	
		Direct action	Reverse action	Direct action	Reverse action
ON	Overscale Measured value has exceeded Indication range high limit value. "----" flashes.	ON (20mA) or OUT1 high limit value (*)	OFF (4mA) or OUT1 low limit value	OFF (4mA) or OUT2 low limit value	ON (20mA) or OUT2 high limit value(*)
OFF		OFF (4mA) or OUT1 low limit value			OFF (4mA) or OUT2 low limit value
ON	Underscale Measured value has dropped below Indication range low limit value. "----" flashes.	OFF (4mA) or OUT1 low limit value	ON (20mA) or OUT1 high limit value (*)	ON (20mA) or OUT2 high limit value (*)	OFF (4mA) or OUT2 low limit value
OFF			OFF (4mA) or OUT1 low limit value	OFF (4mA) or OUT2 low limit value	

Only for DC input and DC current output type, [Output status selection when input abnormal] is available. For other inputs and outputs except for DC input and DC current output, the output status will be the same one as when OFF is selected during [Output status selection when input abnormal].

For manual control, the preset manipulated variable (MV) is outputted.

(*): Outputs a value between OFF (4mA) and ON (20mA) or between OUT1 (OUT2) low limit value and OUT1 (OUT2) high limit value, depending on deviation.

Thermocouple, RTD input:

Input	Input range	Indication range	Control range
K, T	-199.9 to 400.0°C	-199.9 to 450.0°C	-205.0 to 450.0°C
	-199.9 to 750.0°F	-199.9 to 850.0°F	-209.0 to 850.0°F
Pt100	-199.9 to 850.0°C	-199.9 to 900.0°C	-210.0 to 900.0°C
	-200 to 850°C	-210 to 900°C	-210 to 900°C
	-199.9 to 999.9°F	-199.9 to 999.9°F	-211.0 to 1099.9°F
JPt100	-300 to 1500°F	-318 to 1600°F	-318 to 1600°F
	-199.9 to 500.0°C	-199.9 to 550.0°C	-206.0 to 550.0°C
	-200 to 500°C	-207 to 550°C	-207 to 550°C
	-199.9 to 900.0°F	-199.9 to 999.9°F	-211.0 to 999.9°F
	-300 to 900°F	-312 to 1000°F	-312 to 1000°F

For the thermocouple inputs other than the above, both the Indication range and Control range are: Input range low limit value - 50°C (100°F) to Input range high limit value + 50°C (100°F)

- **DC input**

Indication range : [Scaling low limit value – Scaling span x 1%] to [Scaling high limit value + Scaling span x 10%]

However, if the input value goes out of the range –1999 to 9999, the PV display flashes “- - - -” or “- - - -”.

Control range : [Scaling low limit value – Scaling span x 1%] to [Scaling high limit value + Scaling span x 10%]

- **DC input disconnection:** When DC input is disconnected, PV display flashes

“- - - -” for 4 to 20mA DC and 1 to 5V DC inputs, and

“- - - -” for 0 to 1V DC input.

For 0 to 20mA DC, 0 to 5V DC and 0 to 10V DC inputs, the PV display indicates the value corresponding with 0mA or 0V input.

[Burnout]

When the thermocouple or RTD input is burnt out, OUT1 is turned off (for DC current output type, OUT1 low limit value) and the PV display flashes “- - - -”.

[Self-diagnosis]

The CPU is monitored by a watchdog timer, and when an abnormal status is found on the CPU, the controller is switched to warm-up status.

[Automatic cold junction temperature compensation](Thermocouple input type)

This detects the temperature at the connecting terminal between thermocouple and the instrument, and always maintains the same status as when the reference junction is located at 0°C (32°F).

[Power failure countermeasure]

The setting data is backed up in non-volatile IC memory.

[Warm-up indication]

All outputs are turned OFF in the warm-up status.

With thermocouple and RTD input, for approx. 3 seconds after the power is switched ON, sensor input characters and temperature unit are indicated on the PV display, and the input range high limit value is indicated on the SV display.

With the DC input, for approx. 3 seconds after the power is switched ON, sensor input characters are indicated on the PV display, and scaling high limit value is indicated on the SV display.



(However, if the scaling high limit value has been changed during the Scaling high limit setting, the changed value will be indicated on the SV display.)

[Auto/Manual control switching]

If Auto/Manual control function is selected during OUT/OFF key function selection, automatic control can be switched to manual control and vice versa by pressing the OUT/OFF key.

When the control action is changed from automatic to manual control and vice versa, the balanceless-bumpless function works to prevent sudden change of manipulated variable.

When the control action is changed from automatic to manual control, the 1st decimal point from the right on the SV display flashes.

The manipulated variable (MV) on the SV display can be increased or decreased by pressing the  or  key and the control is performed.

(When the power supply to the instrument is turned on, automatic control starts)

Accessories included: Instruction manual 1 copy
 Screw type mounting brackets 1 set
 CT (current transformer)
 For rating 5A, 10A, 20A : AKT4815 1 piece
 For rating 50A : AKT4816 1 piece

Accessories sold separately:

Terminal cover (AKT9801) 1 piece
 50Ω shunt resistor (AKT4810) 1 piece

9.2 Optional specifications

Alarm 2 (A2)

When A2 action is set as Energized, the alarm action point is set by ±deviation from OUT1 SV (except Process alarm).

When the input is out of the range, the output turns ON or OFF (in the case of High/Low limit range alarm).

When the alarm action is set as Deenergized, the output acts conversely.

When A2 option is added, one more option Heater burnout alarm or Heating/Cooling control can be added.

Setting accuracy: The same as the Indicating accuracy

Action : ON/OFF action

Hysteresis : Thermocouple, RTD input, 0.1 to 100.0°C (°F)
 DC current, voltage input, 1 to 1000
 (The placement of the decimal point follows the selection)

Output : Relay contact, 1a
 Control capacity, 3A 250V AC (resistive load)
 Electrical life, 100,000 cycles

HB (Heater burnout alarm)

Watches the heater current with CT (current transformer), and detects the heater burnout.

Heater burnout alarm is activated when sensor is burnt out or when indication is overscale or underscale. (To detect Heater burnout, a CT for 50A can also be used for 5A, 10A and 20A ratings, however, this is not suitable for small ampere ratings due to a low degree of accuracy. For a 20A rating or less, use a CT designated for 20A.)

- When the Heater burnout alarm option is applied, one more option A2 output or Heating/Cooling control can be added.
- This option cannot be applied to DC current output type.

Heater rated current: 5A, 10A, 20A, 50A, Must be specified

Setting accuracy : Within ±5% of heater rated current

Action : ON/OFF action

Output : Relay contact, 1a
 Control capacity, 3A 250V AC (resistive load)
 Electrical life, 100,000 cycles

Heating/Cooling control

When the Heating/Cooling control option is added, one more option A2 output or Heater burnout alarm can be added.

OUT2 proportional band : 0.0 to 10.0 times OUT1 proportional band
 (ON/OFF action when set to 0.0)

OUT2 integral time : The same as that of OUT1

OUT2 derivative time : The same as that of OUT1

OUT2 proportional cycle : 1 to 120 seconds

Overlap band/Dead band:

Thermocouple, RTD input: -100.0 to 100.0°C (°F)
 DC current, voltage input: -1000 to 1000 (The placement of the decimal point follows the selection)

OUT2 ON/OFF action hysteresis:

Thermocouple, RTD input: 0.1 to 100.0°C (°F)

DC current, voltage input: 1 to 1000 (The placement of the decimal point follows the selection)

Output Relay contact, 1a

Control capacity, 3A 250V AC (resistive load)

1A 250V AC (inductive load $\cos\phi=0.4$)

Electrical life, 100,000 cycles

Non-contact voltage output

12⁺²₀V DC maximum 40mA (short circuit protected)

DC current output, 4 to 20mA DC

Load resistance, maximum 550Ω

OUT2 action mode selection function:

One cooling mode can be selected by keypad operation from the following.

Air cooling (Linear characteristic)

Oil cooling (1.5th power of the linear characteristic)

Water cooling (2nd power of the linear characteristic)

Serial communication

The following operations can be carried out from the external computer.

When this option is added, SV2 setting is not available.

(1) Reading and setting of SV, PID and various set values

(2) Reading of the PV and action status

(3) Change of the functions

Cable length : Max. communication distance 1000m,
Cable resistance; Within 50Ω

Communication line : EIA RS-485

Communication method : Half-duplex communication start stop synchronous

Communication speed : 2400, 4800, 9600, 19200bps (Selectable by keypad)

Parity : Even, Odd and No parity (Selectable by keypad)

Stop bit : 1, 2 (Selectable by keypad)

Communication protocol : Modbus RTU, Modbus ASCII (Selectable by keypad)

Connectable number of units : Maximum 31 units to 1 host computer

Communication error detection: Parity, checksum (LRC, CRC)

10. Troubleshooting

If any malfunctions occur, refer to the following items after checking the power of the controller.



Warning





Turn the power supply to the instrument off before wiring or checking.
Working on or touching the terminal with the power switched on may result in severe injury or death due to Electric Shock.

10.1 Indication

Problem	Presumed cause and solution
The PV display is indicating [OFF].	<ul style="list-style-type: none"> Control output OFF function is working. Press the OUT/OFF key for approx. 1 second to release the function.
[----] is flashing on the PV display.	<ul style="list-style-type: none"> Burnout of thermocouple, RTD or disconnection of DC voltage (0 to 1V DC). Change each sensor. How to check whether the sensor is burnt out [Thermocouple] If the input terminals of the instrument are shorted, and if a value around room temperature is indicated, the instrument is likely to be operating normally, however, the sensor may be burnt out. [RTD] If approx. 100Ω of resistance is connected to the input terminals between A-B of the instrument and between B-B is shorted, and if a value around 0°C (32°F) is indicated, the instrument is likely to be operating normally, however, the sensor may be burnt out. [DC voltage (0 to 1V DC)] If the input terminals of the instrument are shorted, and if a scaling low limit value is indicated, the instrument is likely to be operating normally, however, the signal wire may be disconnected. Check whether the input terminals of thermocouple, RTD or DC voltage (0 to 1V DC) are securely mounted to the instrument input terminal. Connect the sensor terminals to the instrument input terminals securely.
[----] is flashing on the PV display.	<ul style="list-style-type: none"> The input signal wire for DC voltage (1 to 5V DC) or DC current (4 to 20mA DC) may be disconnected. Replace the input signal wire. How to check whether the input signal wire is disconnected [DC voltage (1 to 5V DC)] If the input to the input terminal of this controller is 1V DC and if scaling low limit value is indicated, the controller is likely to be operating normally, however, the input signal wire may be disconnected. [DC current (4 to 20mA DC)] If the input to the input terminal of this controller is 4mA DC and scaling low limit value is indicated, the controller is likely to be operating normally, however, the input signal wire may be disconnected. Check whether the input signal wire of DC voltage (1 to 5V DC) and DC current (4 to 20mA DC) is securely connected to the input terminal of this controller. Ensure that they are wired properly. Check whether the polarity of thermocouple or compensating lead wire is correct. Check whether codes (A, B, B) of the RTD agree with the controller terminal. Ensure that they are wired properly.

Problem	Presumed cause and solution
<p>The value set during the Scaling low limit setting remains on the PV display.</p>	<ul style="list-style-type: none"> • Check whether the input signal wire for DC voltage (0 to 5V DC, 0 to 10V DC) or DC current (0 to 20mA DC) is disconnected. How to check whether the input signal wire is disconnected [DC voltage (0 to 5V DC, 0 to 10V DC)] If the input to the input terminal of this controller is 1V DC and if a value corresponding to 1V DC is indicated, the controller is likely to be operating normally, however, the input signal wire may be disconnected. [DC current (0 to 20mA DC)] If the input to the input terminal of this controller is 1mA DC and if a value corresponding to 1mA DC is indicated, the controller is likely to be operating normally, however, the input signal wire may be disconnected. • Check whether the input lead wire terminals for DC voltage (0 to 5V DC, 0 to 10V DC) or DC current (0 to 20mA DC) are securely connected to the instrument input terminals.
<p>The indication of PV display is abnormal or unstable.</p>	<ul style="list-style-type: none"> • Check whether the sensor input and temperature unit (°C or °F) setting are correct. Set the sensor input and the temperature unit properly. • Sensor correcting value is unsuitable. Set it to a suitable value. • Sensor specification is improper. Set the sensor specification properly. • AC may be leaking into the sensor circuit. Use an ungrounded type sensor. • There may be equipment that interferes with or makes noise near the controller. Keep equipment that interferes with or makes noise away from the controller.
<p>[Error] is indicated on the PV display.</p>	<p>The internal memory is defective. Please contact our main office or dealers.</p>

10.2 Key operation

Problem	Presumed cause and solution
<p>Unable to set SV, P, I, D, proportional cycle, alarm value, etc. The value does not change by the ,  keys.</p>	<ul style="list-style-type: none"> • Set value lock (Lock 1 or Lock 2) is selected. Release the lock selection. • During PID auto-tuning or auto-reset. Cancel the auto-tuning if necessary. Auto-reset ends 4 minutes after starting.
<p>The setting indication does not change within the input range even if the ,  keys are pressed, and new values are unable to be set.</p>	<ul style="list-style-type: none"> • SV high limit or low limit may be set at the point where the value does not change. Set it to a suitable value while in Auxiliary function setting mode 1.

10.3 Control

Problem	Presumed cause and solution
Temperature does not rise.	<ul style="list-style-type: none"> The sensor is out of order. Replace the sensors. Check whether the sensor is securely mounted to the instrument input terminal. Check whether control output terminals are securely mounted to the actuator input terminals. Mount the sensor or control output terminal securely. Check whether the wiring of sensor or control output terminals is correct.
The control output remains ON status.	<ul style="list-style-type: none"> OUT1 low limit value is set to 100% or higher in Auxiliary function setting mode 2. Set it to a suitable value while in Auxiliary function setting mode 2.
The control output remains OFF status.	<ul style="list-style-type: none"> OUT1 high limit value is set to 0% or less in Auxiliary function setting mode 2. Set it to a suitable value while in Auxiliary function setting mode 2.

If any unexplained malfunctions occur, make inquiries at our agency or us.

11. Character table

Photocopiable material

[Main setting mode]

Character	Setting item	Default value	Data
L	SV1	0°C	
L2	SV2	0°C	

[Sub setting mode]

Character	Setting item	Default value	Data
AT	AT	----	
r4ET	Auto-reset		
P	OUT1 proportional band	10°C	
P_b	OUT2 proportional band	1.0 times	
I	Integral time	200 seconds	
d	Derivative time	50 seconds	
n	ARW	50%	
c	OUT1 proportional cycle	Relay contact output: 30sec Non-contact voltage output: 3sec	
c_b	OUT2 proportional cycle	Relay contact output: 30sec Non-contact voltage output: 3sec	
A1	A1 value	0°C	
A2	A2 value	0°C	
H	HB (Heater burnout alarm) value	0.0A	

[Auxiliary function setting mode 1]

Character	Setting item	Default value	Data
<i>Lact</i>	Set value lock	Unlock	
<i>4H</i>	SV high limit	1370°C	
<i>4L</i>	SV low limit	-200°C	
<i>4a</i>	Sensor correction	0.0°C	
<i>c4L</i>	Communication protocol	Modbus ASCII	
<i>c4a</i>	Instrument number	0	
<i>c4P</i>	Communication speed	9600bps	
<i>c4Pr</i>	Parity	Even	
<i>c4r</i>	Stop bit	1	

[Auxiliary function setting mode 2]

Character	Setting item	Default value	Data
<i>4En4</i>	Input type	K: -200 to 1370°C	
<i>4FLH</i>	Scaling high limit	9999	
<i>4FLl</i>	Scaling low limit	-1999	
<i>dP</i>	Decimal point place	No decimal point	
<i>FILF</i>	PV filter time constant	0.0 seconds	
<i>oLH</i>	OUT1 high limit	100%	
<i>oLL</i>	OUT1 low limit	0%	
<i>H44</i>	OUT1 ON/OFF action hysteresis	1.0°C	
<i>cRcF</i>	OUT2 action mode	Air cooling	
<i>oLHb</i>	OUT2 high limit	100%	
<i>oLLb</i>	OUT2 low limit	0%	
<i>db</i>	Overlap band/Dead band	0.0°C	
<i>H44b</i>	OUT2 ON/OFF action hysteresis	1.0°C	
<i>AL1F</i>	A1 type	No alarm action	
<i>AL2F</i>	A2 type	No alarm action	
<i>AL1a</i>	A1 action Energized/Deenergized	Energized	
<i>AL2a</i>	A2 action Energized/Deenergized	Energized	
<i>A1H4</i>	A1 hysteresis	1.0°C	
<i>A2H4</i>	A2 hysteresis	1.0°C	
<i>A1d4</i>	A1 action delayed timer	0 seconds	
<i>A2d4</i>	A2 action delayed timer	0 seconds	
<i>conF</i>	Direct (Cooling)/Reverse (Heating) control action	Reverse (Heating) action	
<i>AT_b</i>	AT bias	20°C	
<i>48_b</i>	Setting item not used		
<i>48_2</i>	SV2 indication	Indication	
<i>EoUF</i>	Output status selection when input abnormal	Output OFF	
<i>AAaU</i>	OUT/OFF key function	OUT/OFF function	

If you have any inquiries, please consult our agency or the shop where you purchased the unit.

Panasonic Industrial Devices SUNX Co., Ltd.

<http://panasonic.net/id/pidsx/global>

Overseas Sales Division (Head Office)

2431-1 Ushiyama-cho, Kasugai-shi, Aichi, 486-0901, Japan

Phone: +81-568-33-7861 FAX: +81-568-33-8591

About our sale network, please visit our website.

PRINTED IN JAPAN © Panasonic Industrial Devices SUNX Co., Ltd. 2012

Pursuant to the directive 2004/108/EC, article 9(2)

Panasonic Electric Works Europe AG

Rudolf-Diesel-Ring 2 83607 Holzkirchen, Germany

This product has been developed / produced for industrial use only.

No. KT91E7 2013.05